

222

Dieses Buch gibt allen Kindern weitere interessante Anregungen für das Spiel mit den LEGO Steinen.

Kinder haben eine lebhaft Phantasie, aber sie benötigen auch Modellvorschläge, um neue Ideen zu verwirklichen. Das Baubuch ist für Jungen und Mädchen gleichermaßen gedacht. Es beginnt mit einfachen Modellen für die Kleinen und endet mit schwierigen Konstruktionen für LEGO »Profis«.

Alle abgebildeten Modelle variieren sowohl in der Farbe als auch in der Größe, um Kindern mit kleinen und großen LEGO Sammlungen Ideen zu vermitteln.

Children have a very lively imagination but sometimes they need fresh ideas to spark them off. That is when this book will come in handy.

Perhaps they will copy a model brick for brick. Perhaps they will get an idea for a similar model of their own design. Quite often they will start to copy a model and then change it half way through to suit their own ideas or the bricks available, for the models shown are not necessarily built from particular sets.

There are small, simple models in the first pages, progressing to larger, more complex designs towards the end for boys and girls with more experience of LEGO building and with larger collections.

Med denna byggeidébok vill vi ge barnen ytterligare impulser till lek med sin LEGO samling.

Barn har livlig fantasi, men de har också behov av att bli inspirerade till hur de skall bygga och leka.

Idéboken passar för både flickor och pojkar. Den visar först ganska enkla modeller för de allra minsta och sedan kommer svårare modeller för erfarna LEGO byggare.

Bokens modeller är varierande i såväl färger som storlek, vilket gör att den innehåller idéer för både stora och små LEGO samlingsgar.

Con este libro de ideas queremos dar a los niños nuevos impulsos para que sigan creando con su colección LEGO.

Los niños poseen una imaginación desbordante, pero aun así necesitan inspirarse para construir y jugar.

Este libro está pensado para niños y niñas. Comienza con modelos muy sencillos para los pequeños y termina con modelos bastante difíciles para los aventajados expertos en LEGO. Los modelos del libro varían en colores y tamaños, por lo que hay ideas tanto para las colecciones pequeñas como para las grandes.

Dette brochure a pour but de renouveler l'intérêt des enfants pour leur collection LEGO, en leur apportant de nouvelles idées de jeux.

Les enfants ont une imagination débordante, mais ils ont aussi besoin d'une source d'inspiration pour créer et jouer. La brochure est destinée aussi bien aux garçons qu'aux filles. Elle propose d'abord des constructions faciles pour les très petits, et donne ensuite des exemples plus élaborés pour les constructeurs expérimentés.

La variété de couleurs et de tailles des éléments permet donc de nombreuses variantes de constructions, que l'on peut réaliser à partir d'une petite ou d'une grande collection de LEGO.

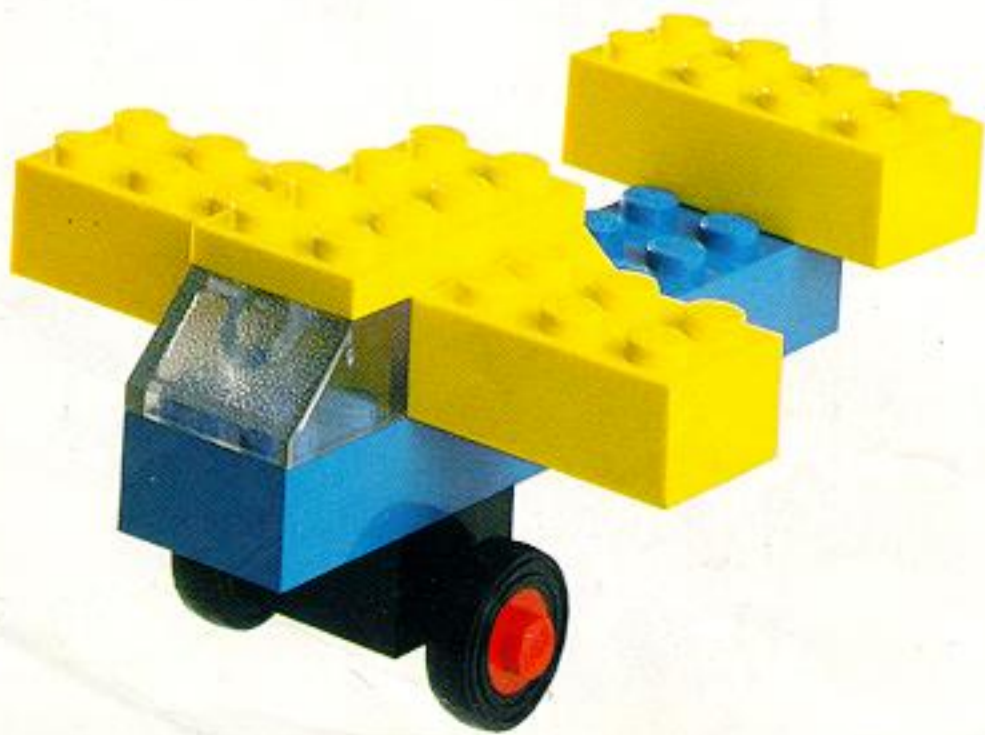

Med denne byggebog vil vi gerne give børn yderligere impulser til leg med deres LEGO samling.

Børn har en sprudlende fantasi, men de har også behov for at blive inspireret til, hvad de skal bygge og lege.

Bogen er både til drenge og piger. Den begynder med ganske enkle modeller til de helt små og slutter med ret svære modeller til erfarne LEGO byggere. Bogens modeller er varierede både i farver og størrelse, så der er ideer til både små og store LEGO samlinger.

Dit boek met bouwvoorbeelden moedigt kinderen aan om met hun LEGO verzameling nieuwe wegen in te slaan.

Hun fantasie en creativiteit komt steeds in een ander stadium. Daarom hebben zij doorlopend behoefte aan nieuwe inspiratie om eigen talenten verder te ontdekken en te ontwikkelen.

Dit boek is zowel voor jongens als voor meisjes. Het begint met eenvoudige ideeën voor jonge kinderen en eindigt met moeilijke modellen voor hen die reeds lang met LEGO spelen.

Con questo catalogo cerchiamo di dare nuove idee ai bambini per giocare meglio con la loro collezione LEGO.

I bambini possiedono una fantasia illimitata, ma hanno spesso bisogno di qualche suggerimento su cosa costruire. Il catalogo è per bambini e bambine.

Comincia con modelli abbastanza semplici per bambini piccoli e termina con modelli molto più difficili per esperti costruttori LEGO.

Ci sono modelli di piccole dimensioni ed altri più grandi, perciò può essere usato sia da piccoli che da grandi collezionisti.

子どもたちは、とてもいきいきとした想像力をもっていますが、ときにはそれを触発してあげるために、新鮮なアイデアが必要になるものです。そんなとき、この本が役に立ちます。たぶん子どもたちは、手本どおりブリックを1つひとつ積みかさねていくでしょう。そのうち、あるアイデアを思い付き、同じような形をしているけれど、自分で考えたものをつくるようになります。つまり、最初は手本をまね、途中で自分自身のアイデアやもっているブリックに合ったものをつくるようになるわけです。というのは、示してある手本は必ずしも特定のセットで組み立てたものではないからです。始めの方のページには、小さくて簡単な手本が示してありますが、終りの方になるに従って、レゴ遊びに経験をつみ多くの作り方を知っている子どもたちのために、さらに大きくて複雑な形をしたものが示してあります。

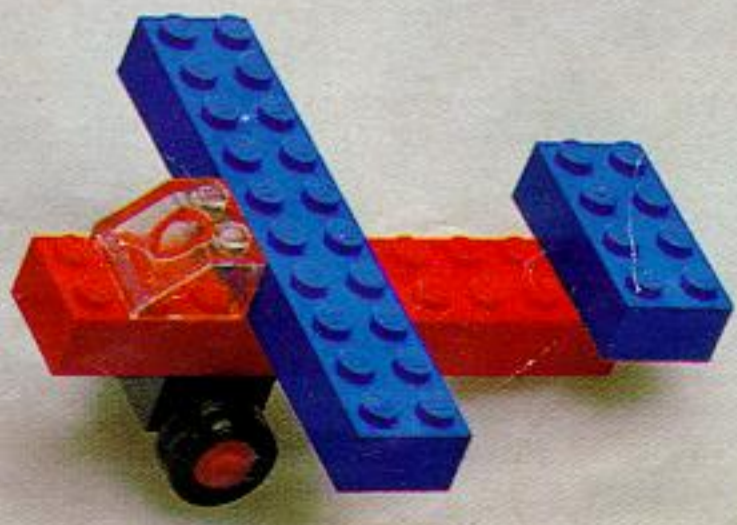
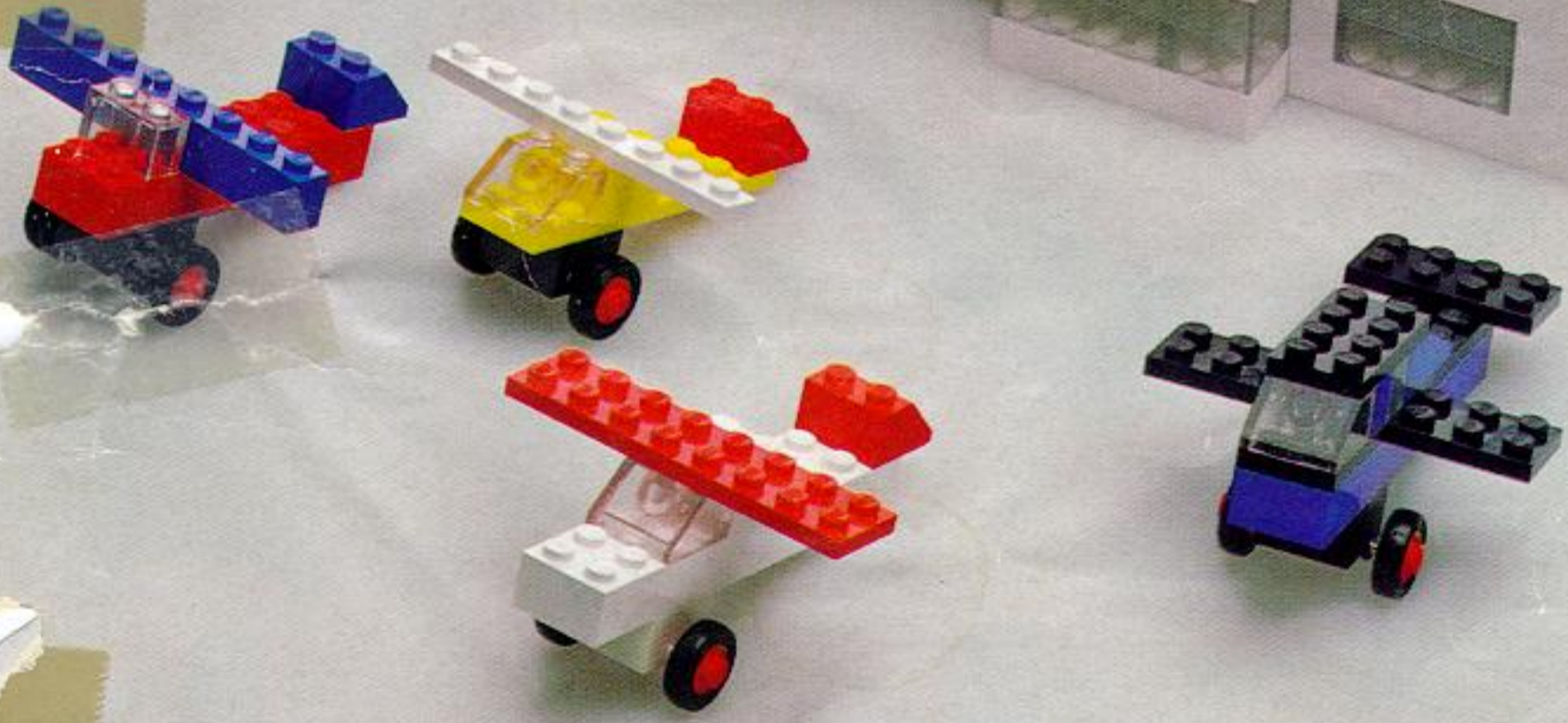
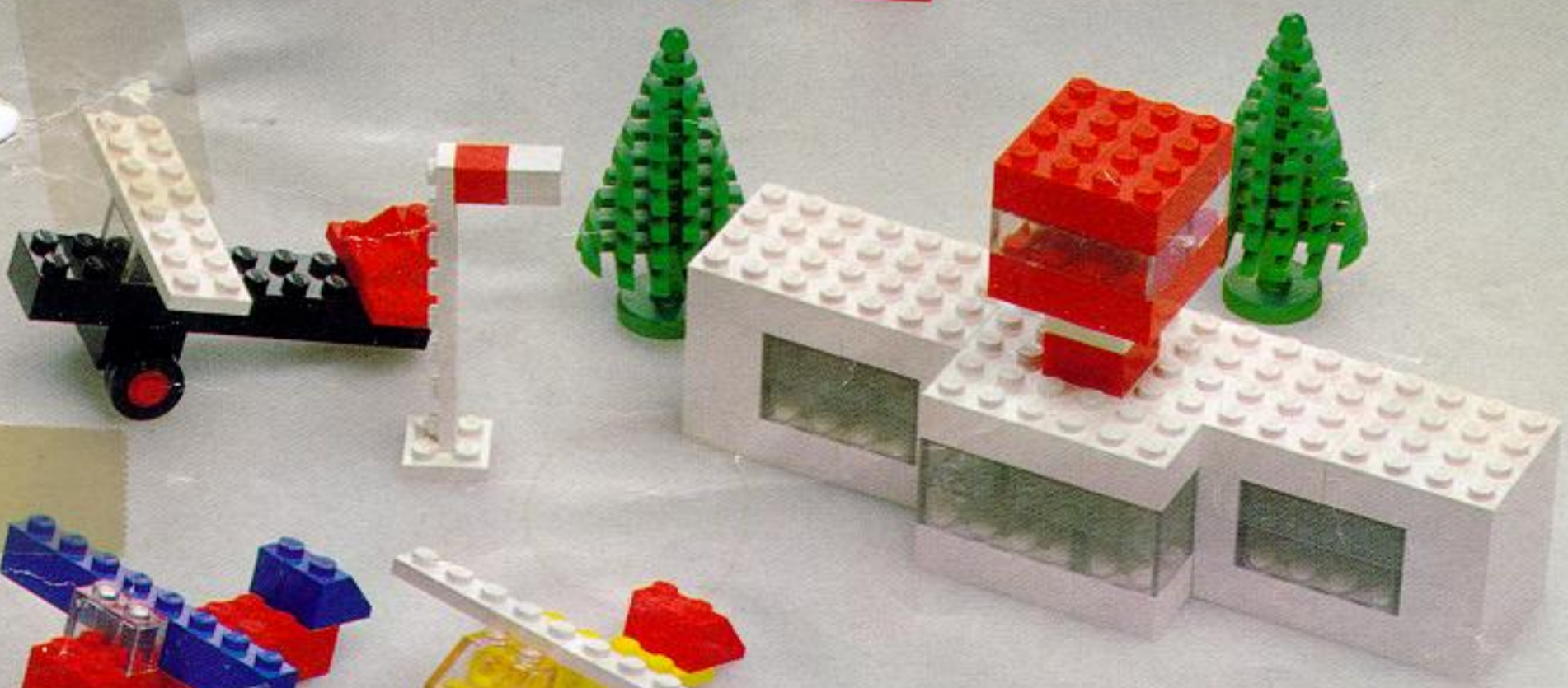

2

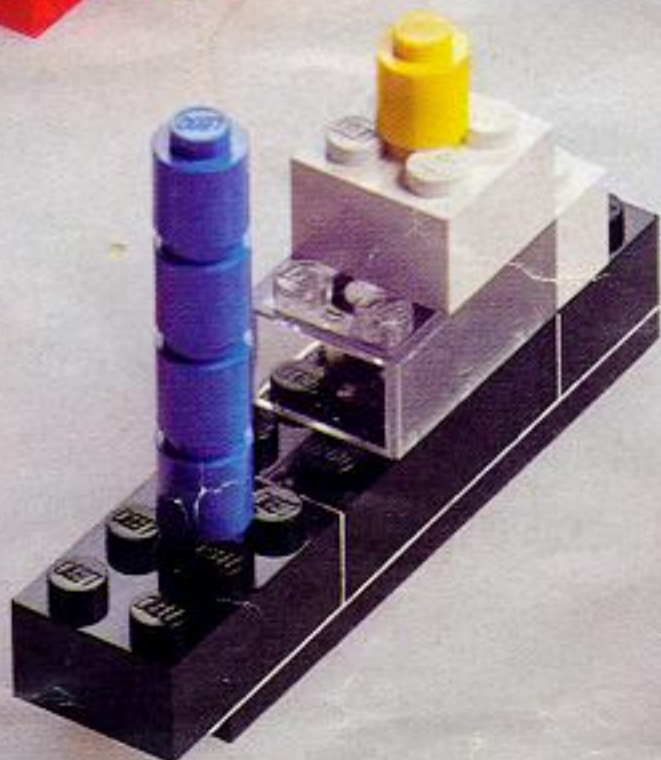
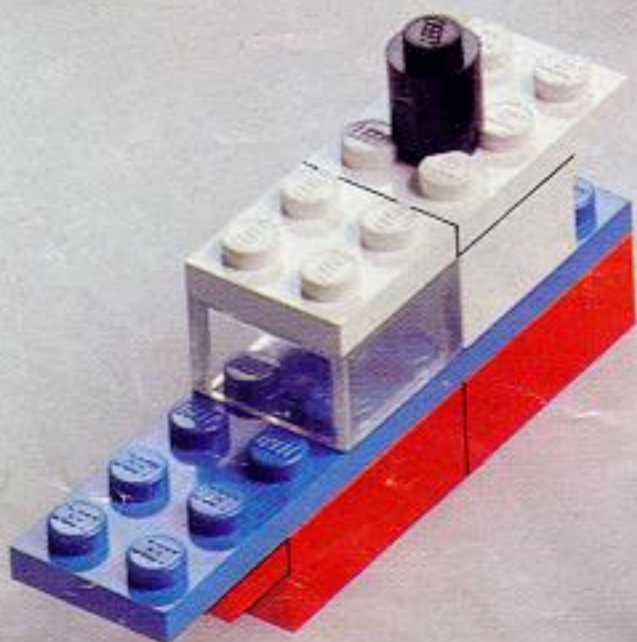
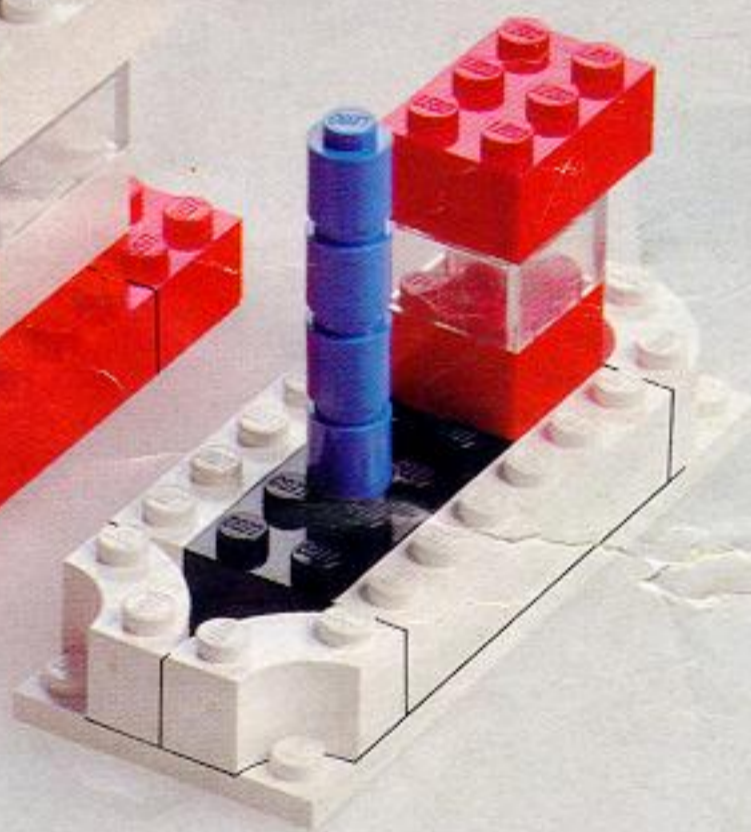
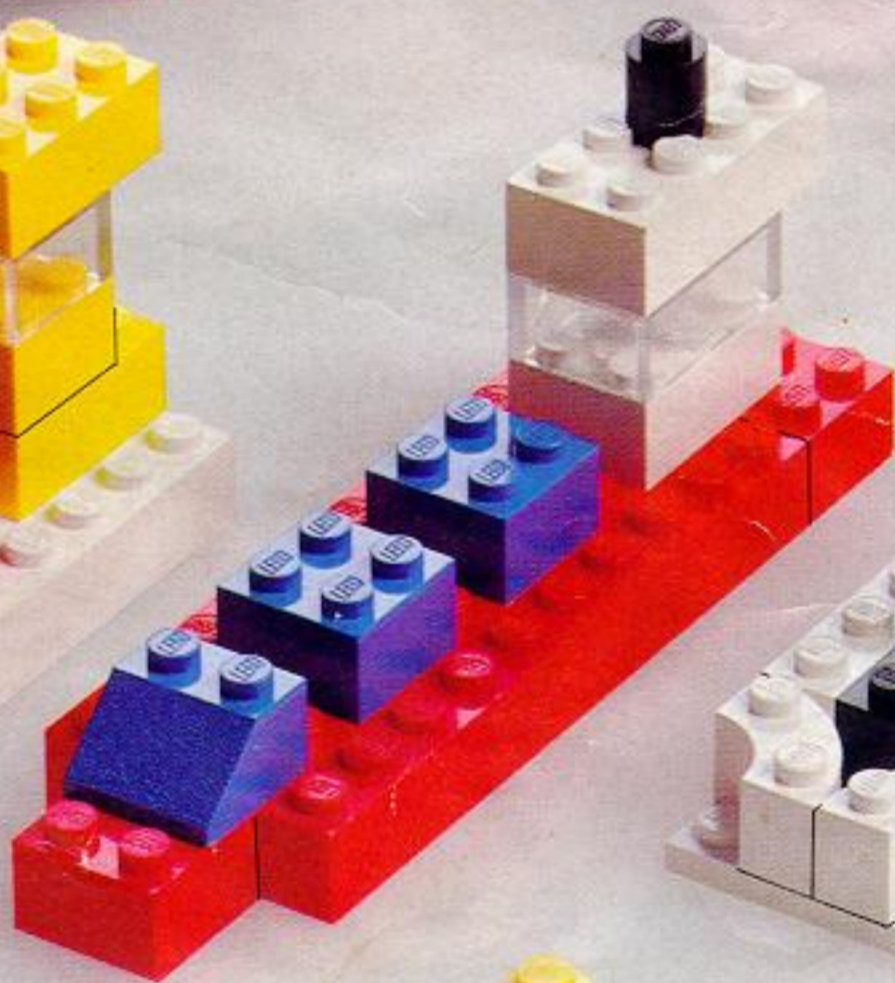
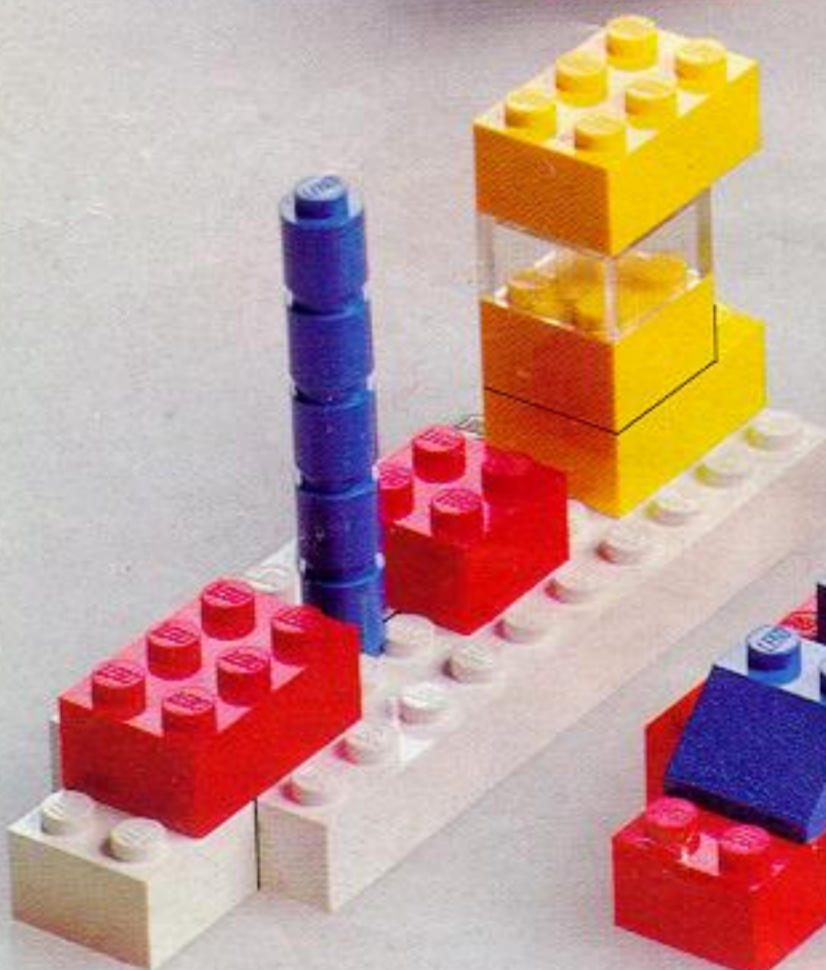
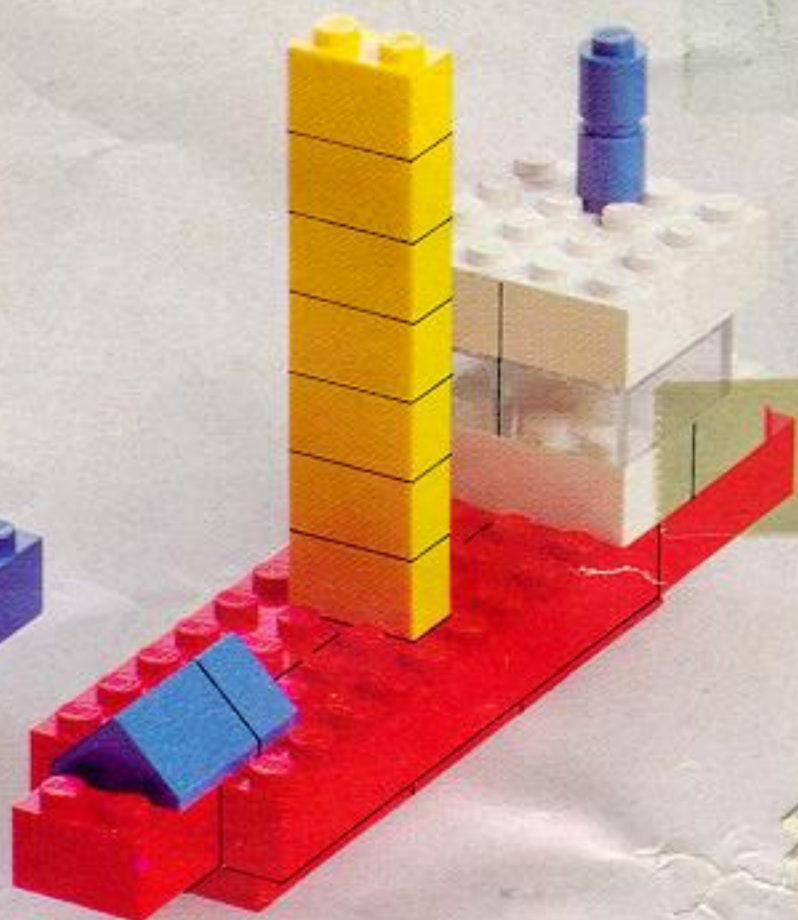
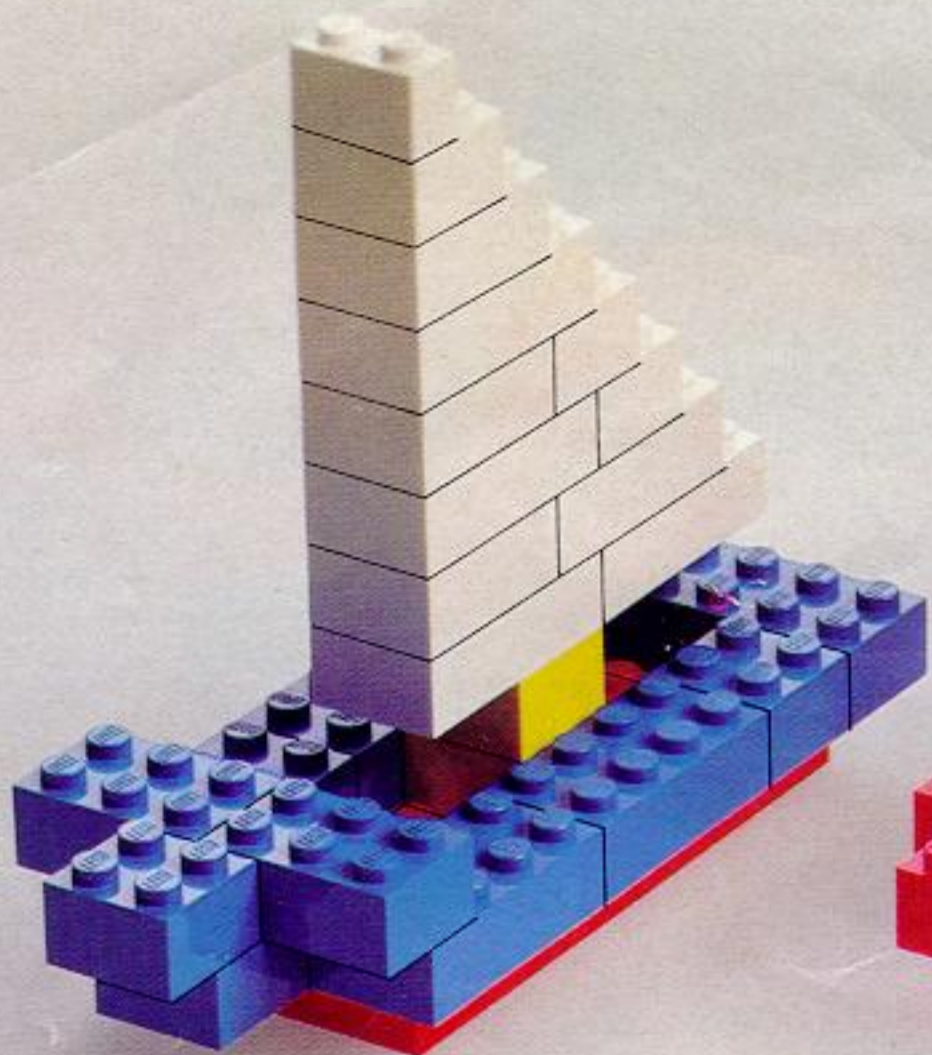

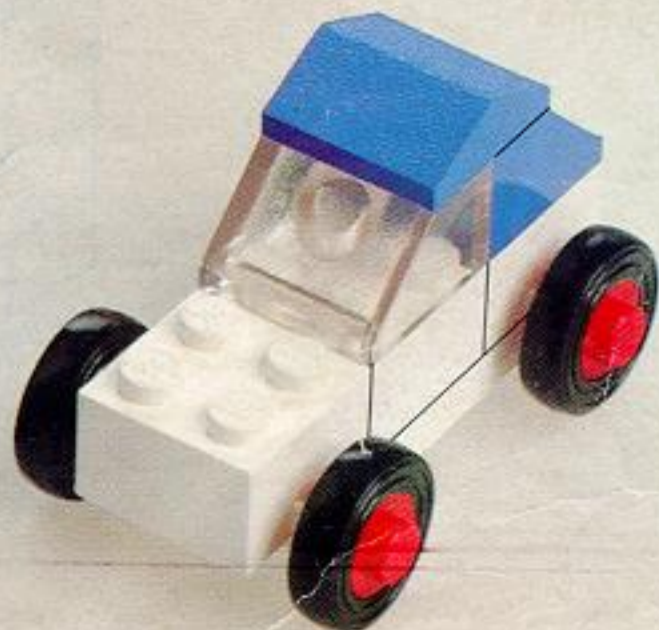
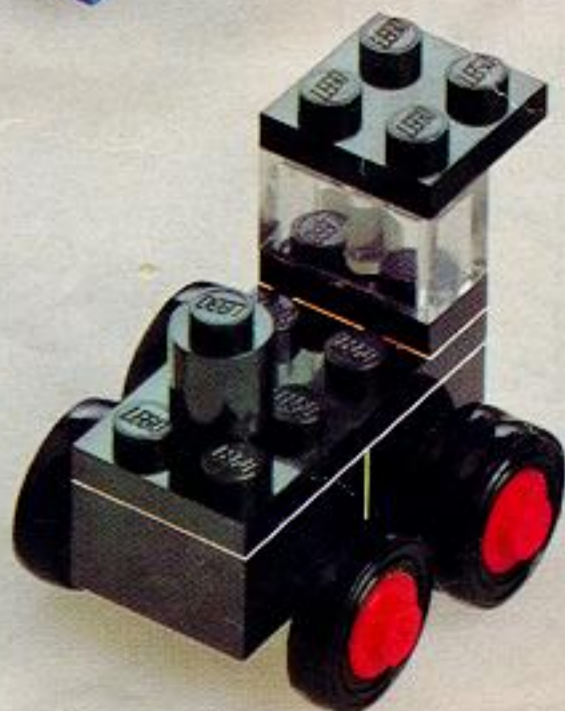
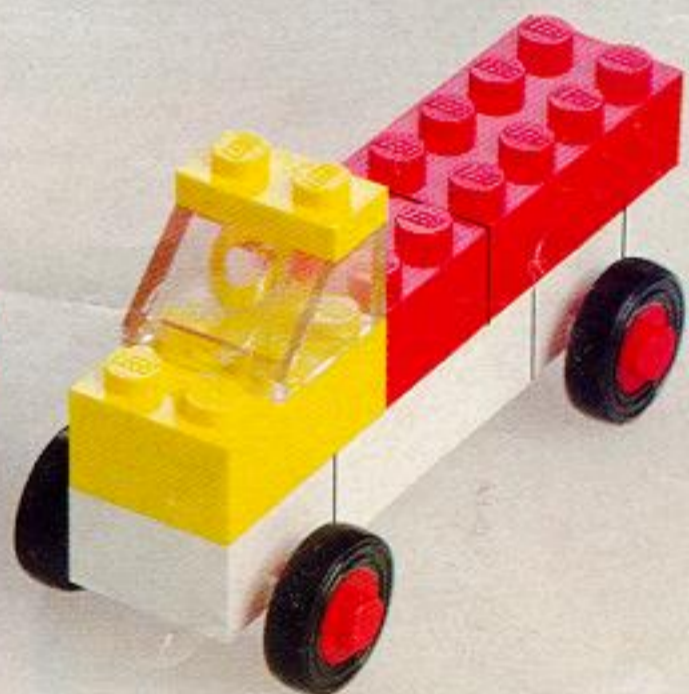
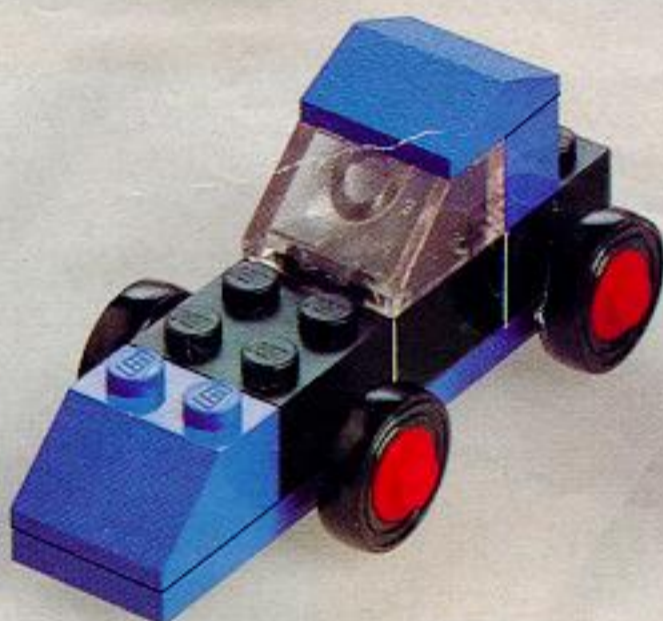
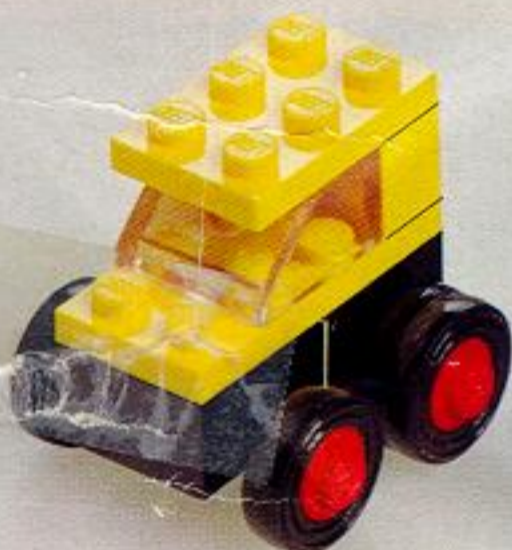
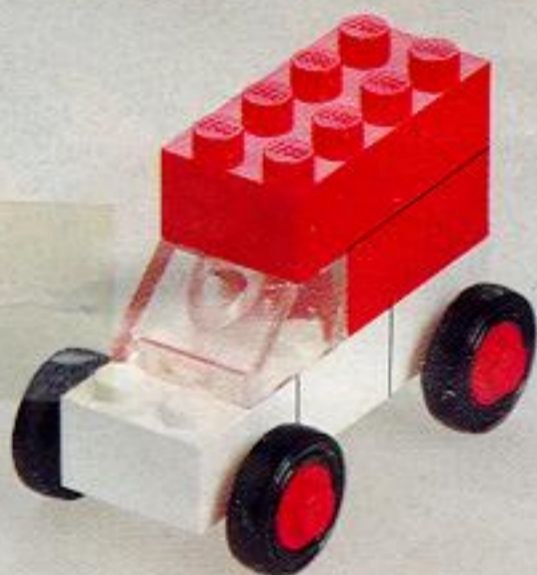
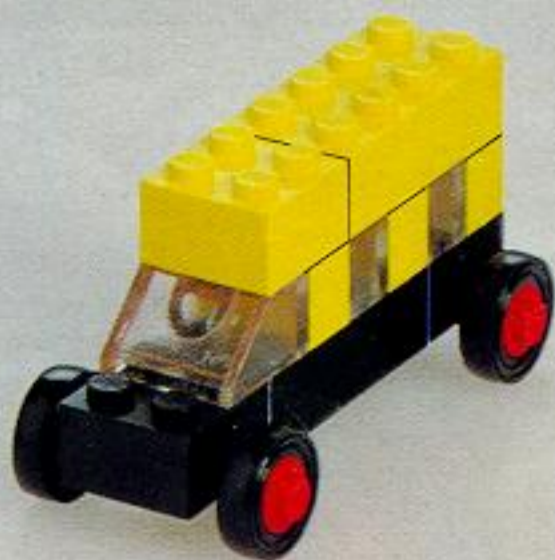
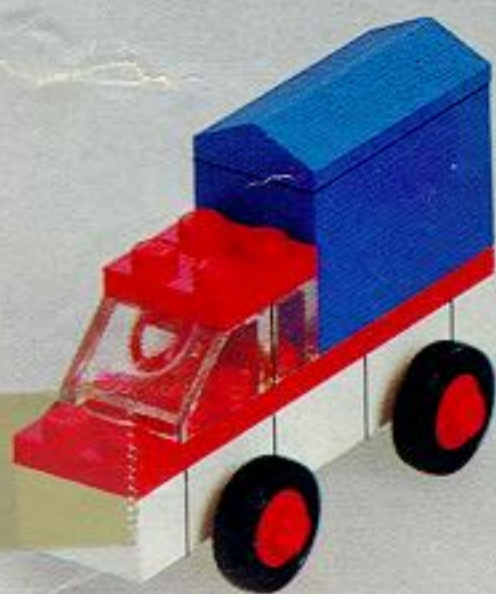

4

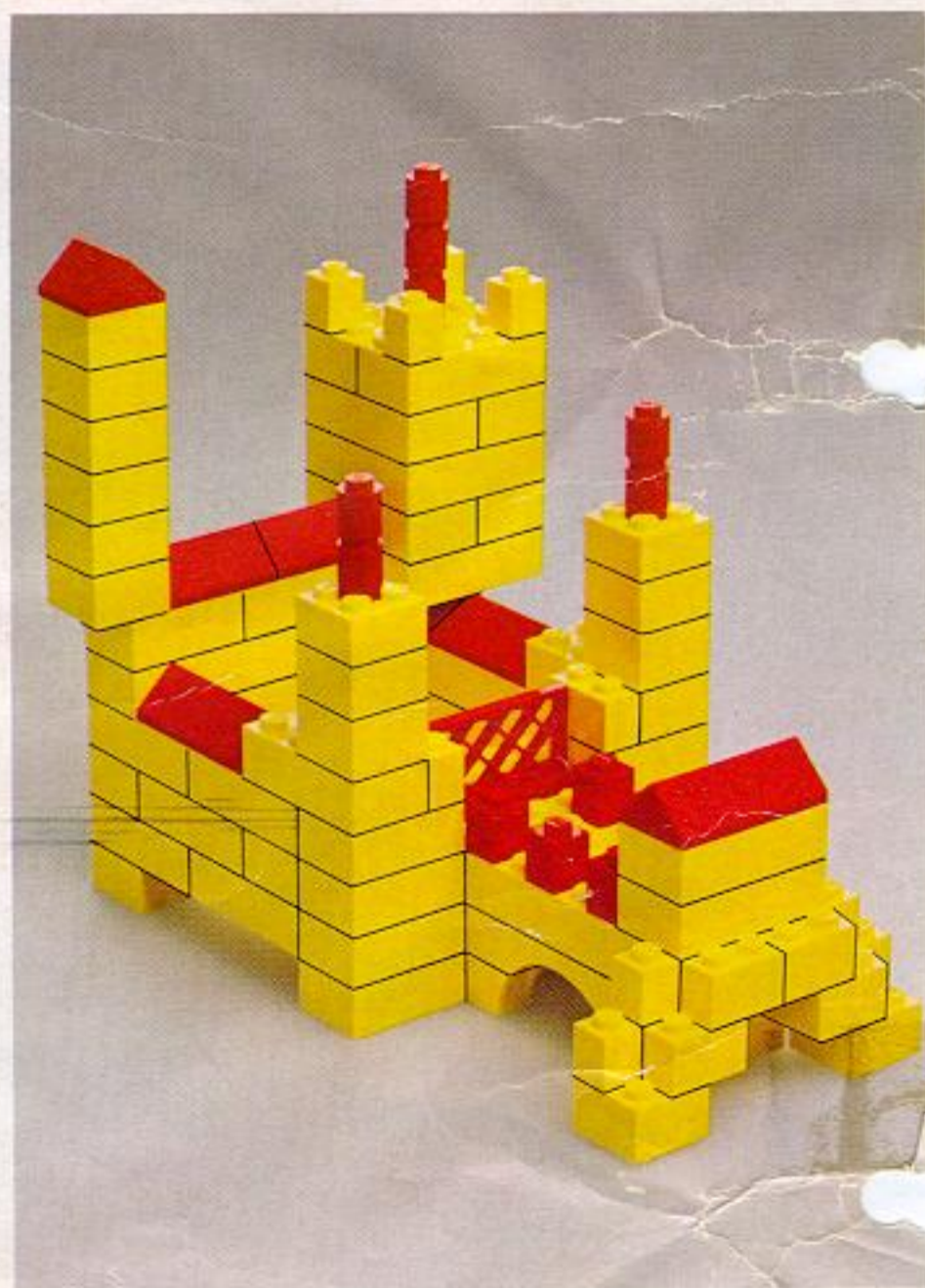
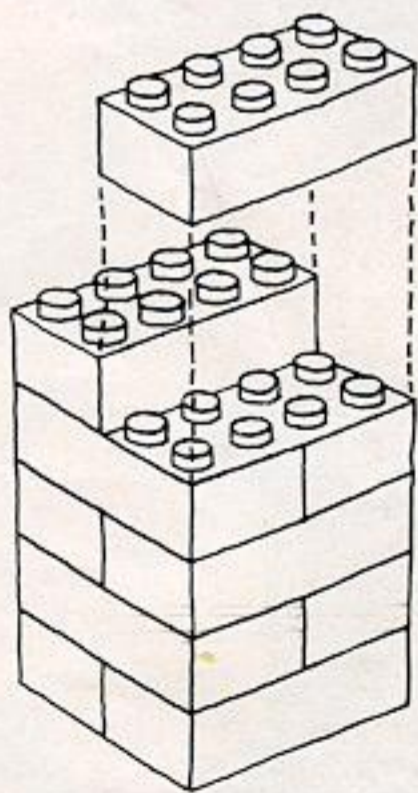
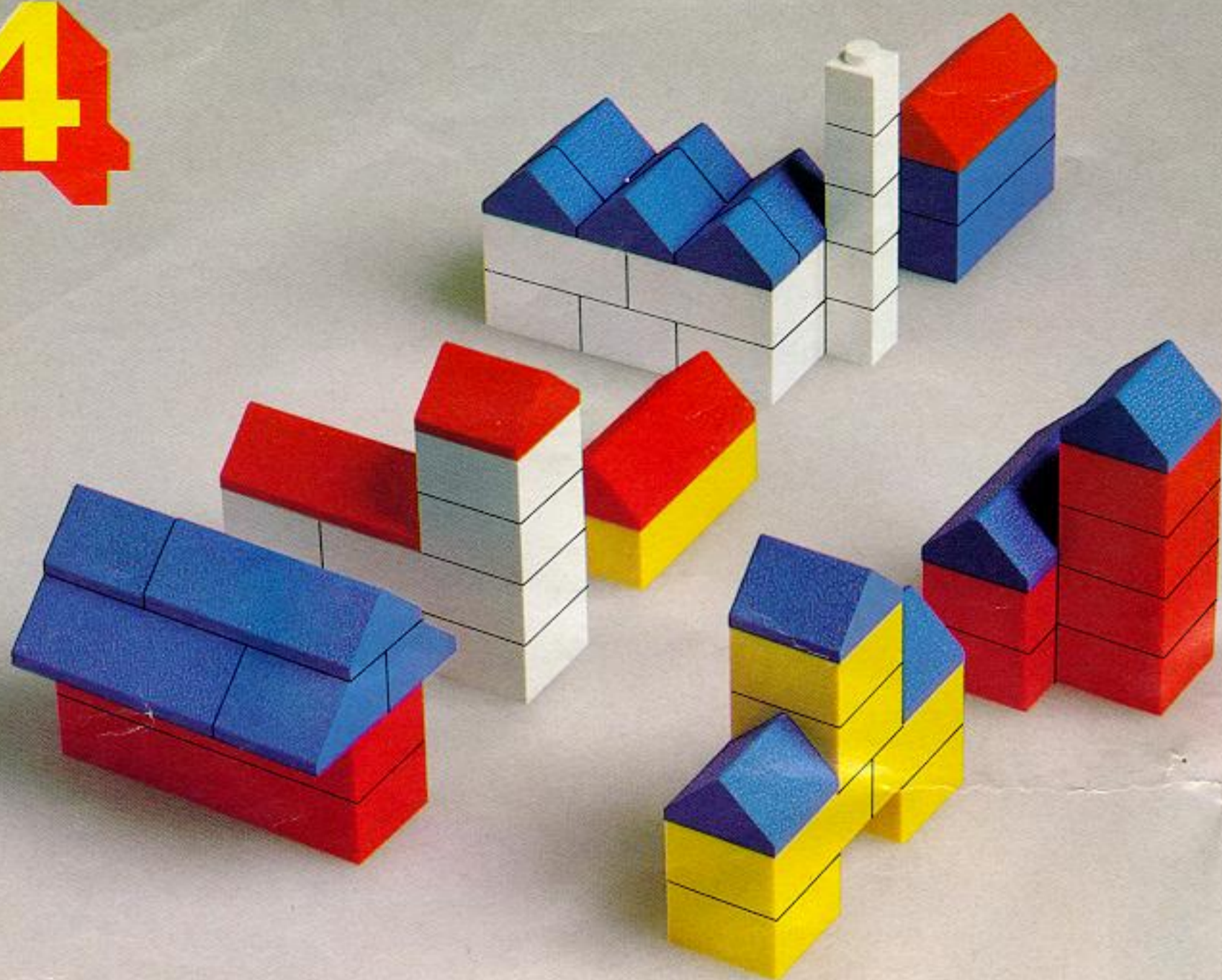

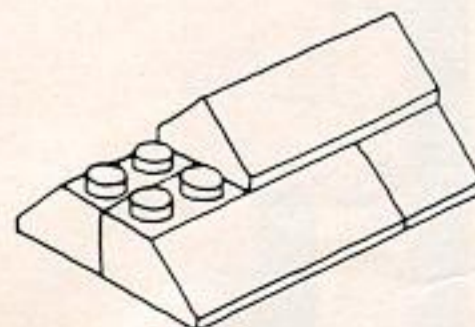
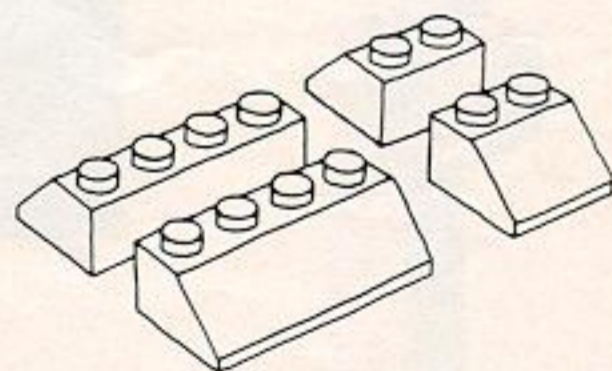
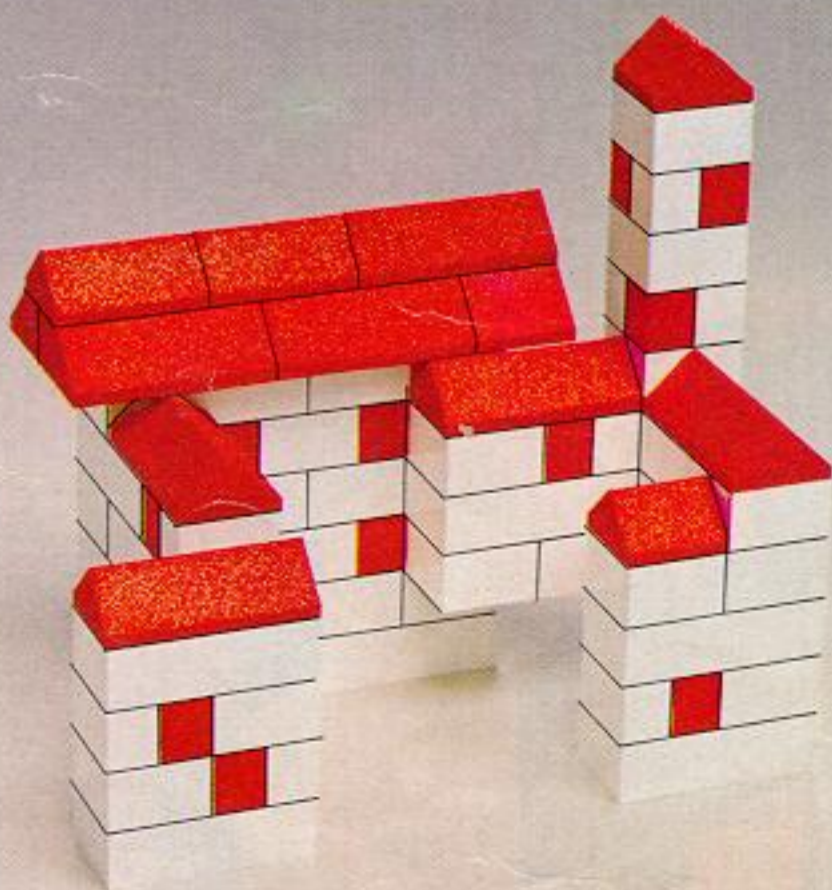
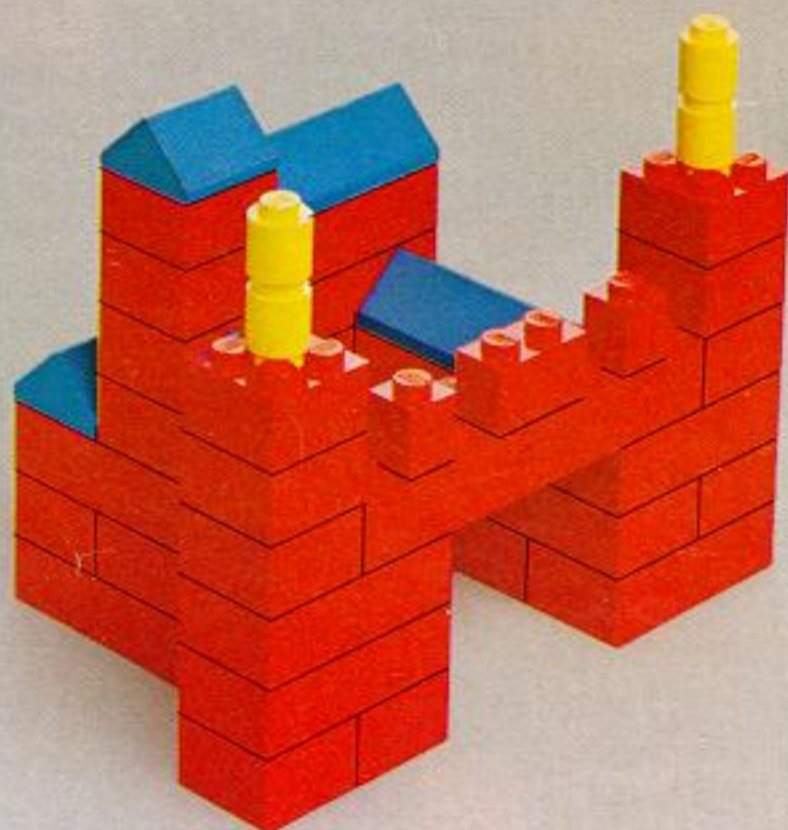
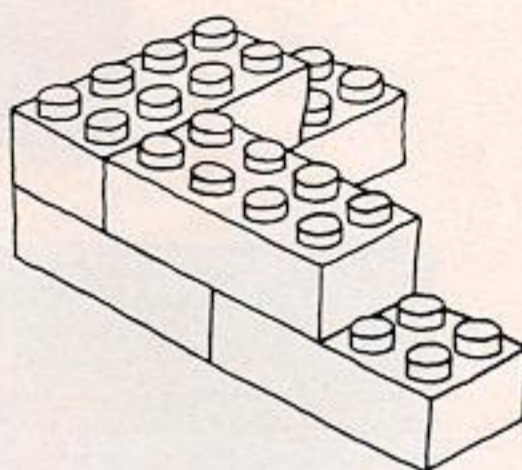
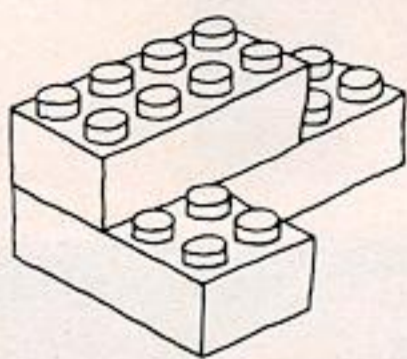
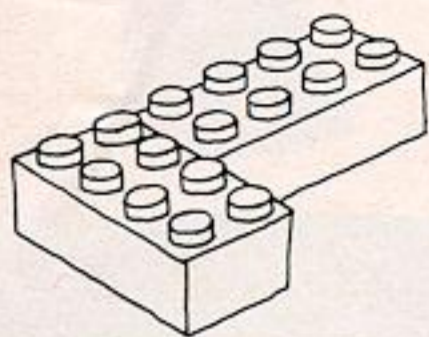

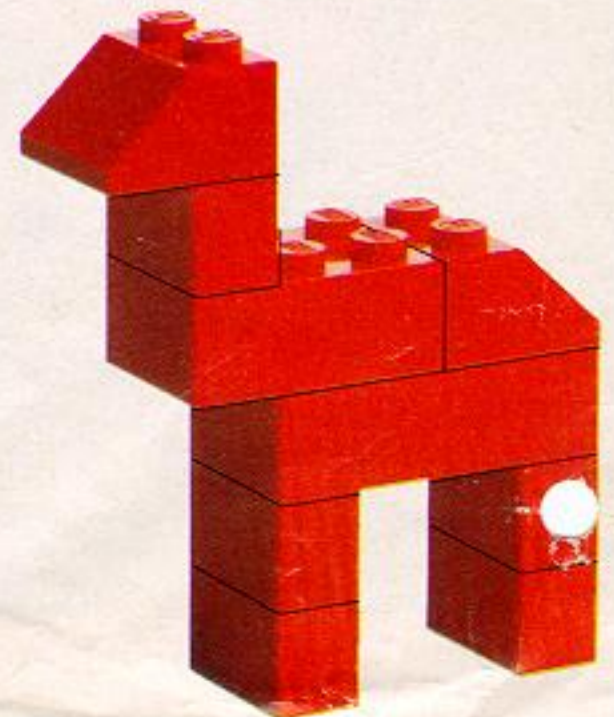
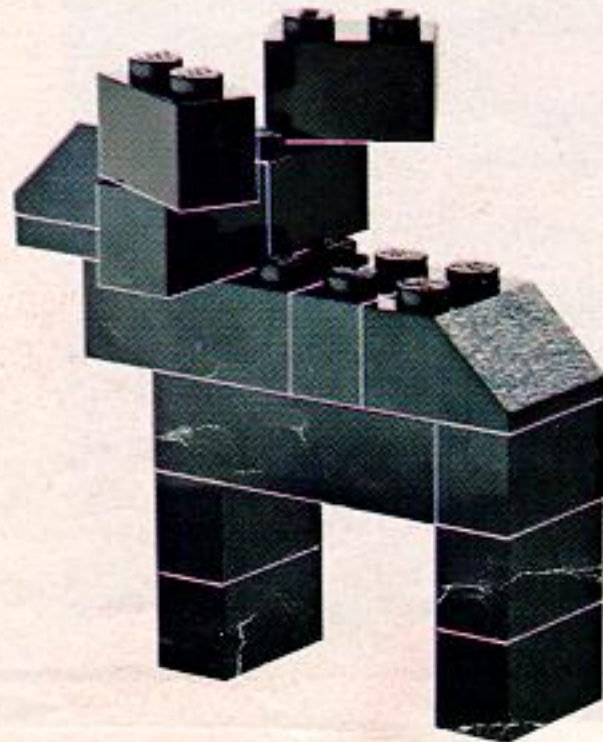
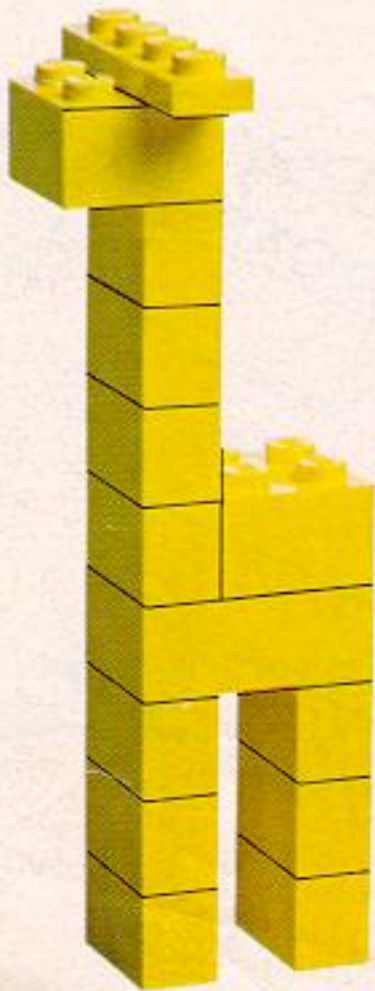
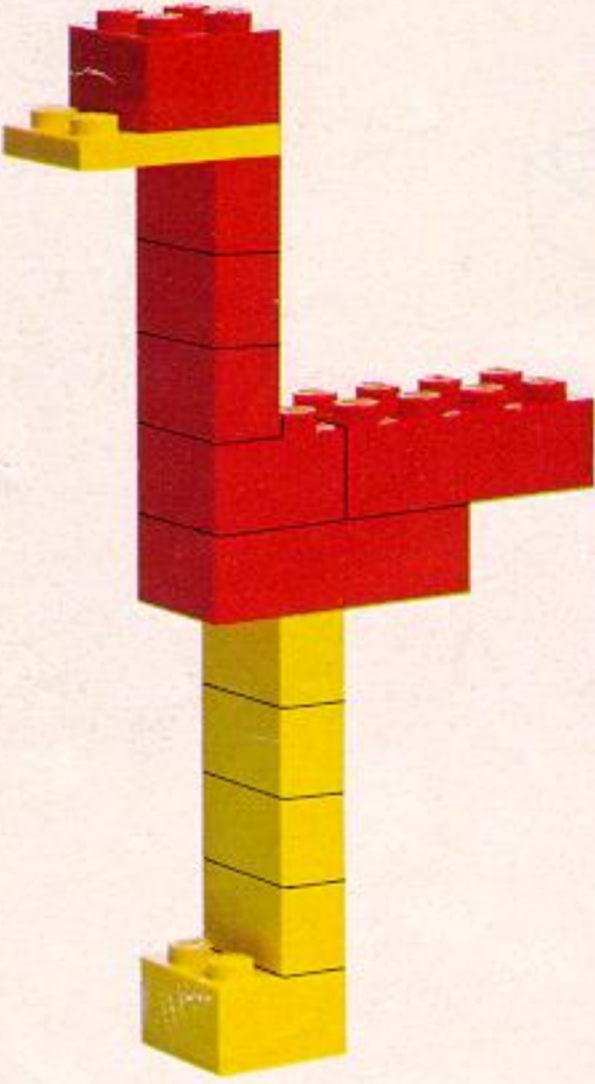
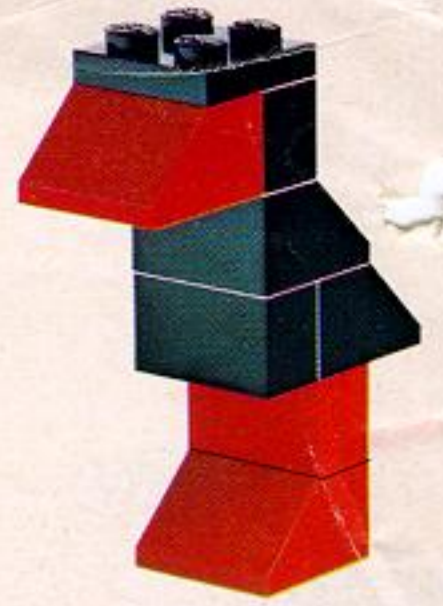
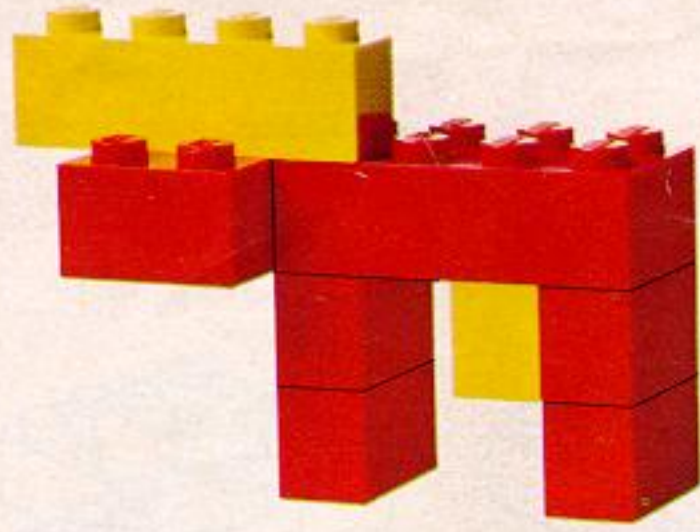

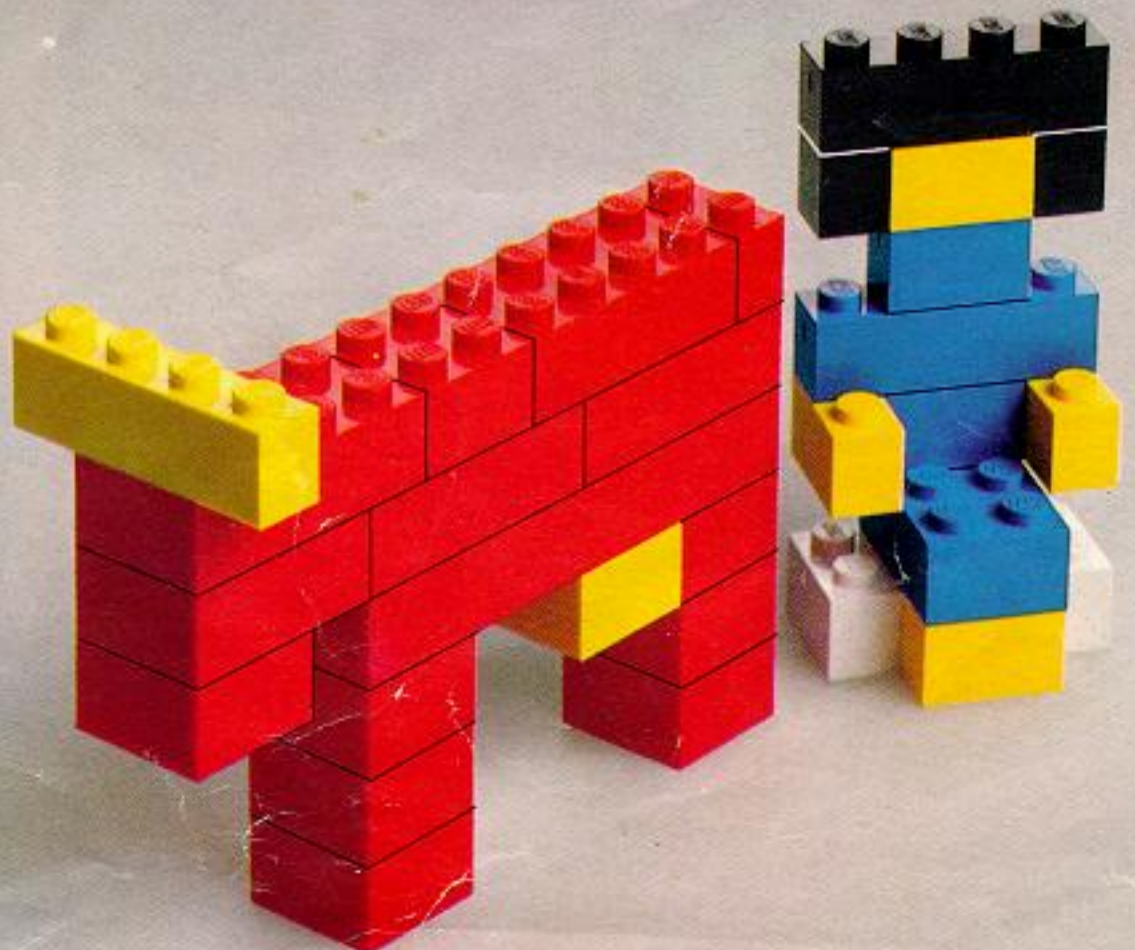
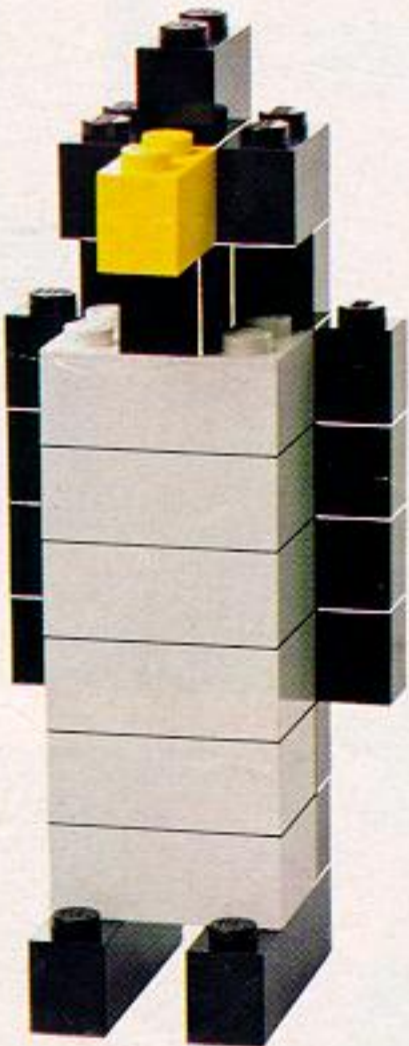
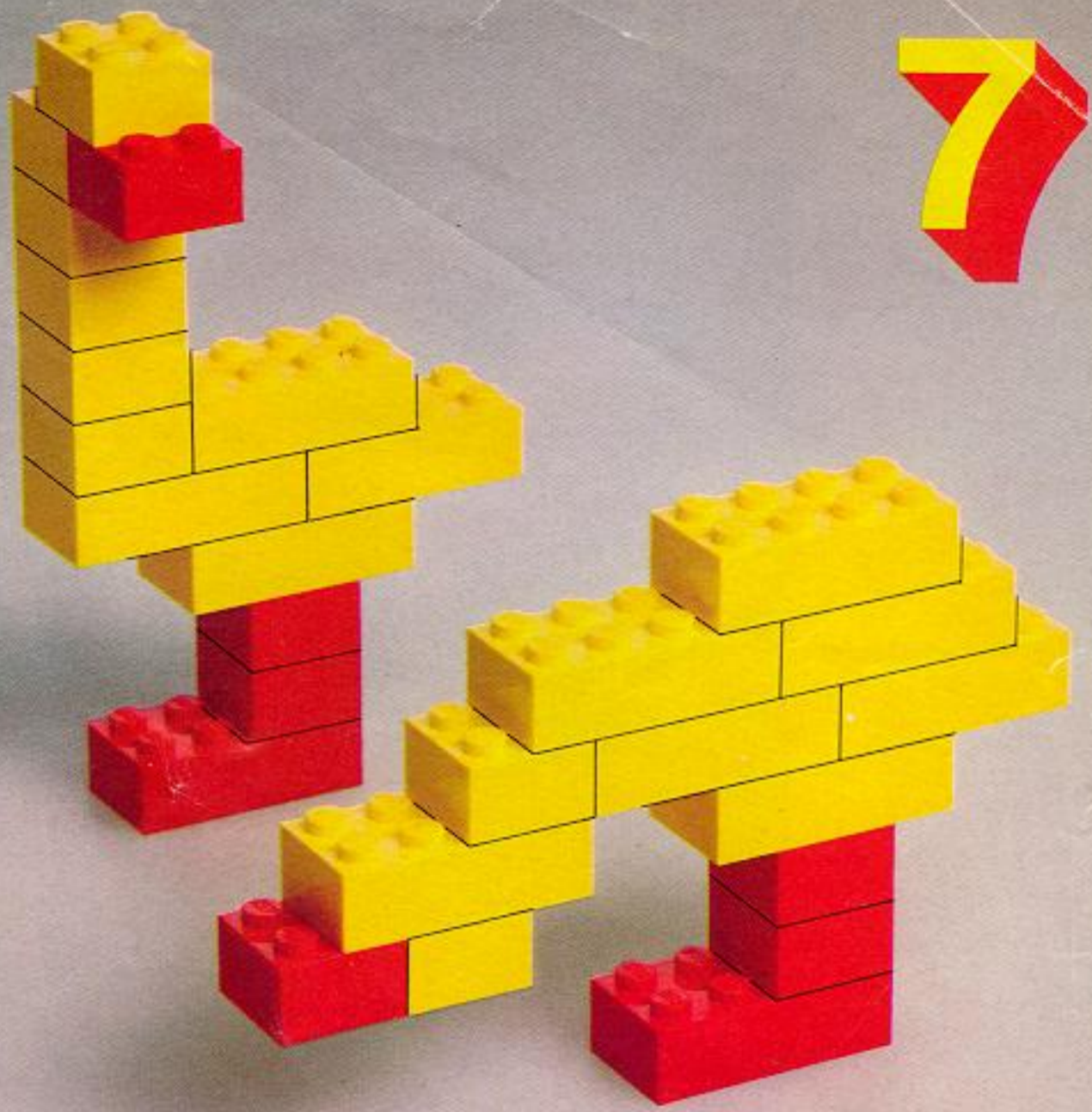
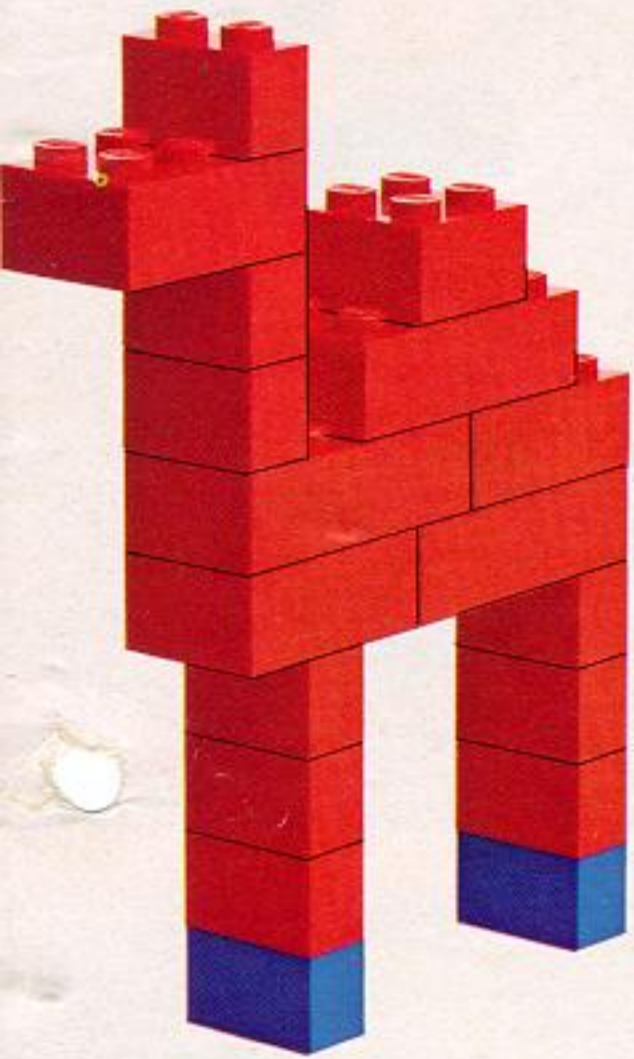

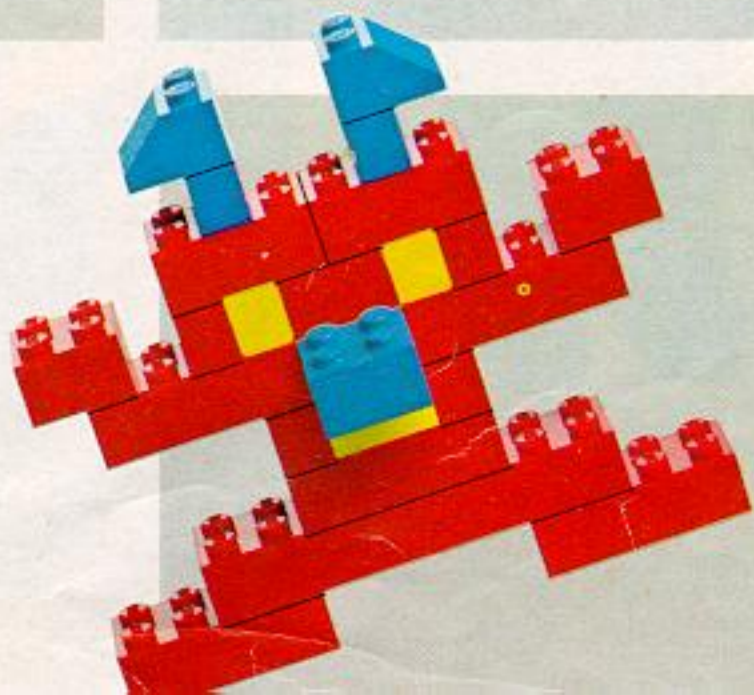
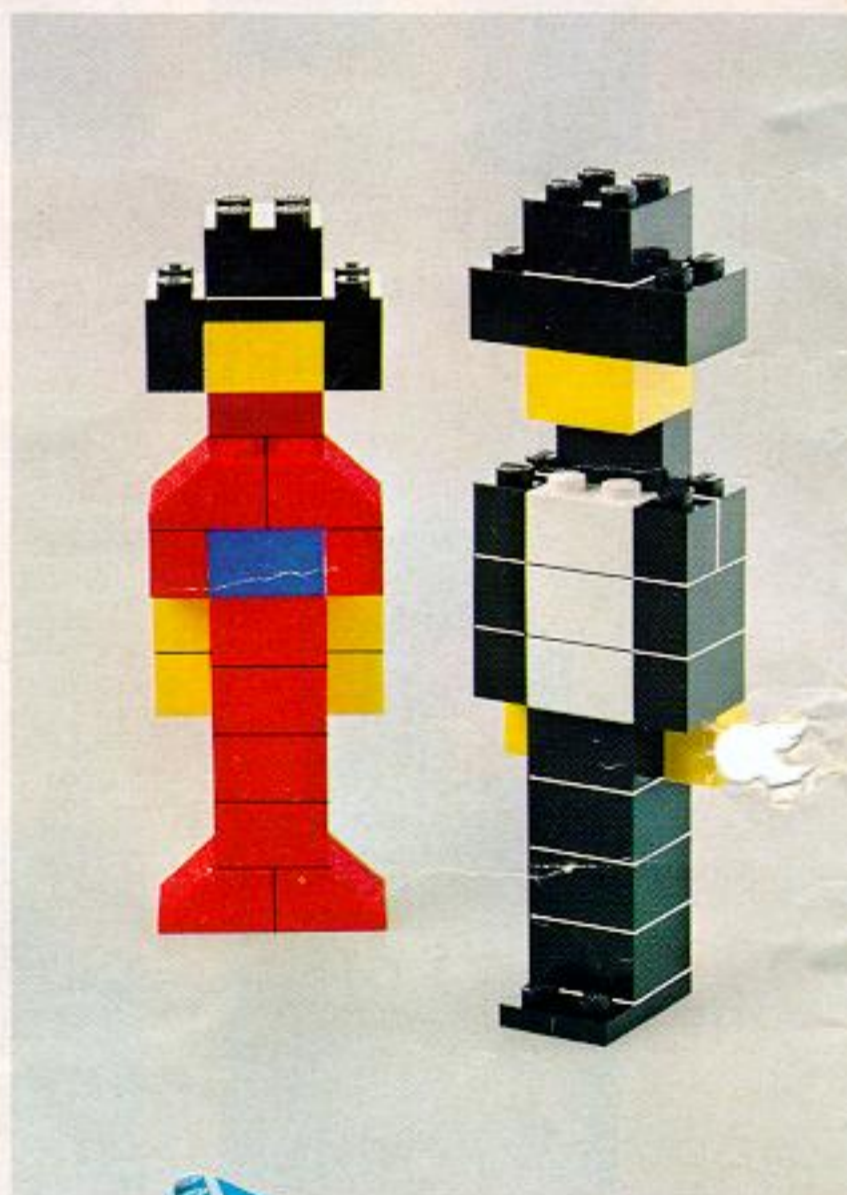
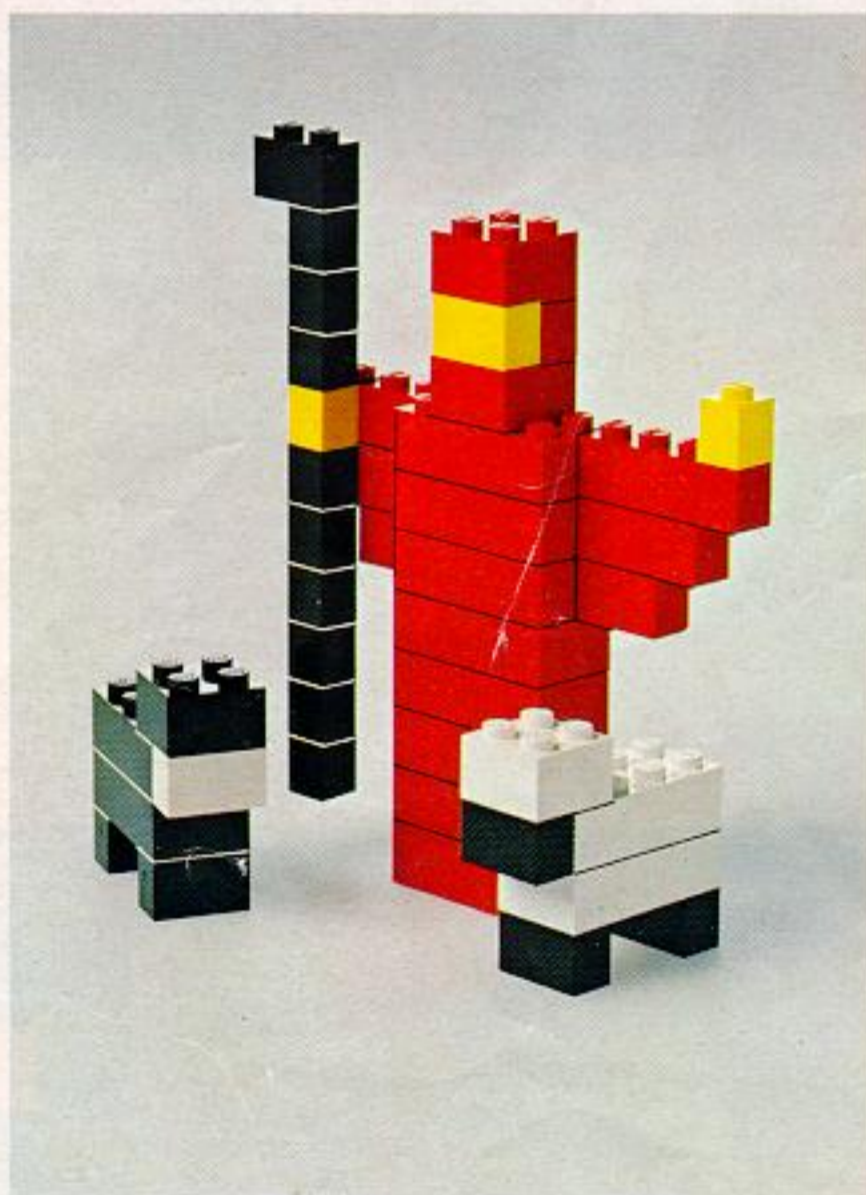
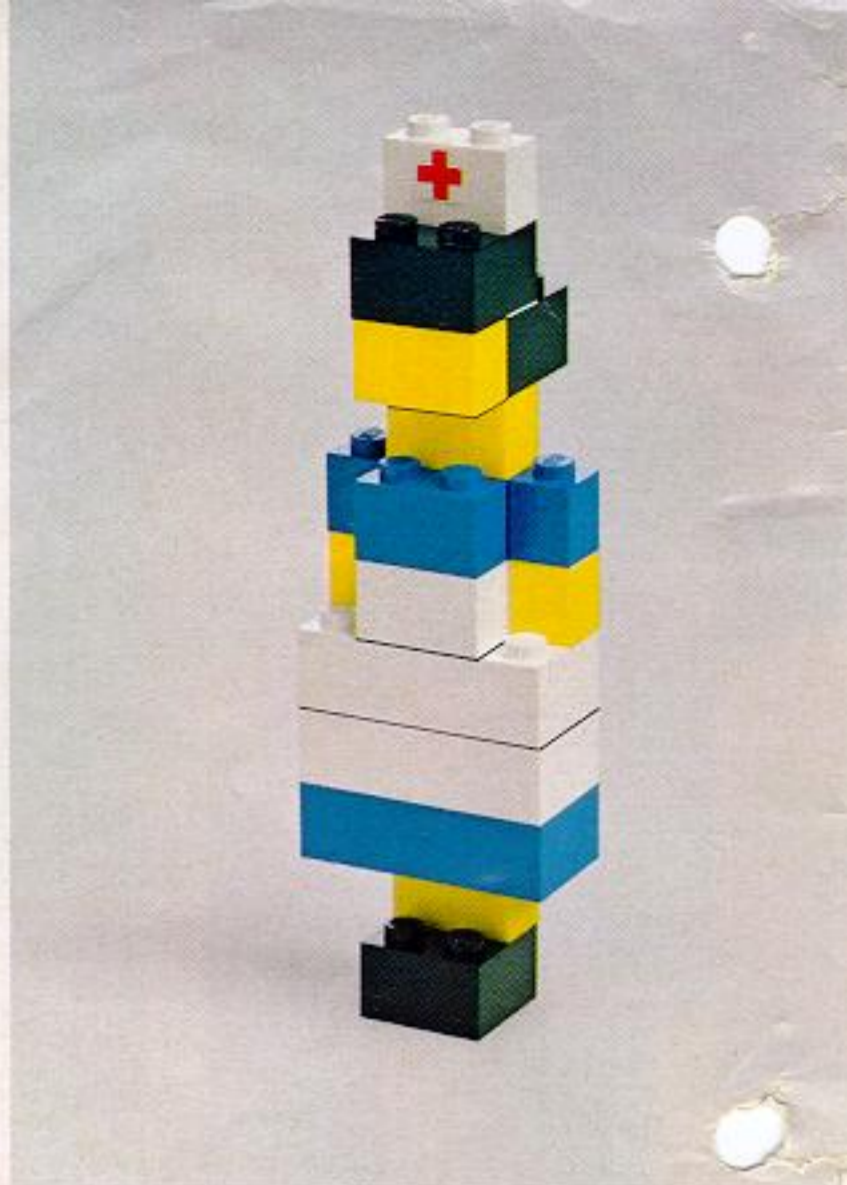
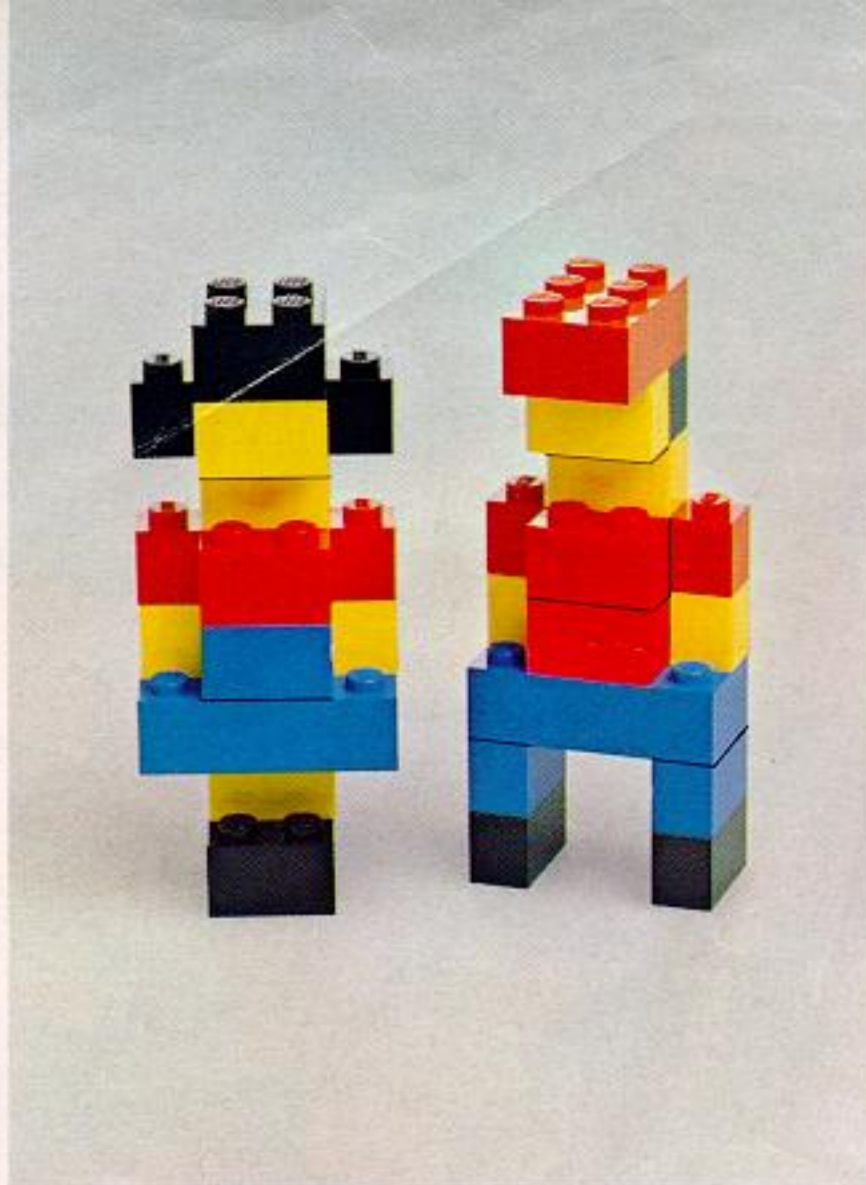

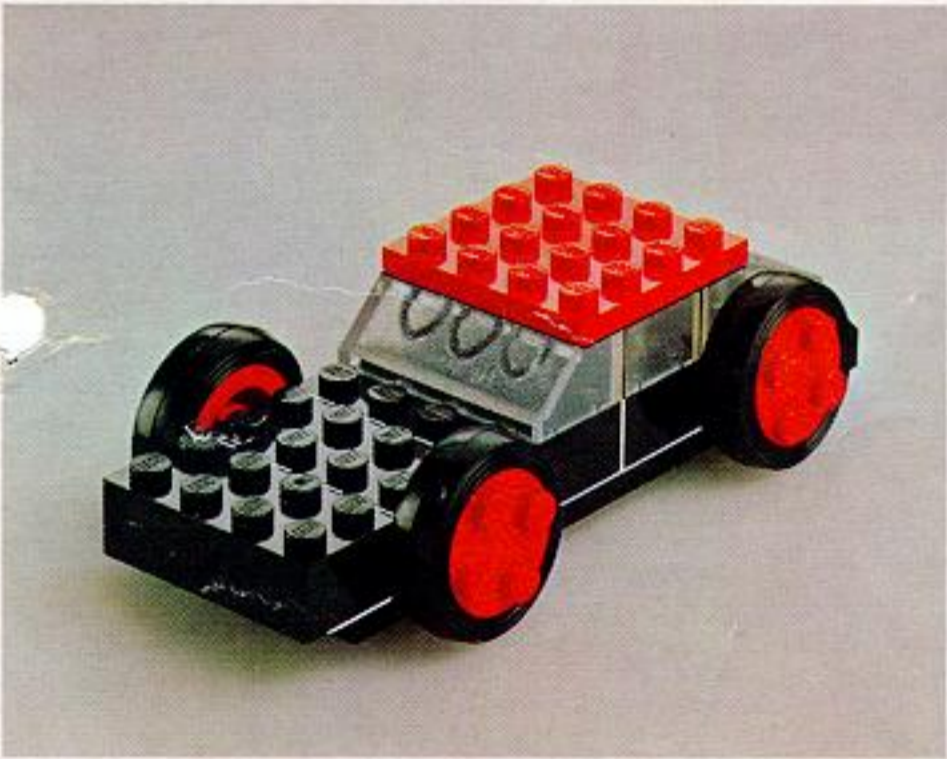
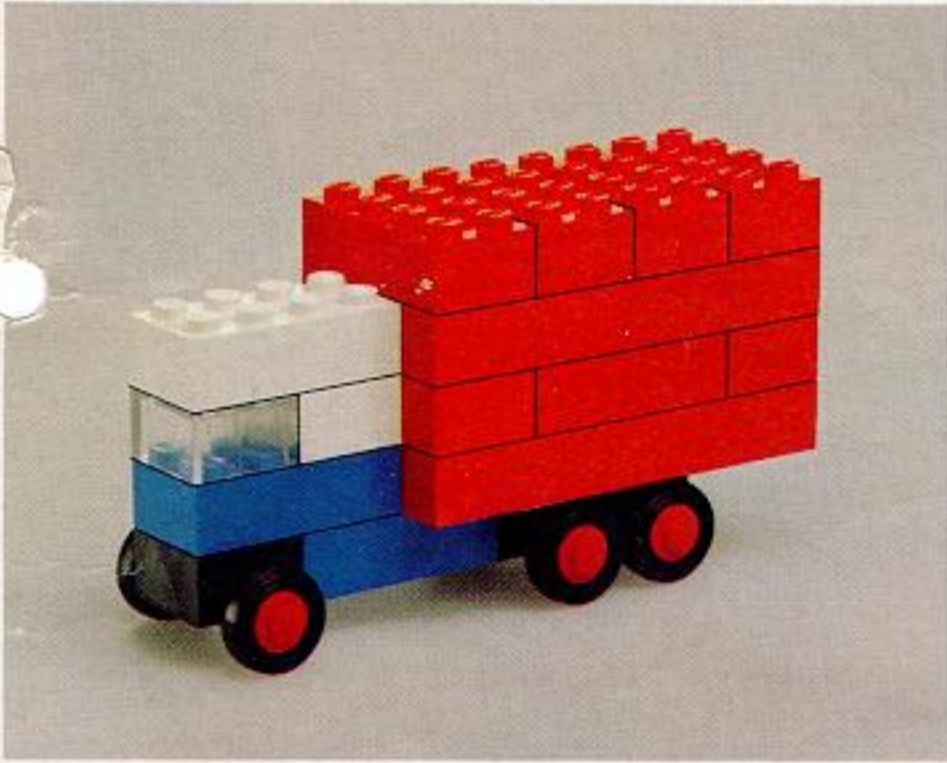

10

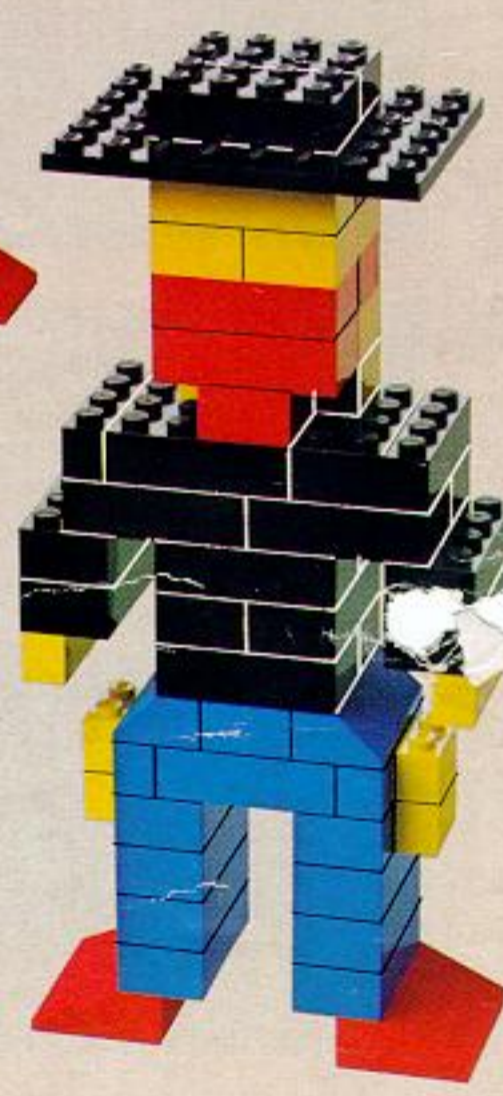
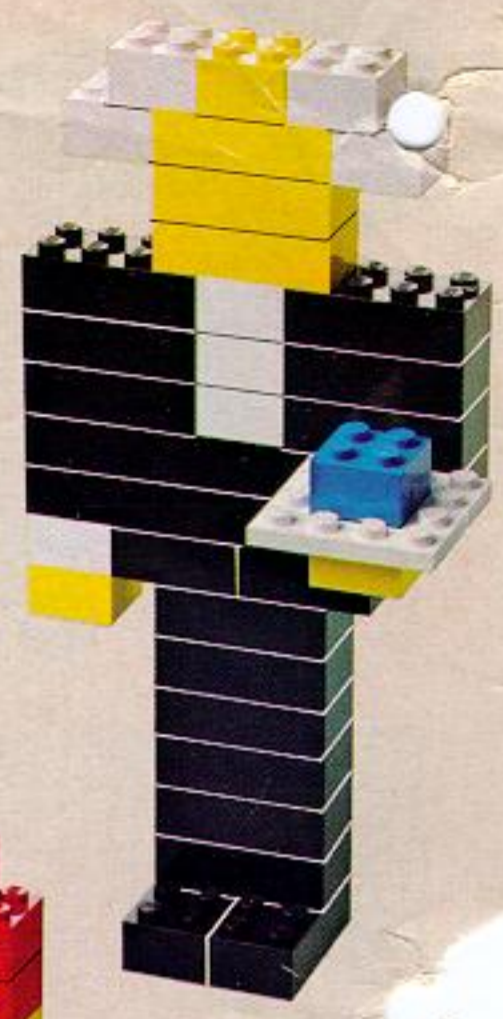
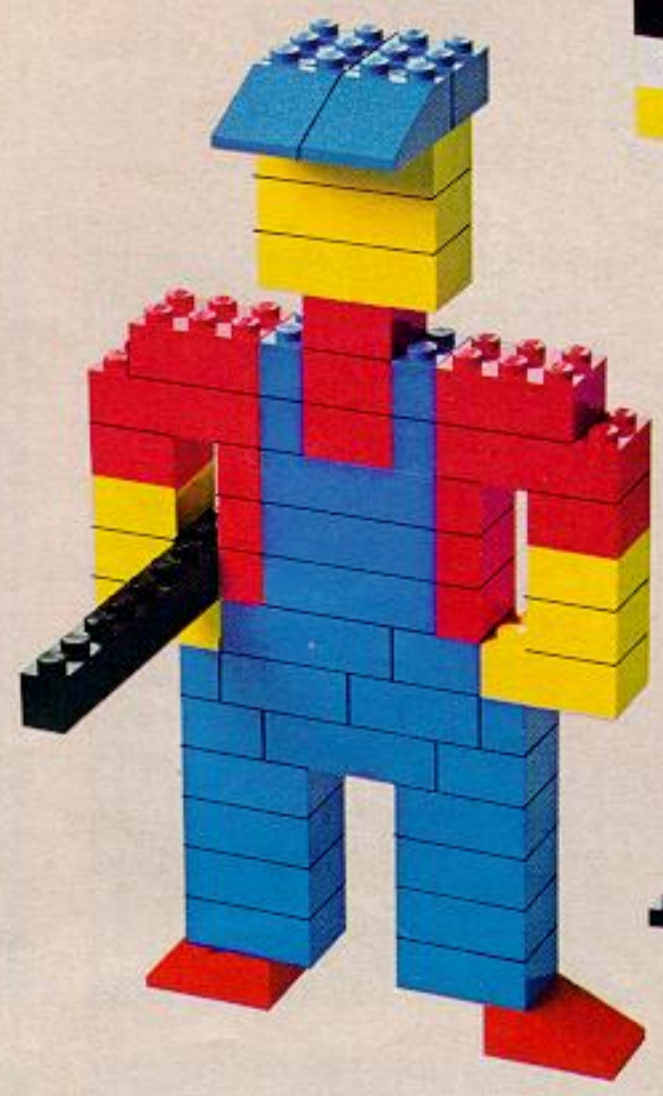
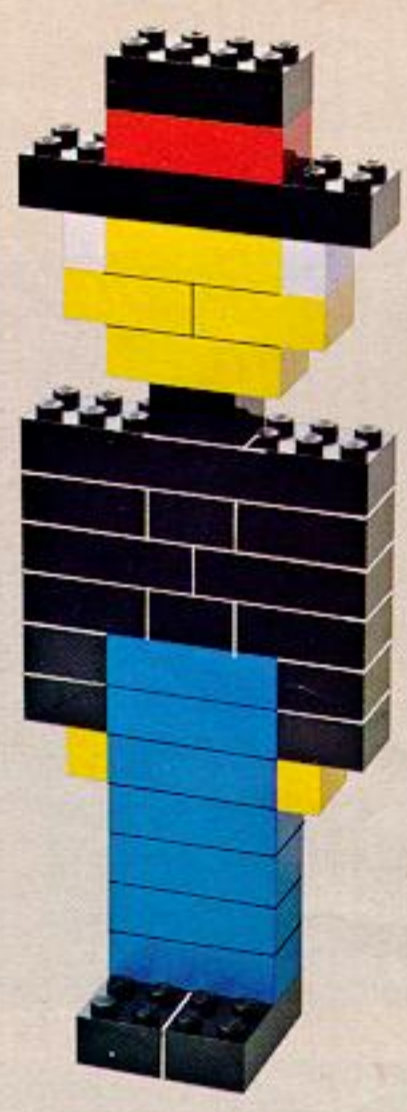
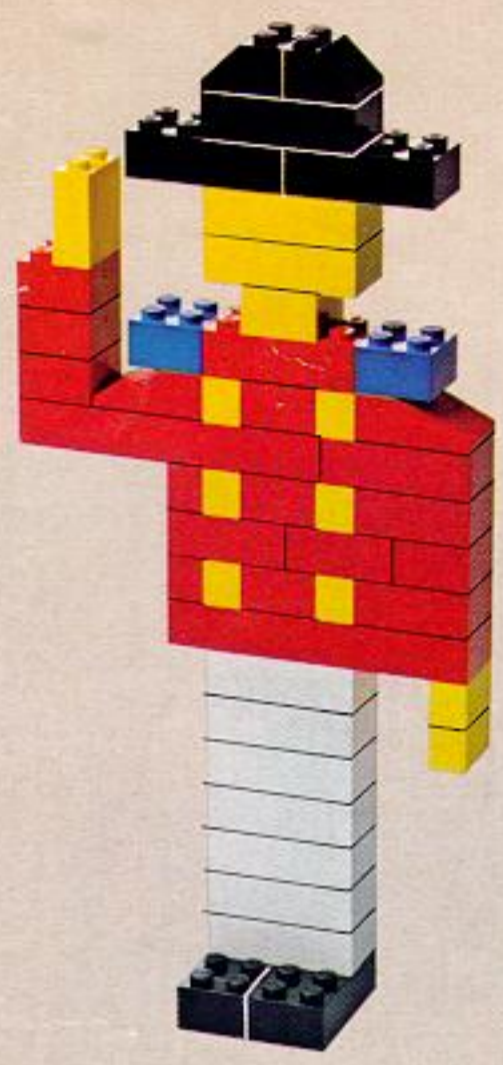

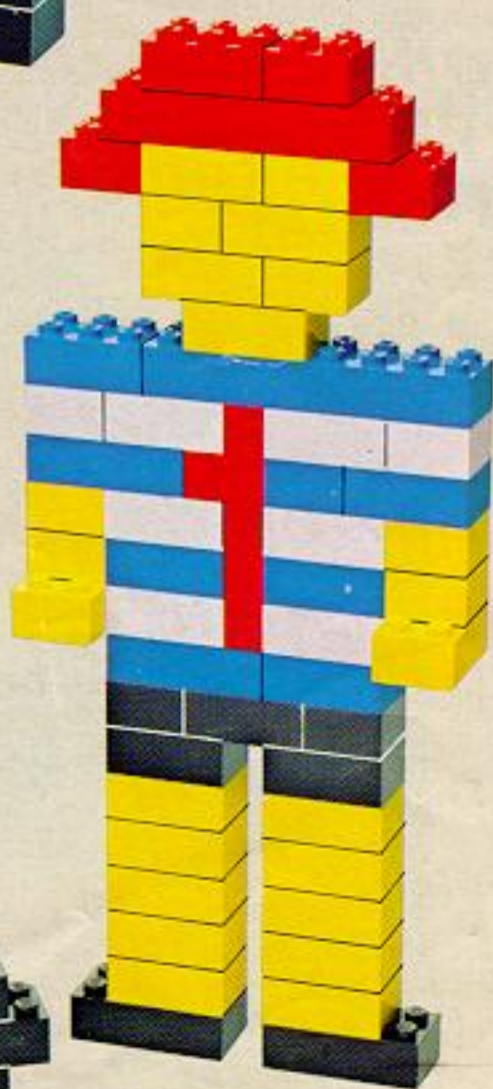
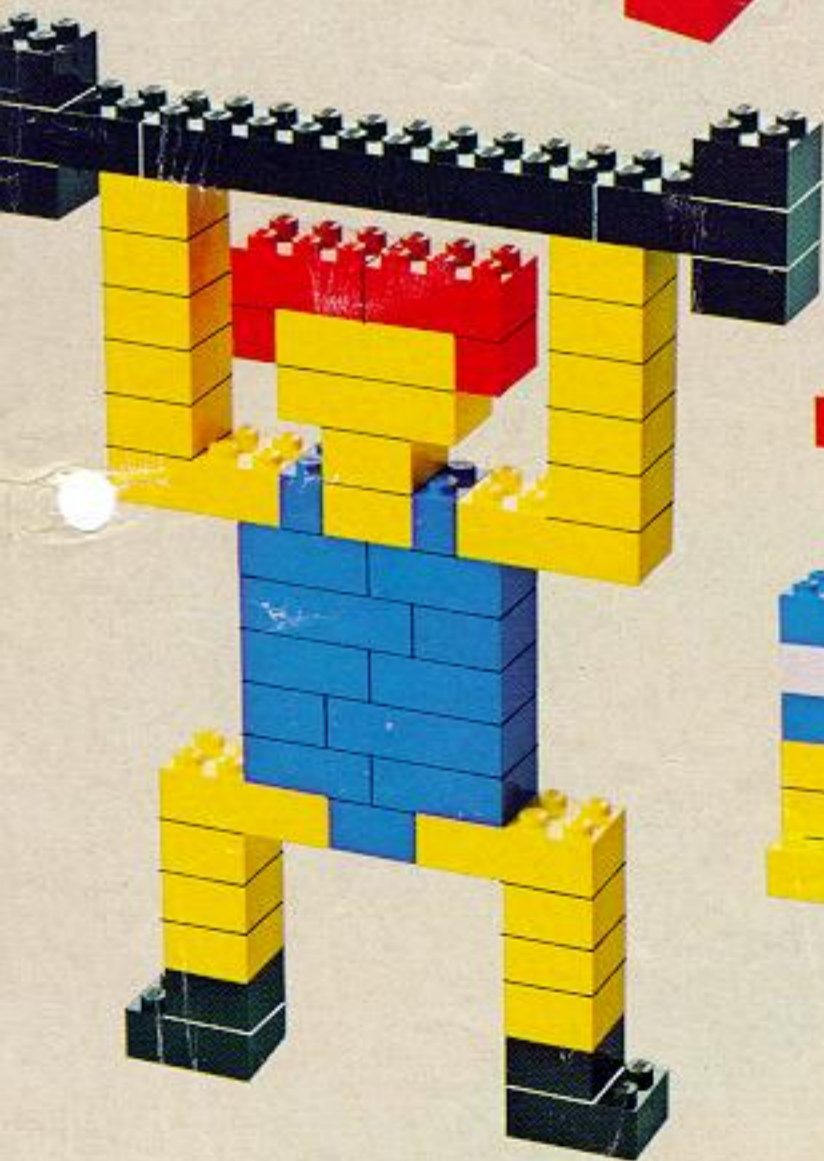
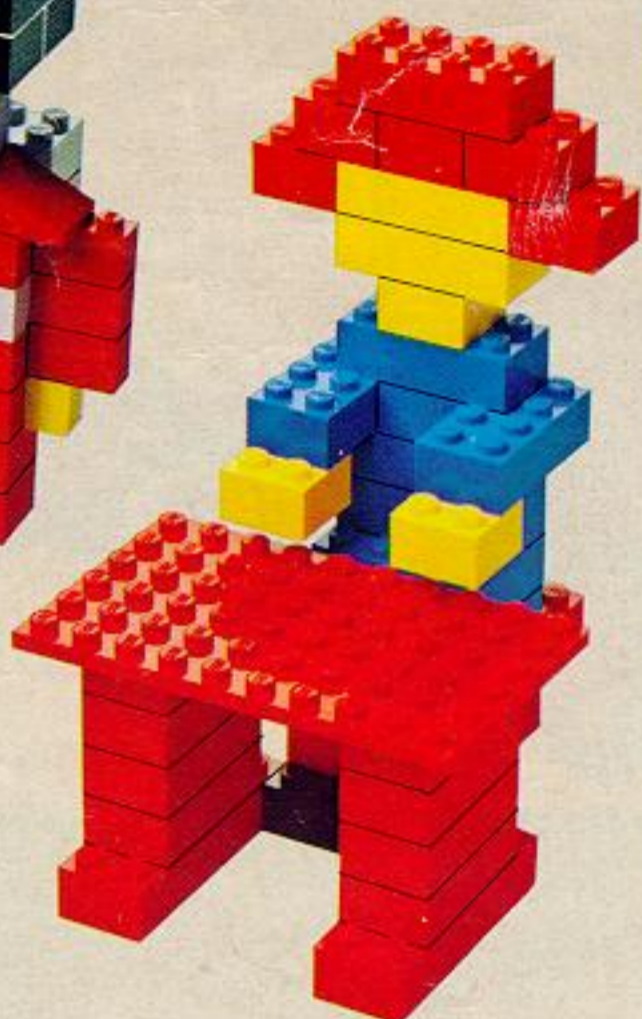
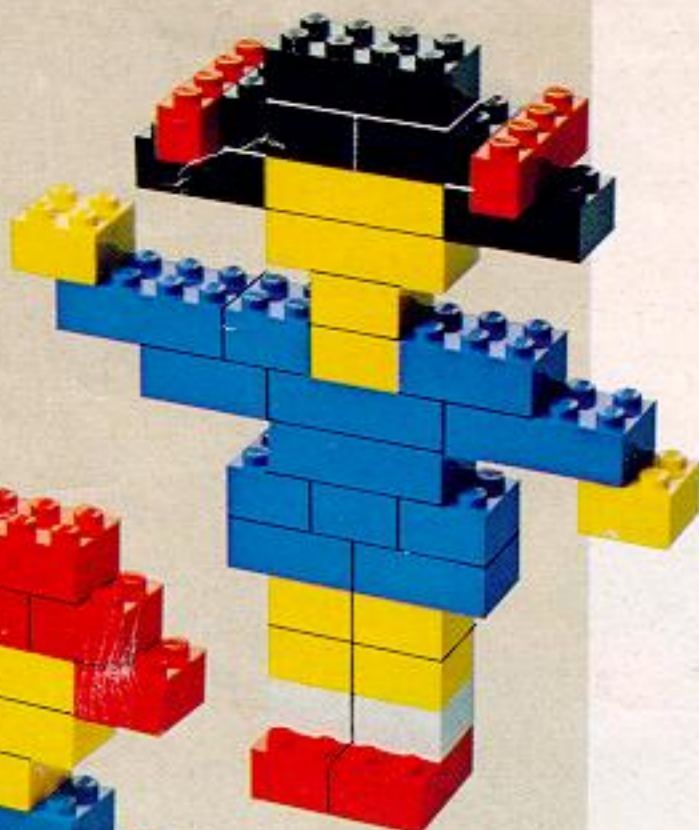

12

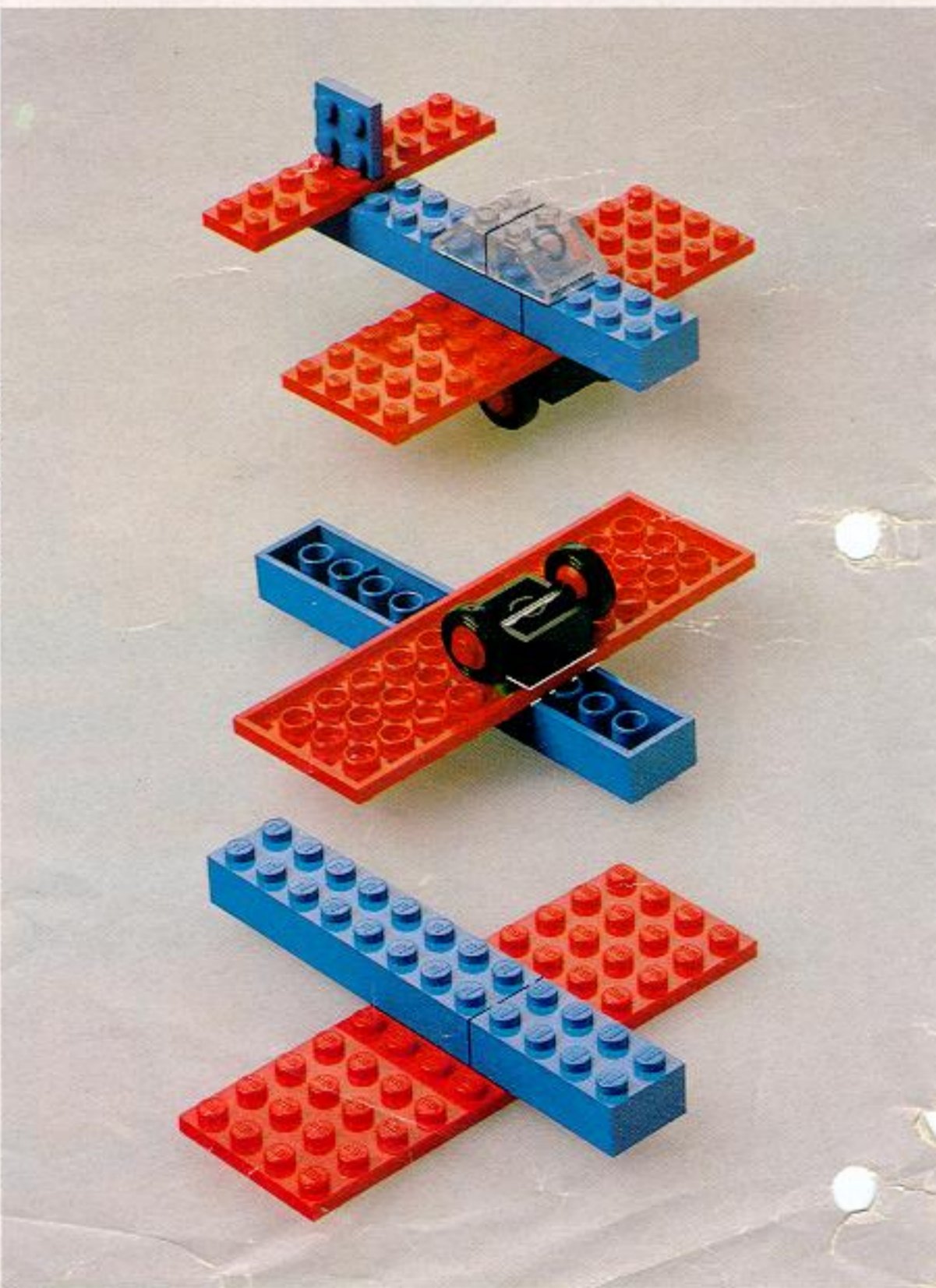
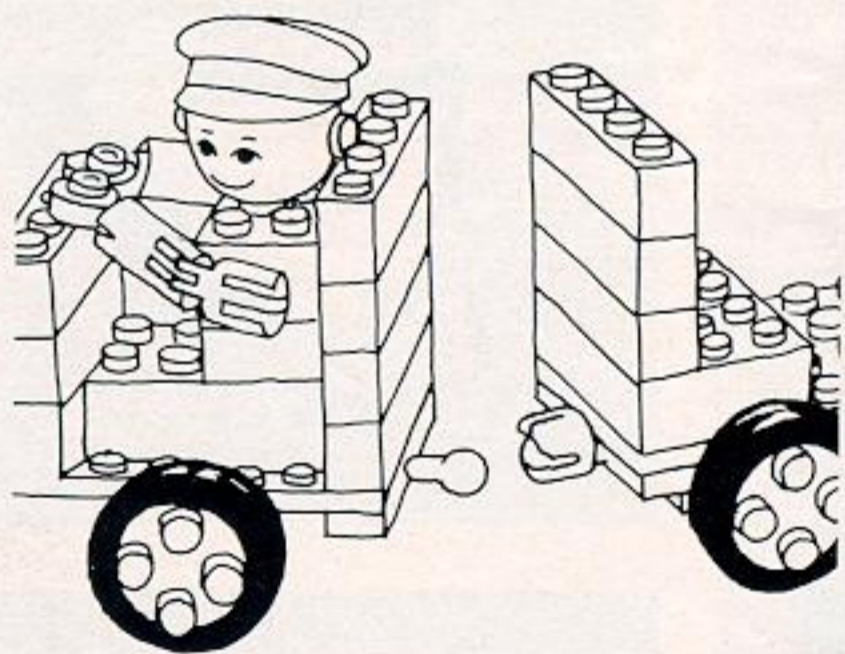

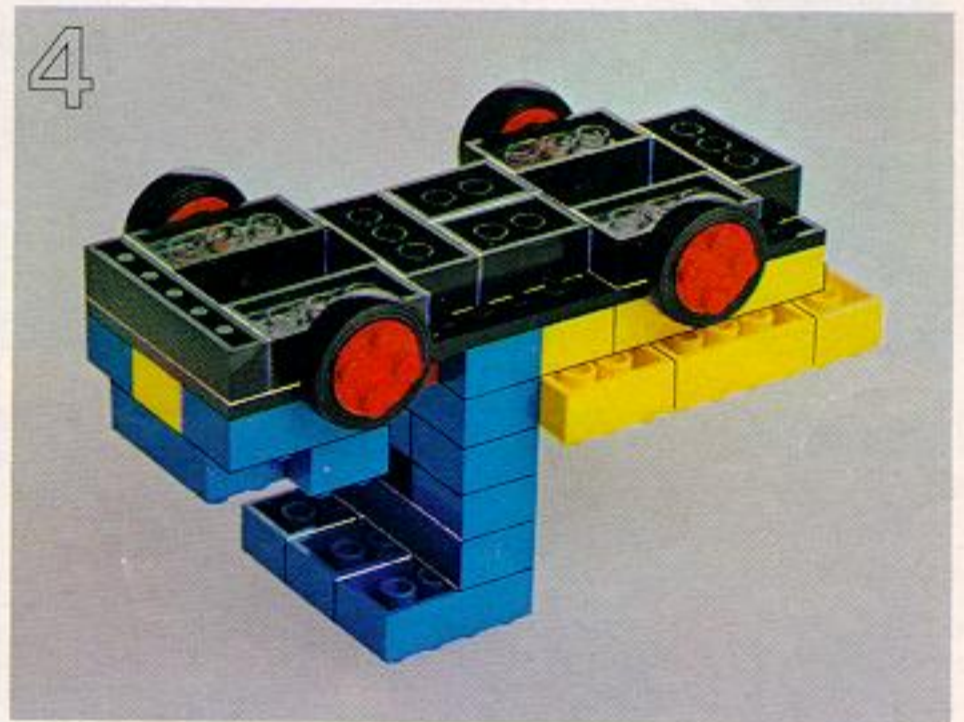
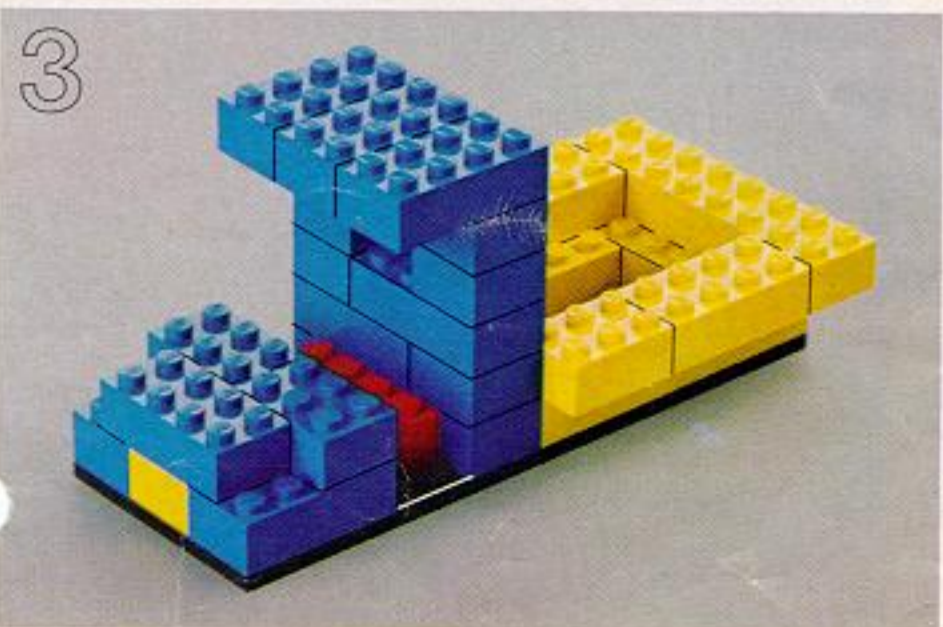
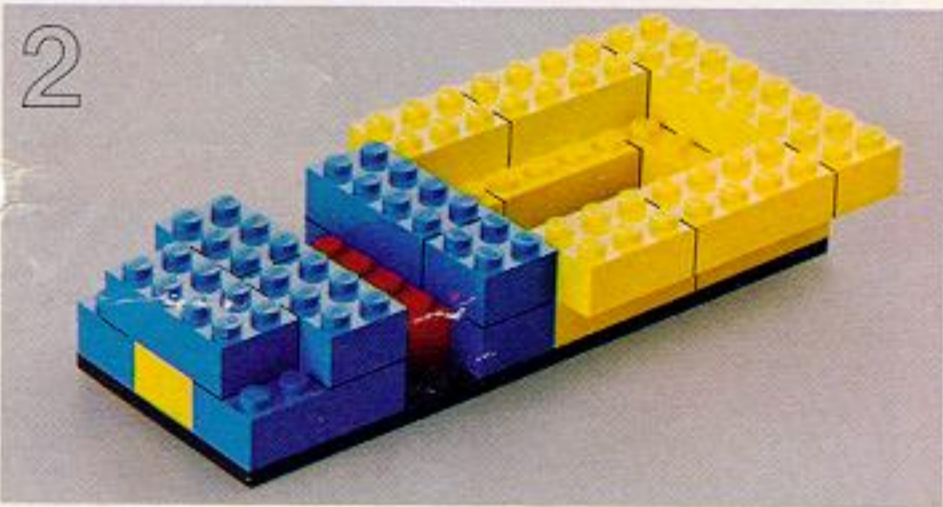
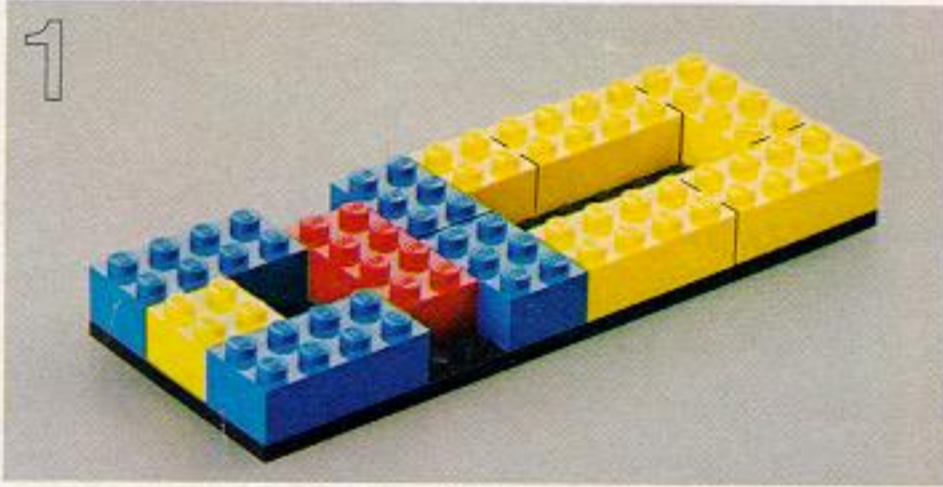

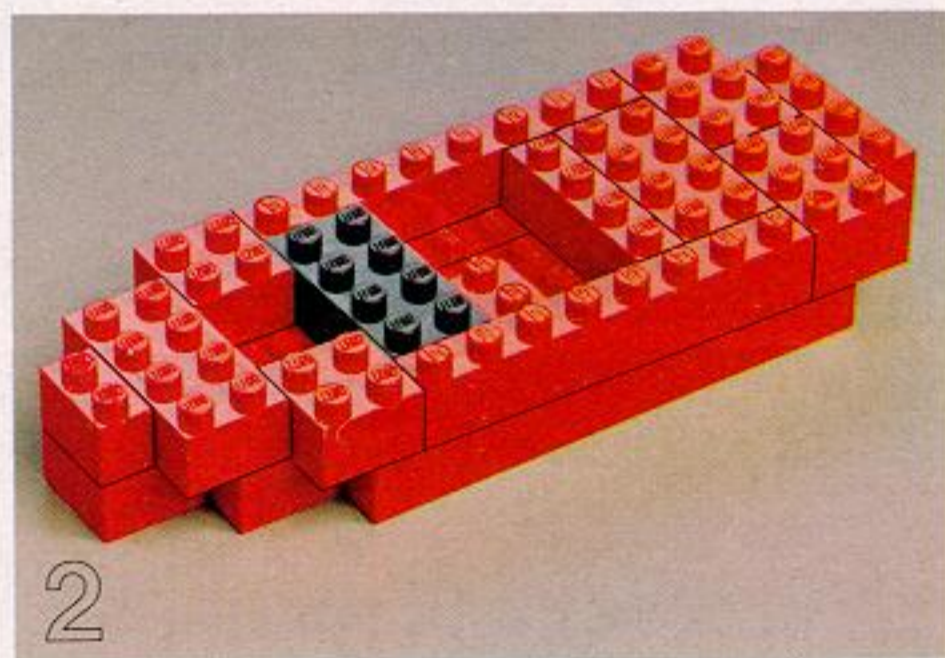
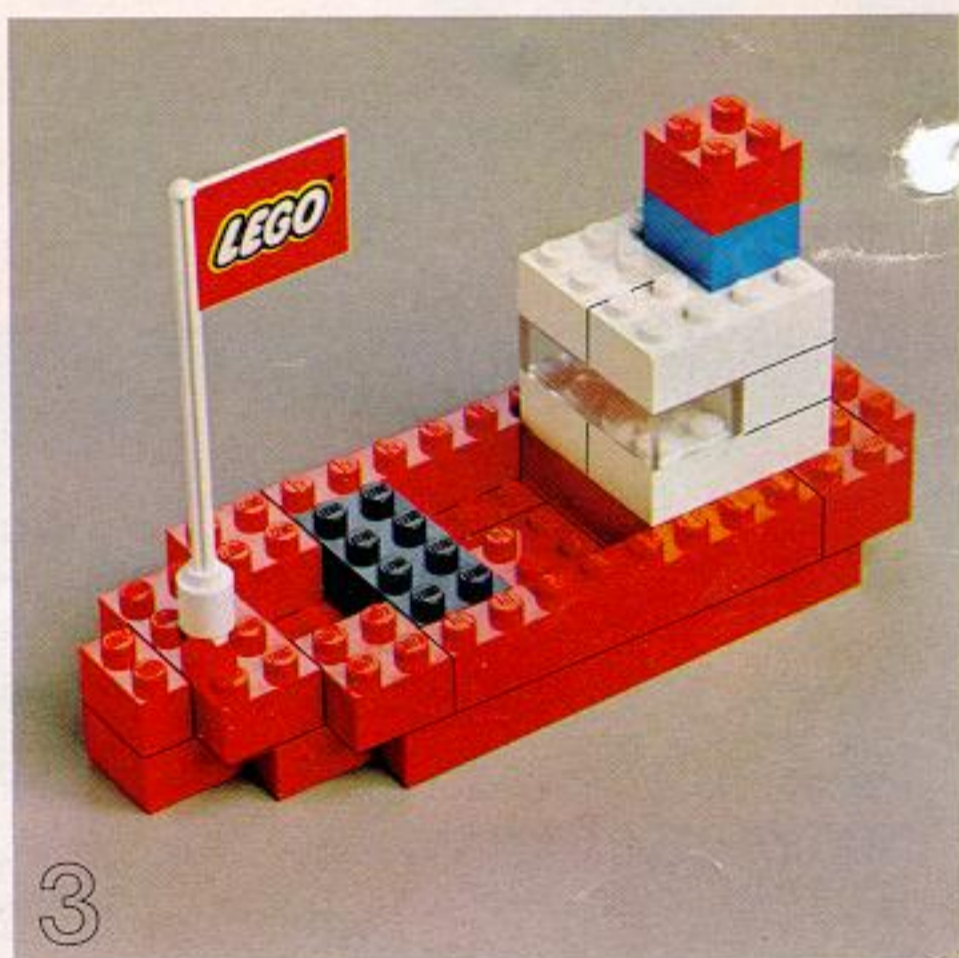
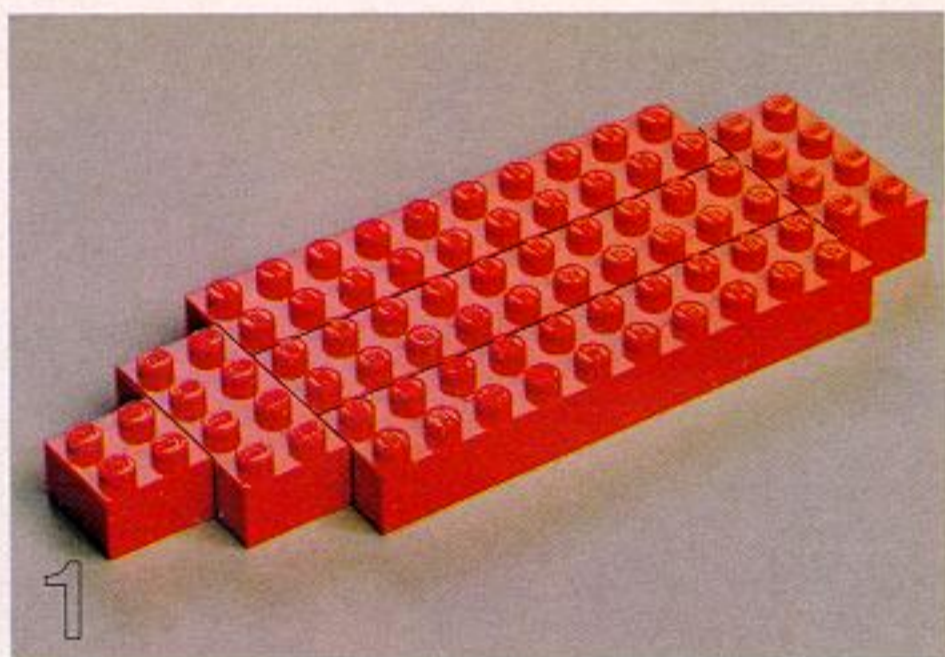
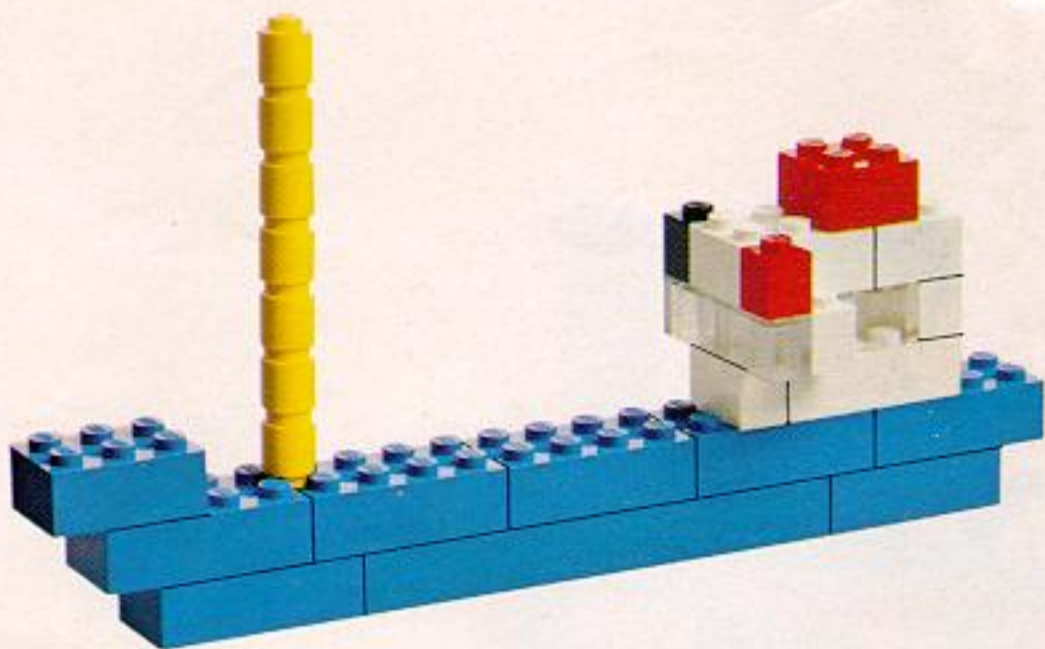

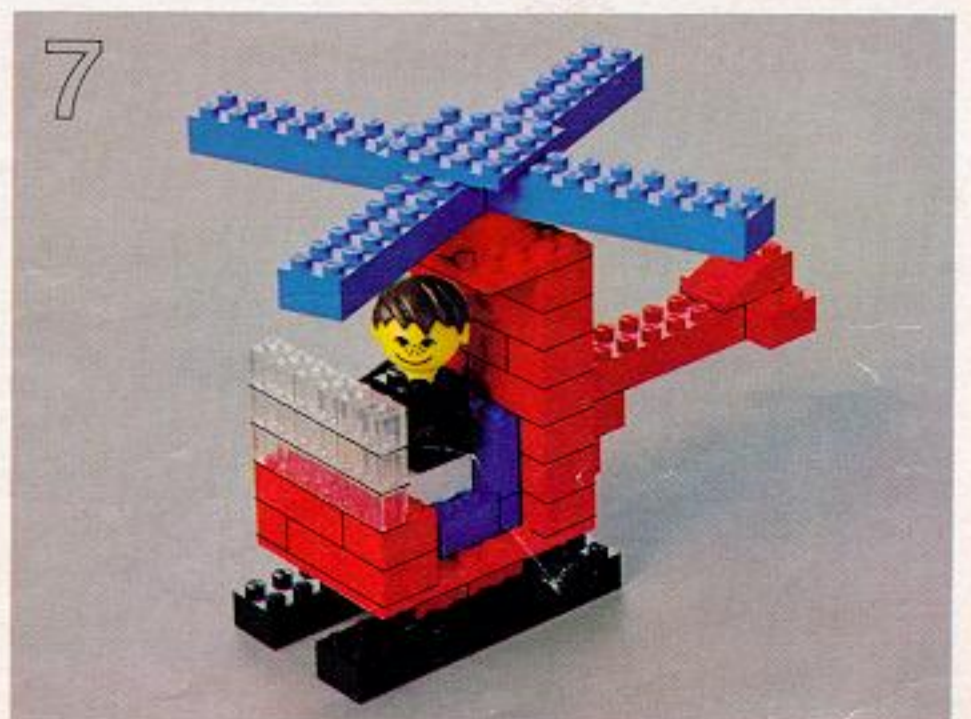
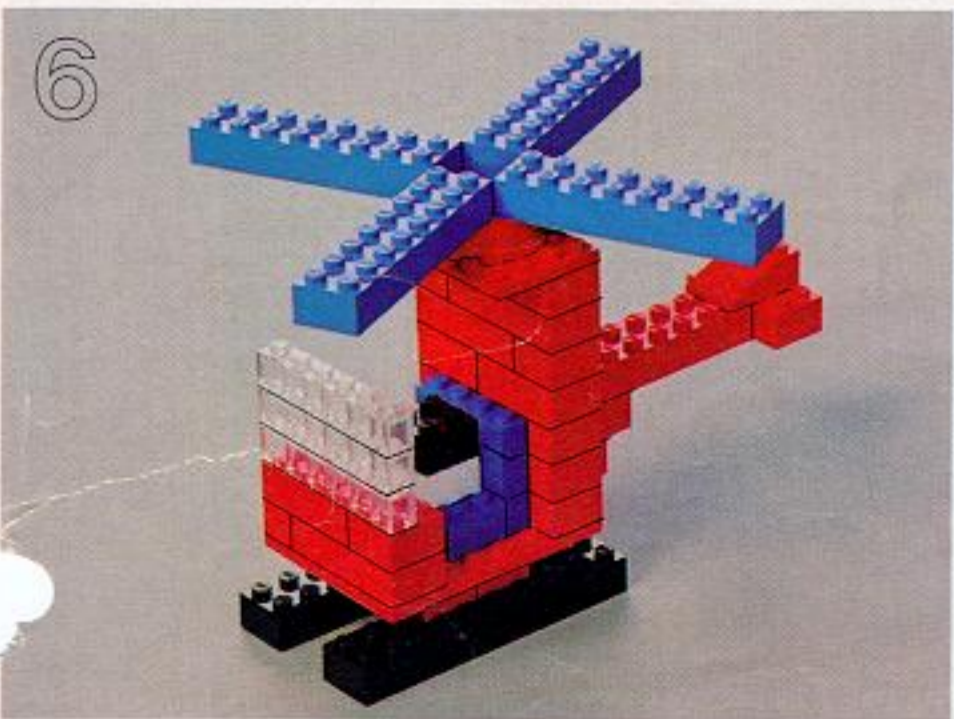
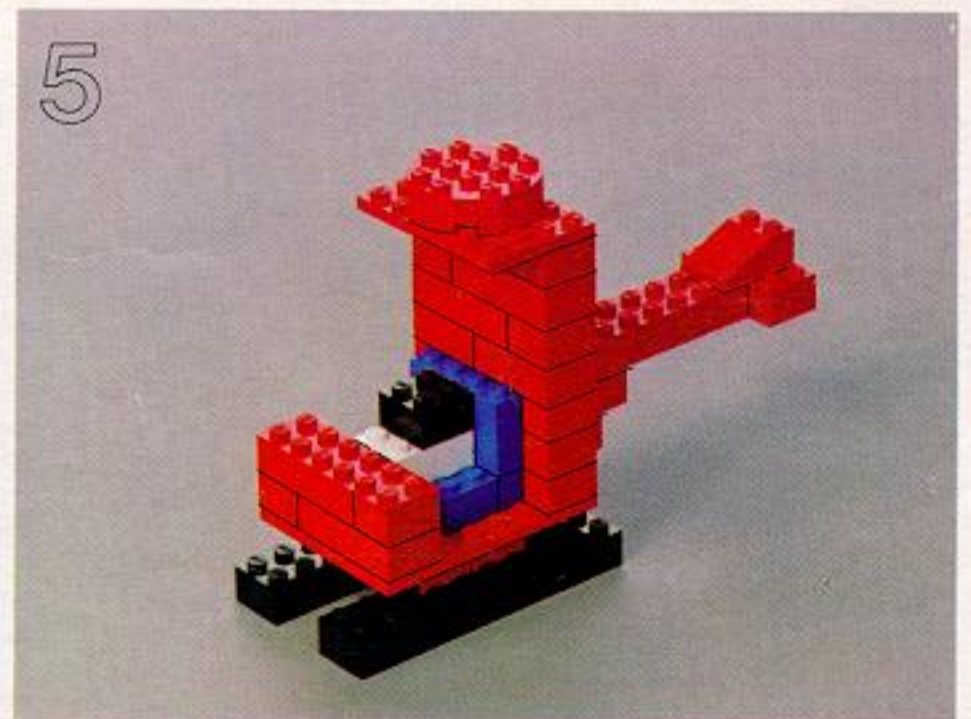
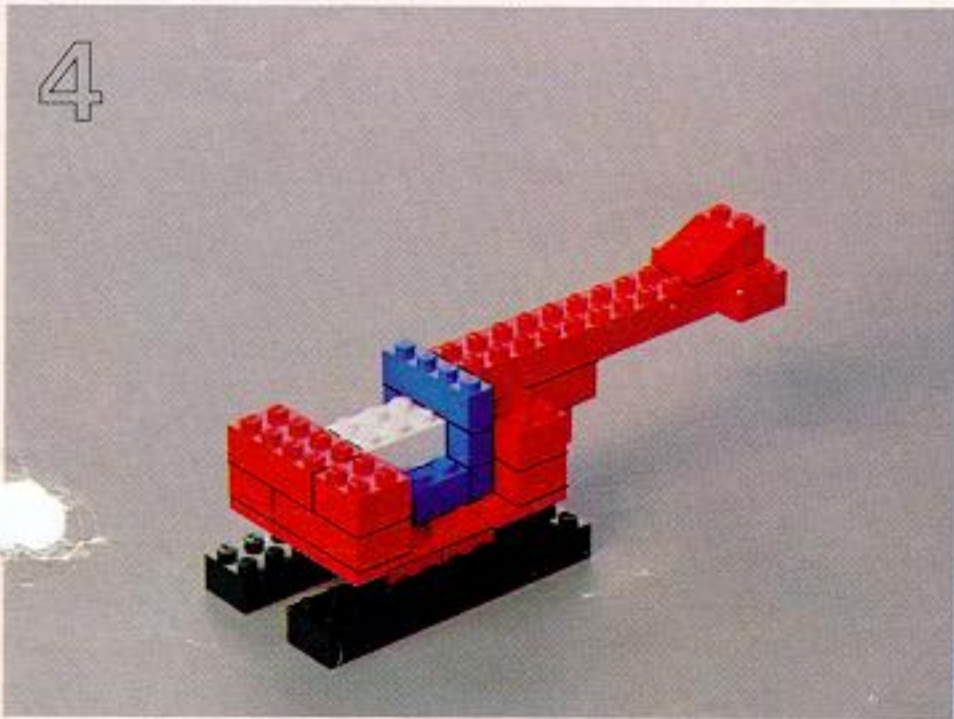
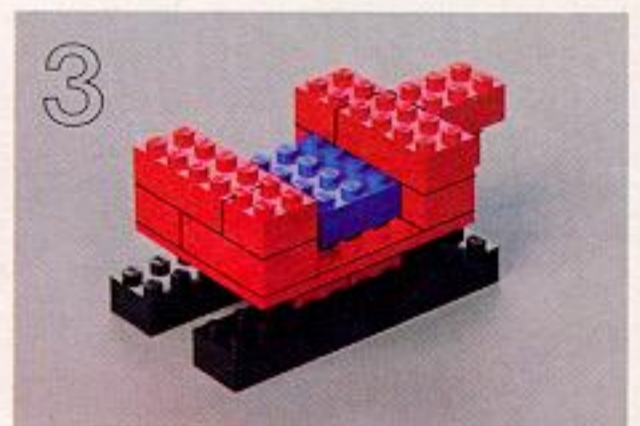
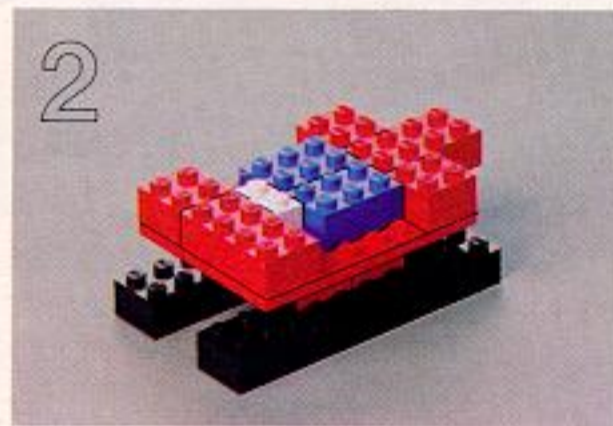
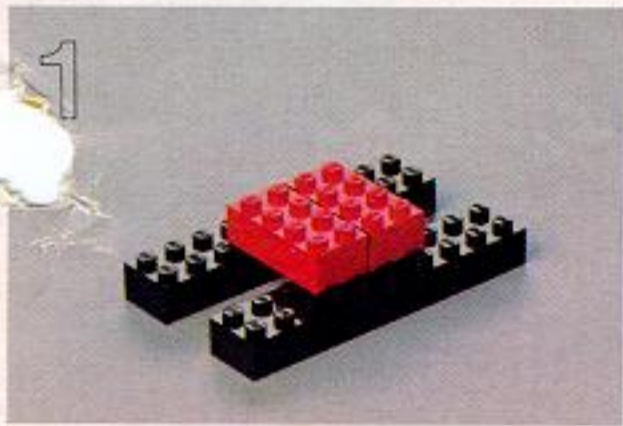
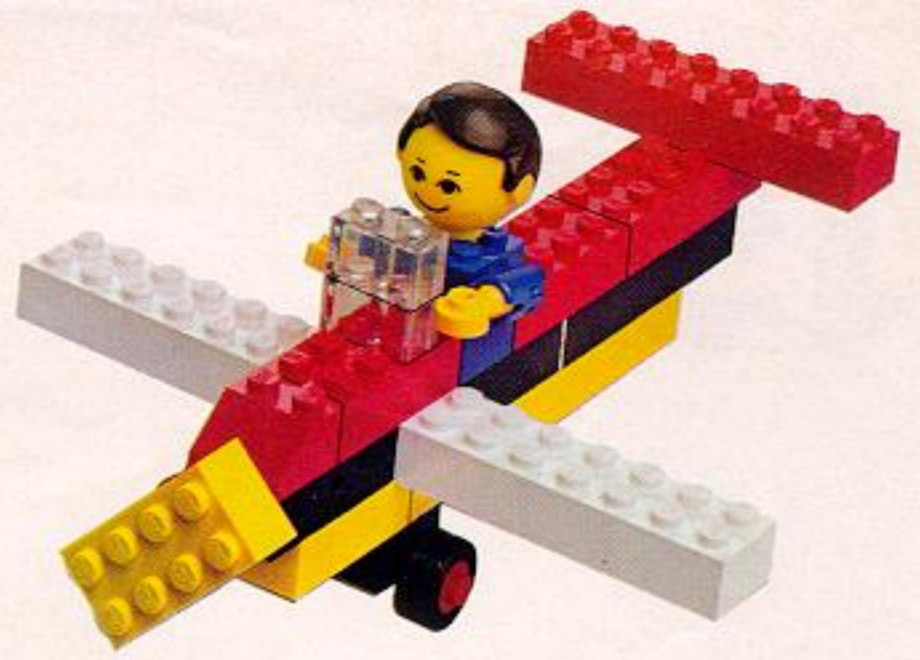



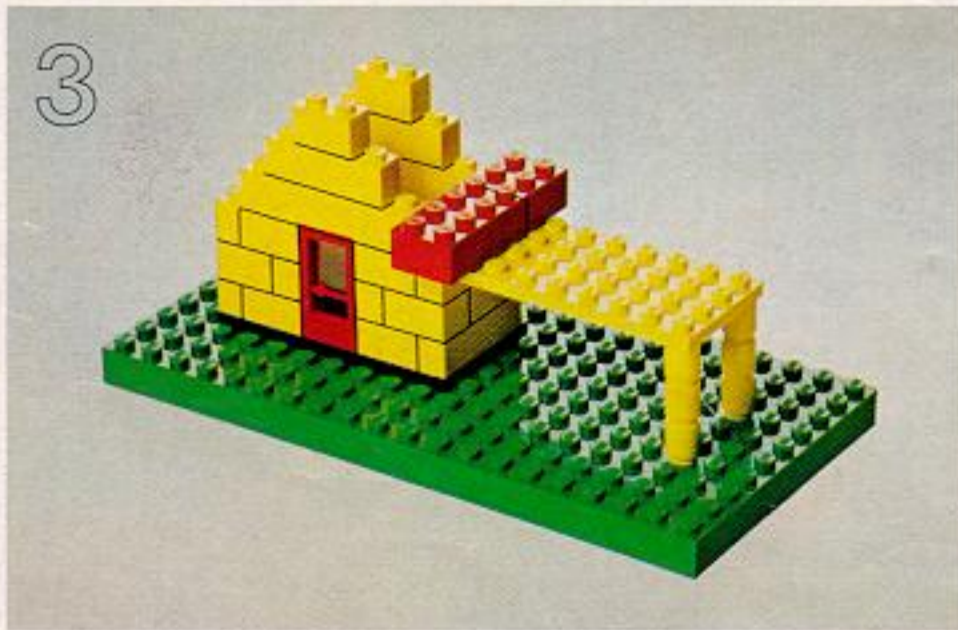
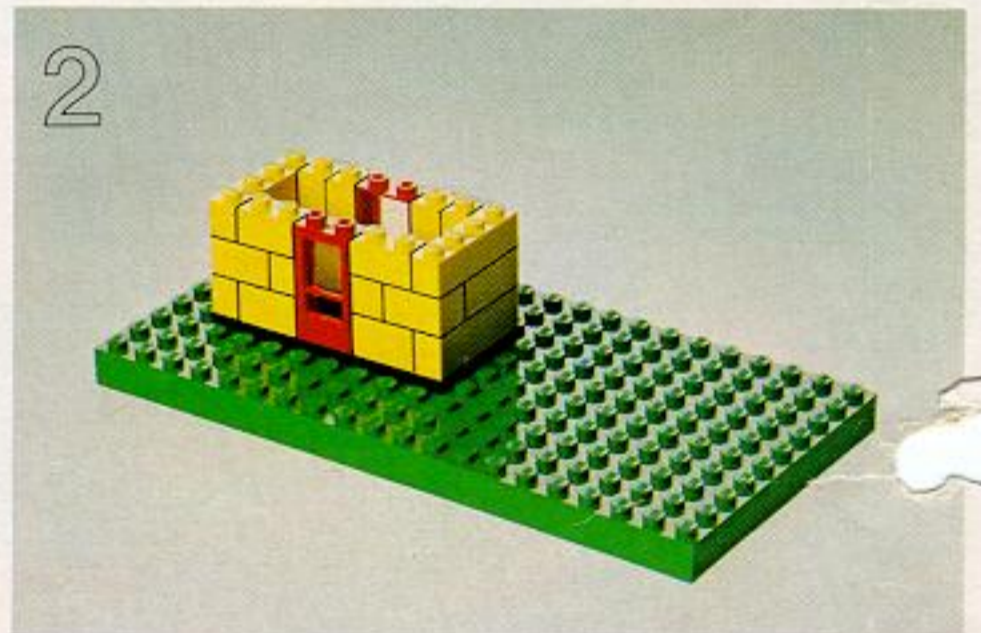
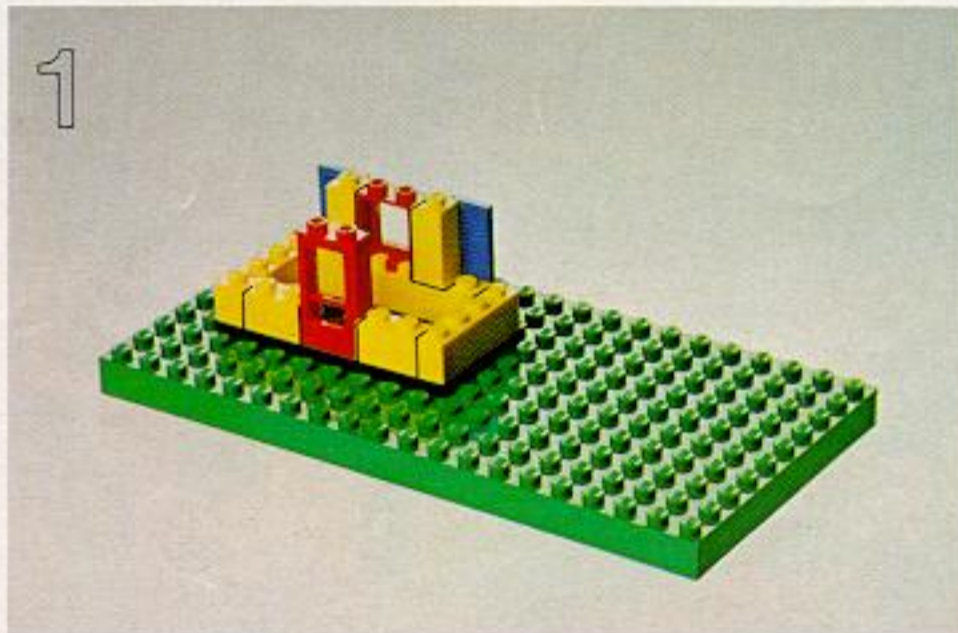
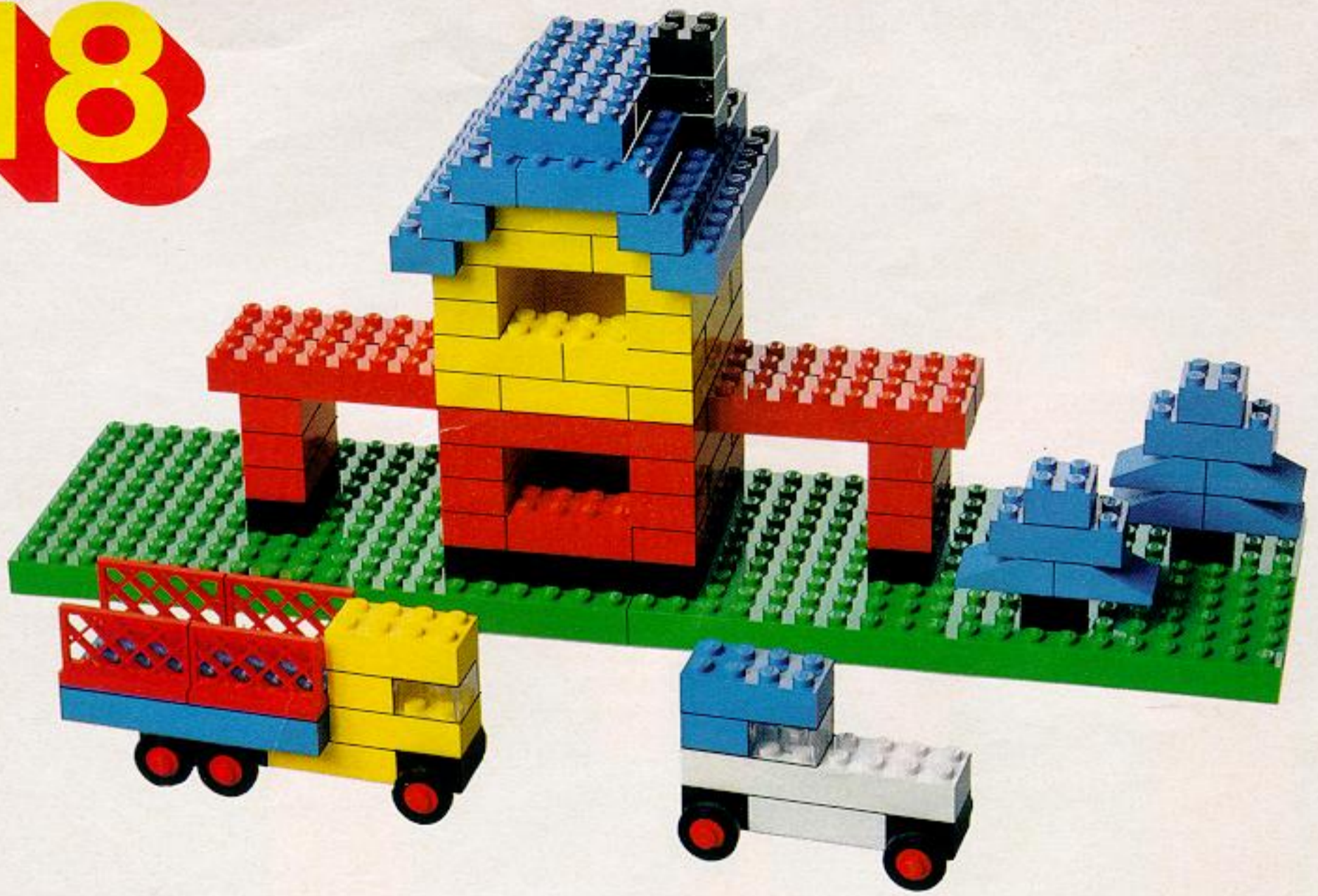

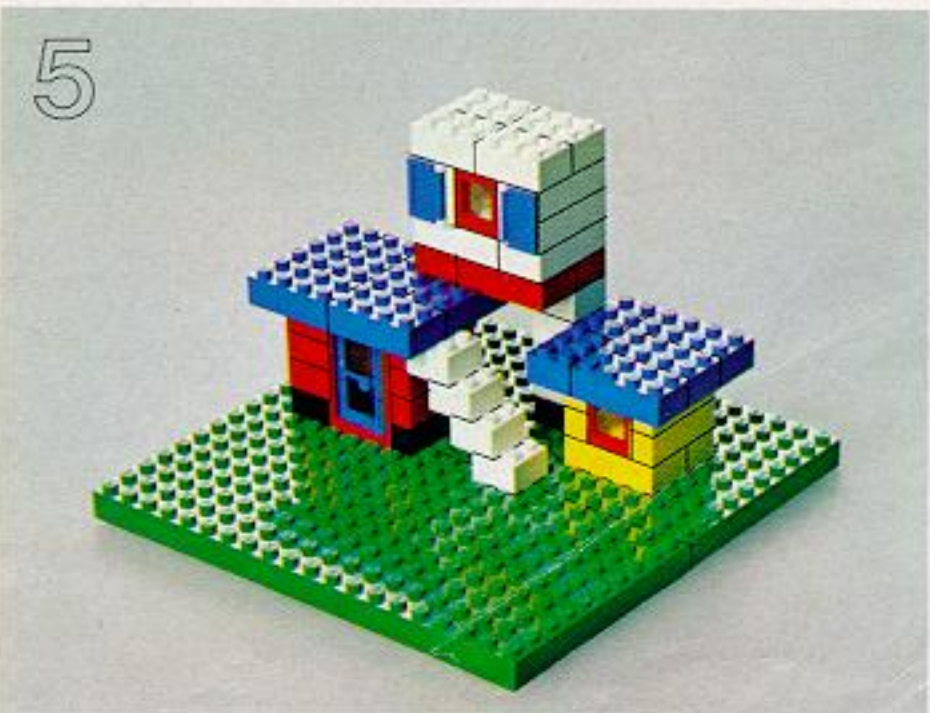
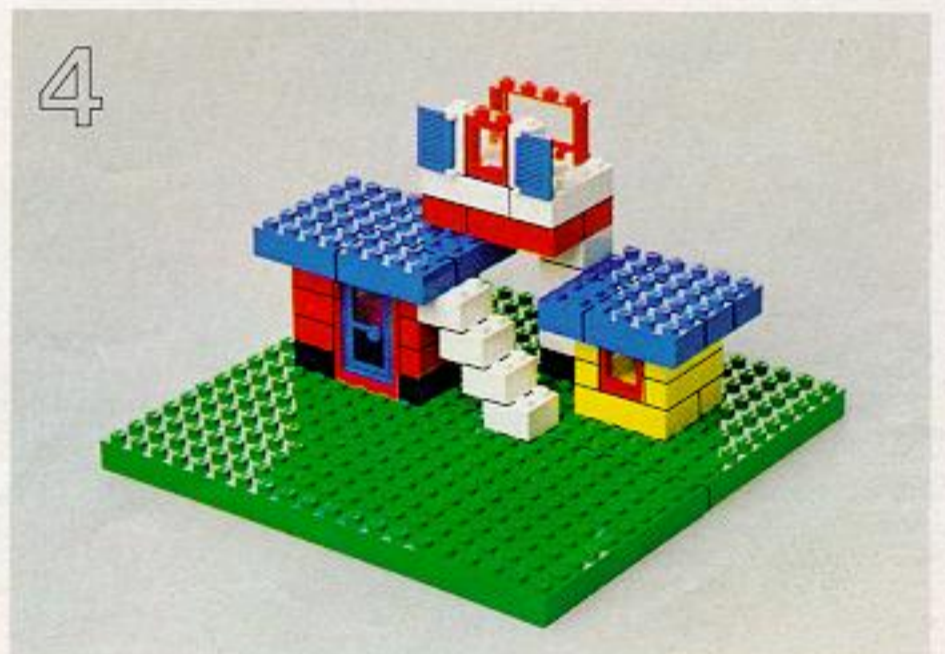
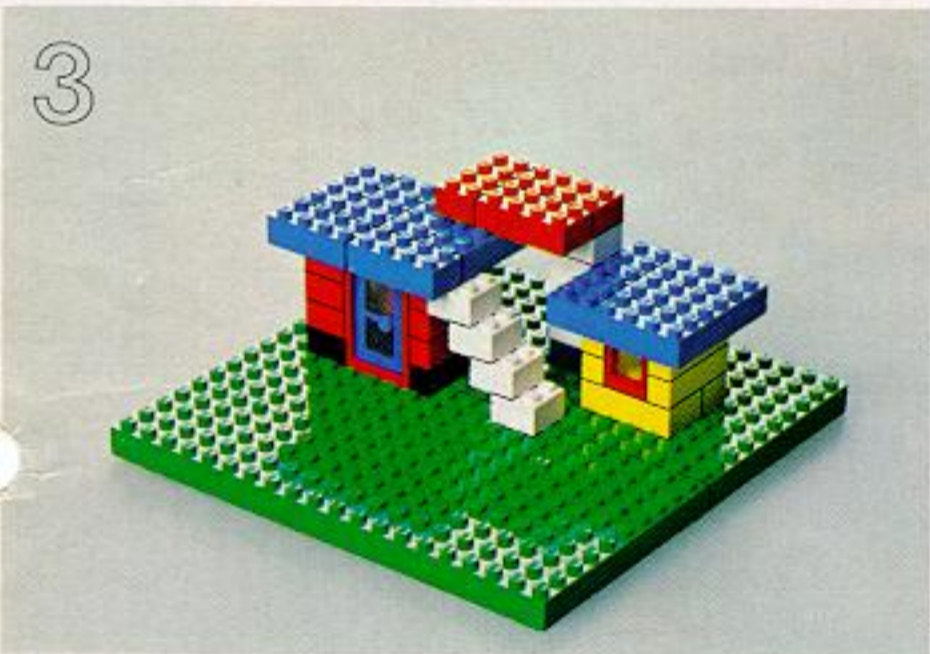
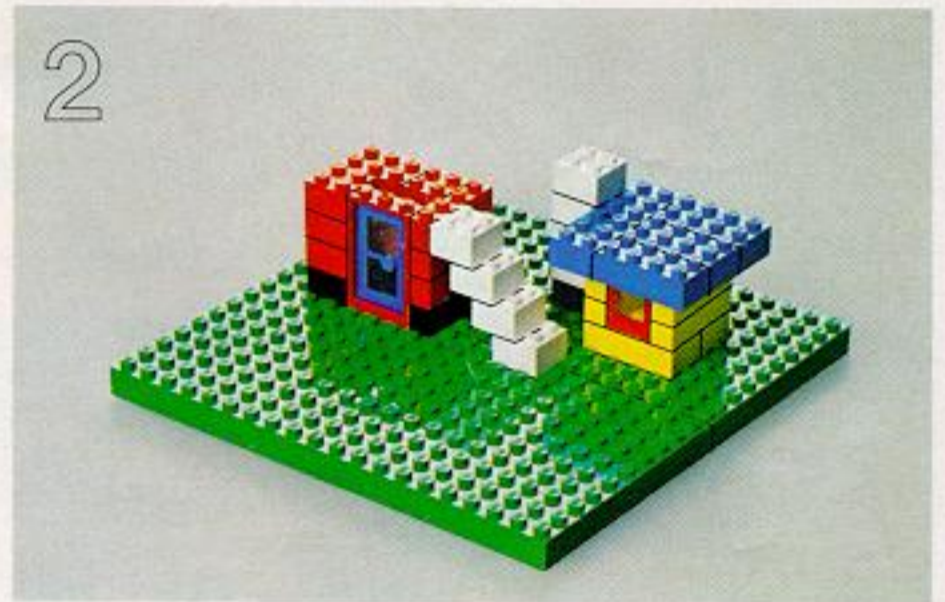
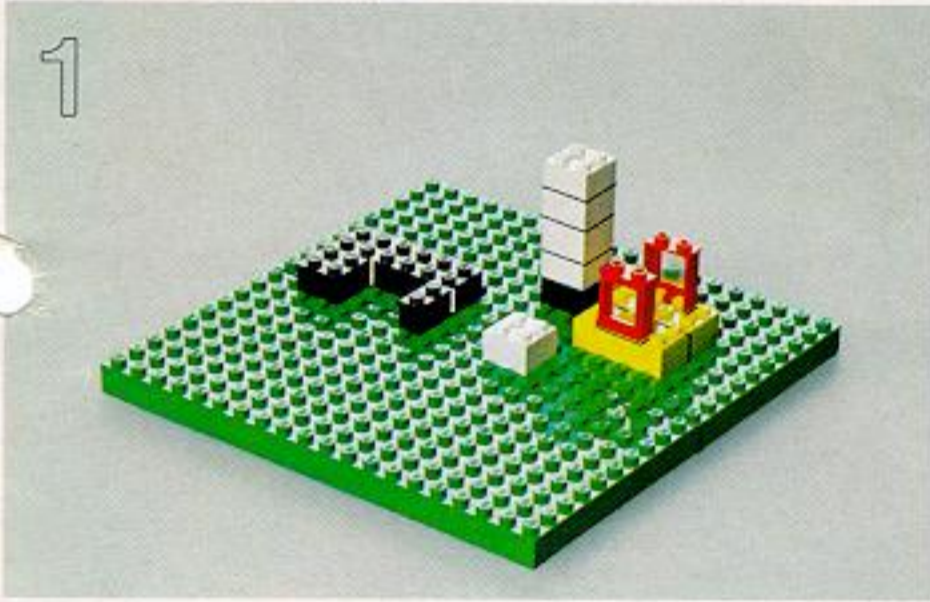

20



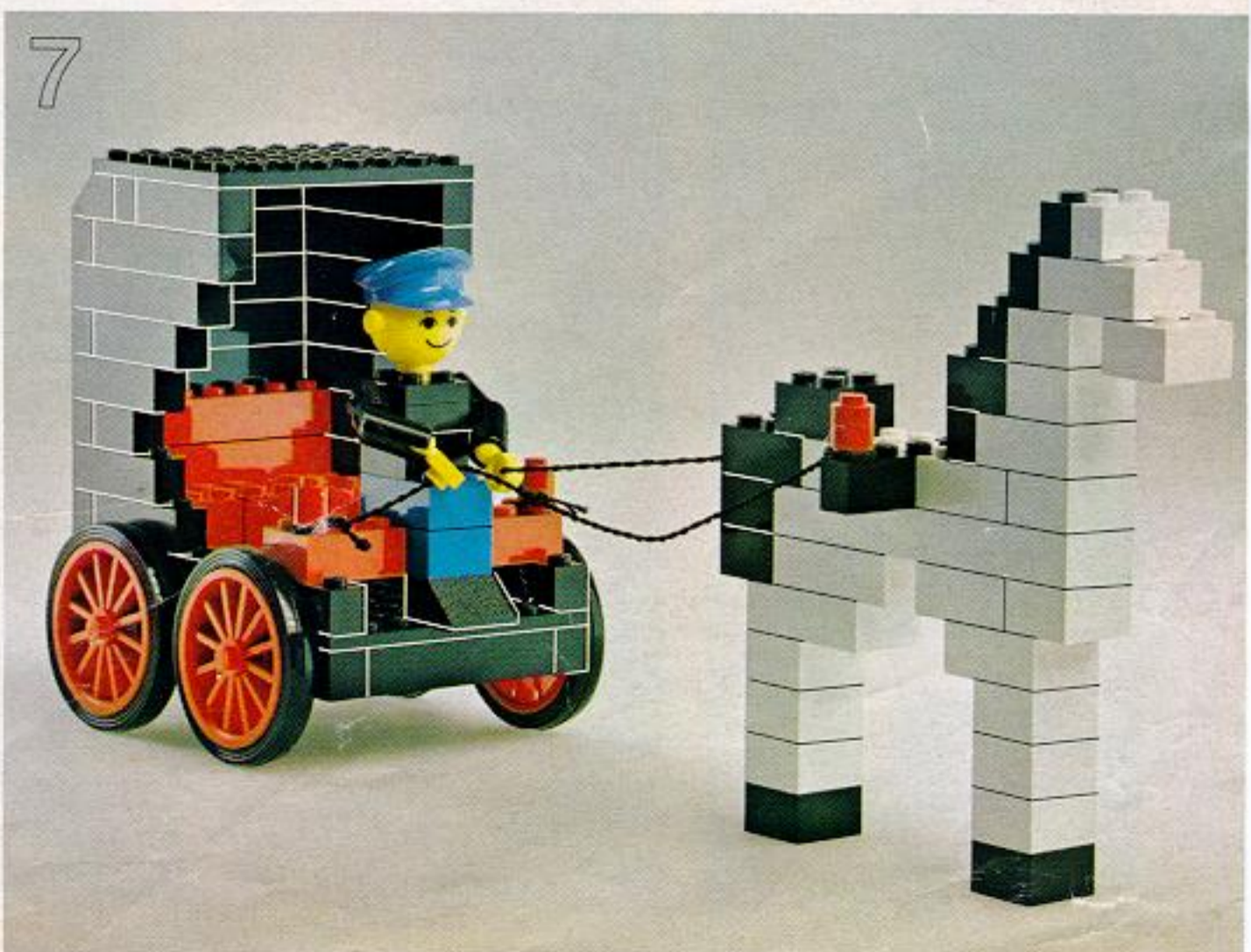
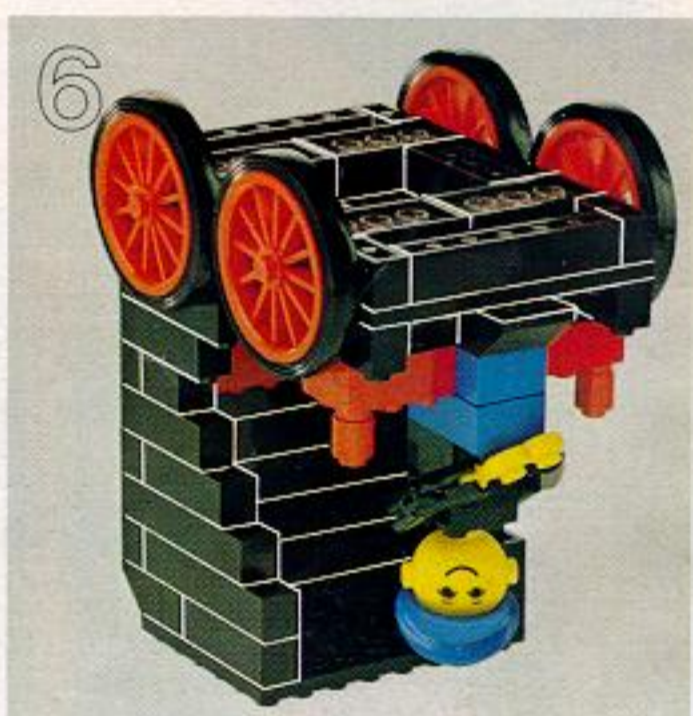
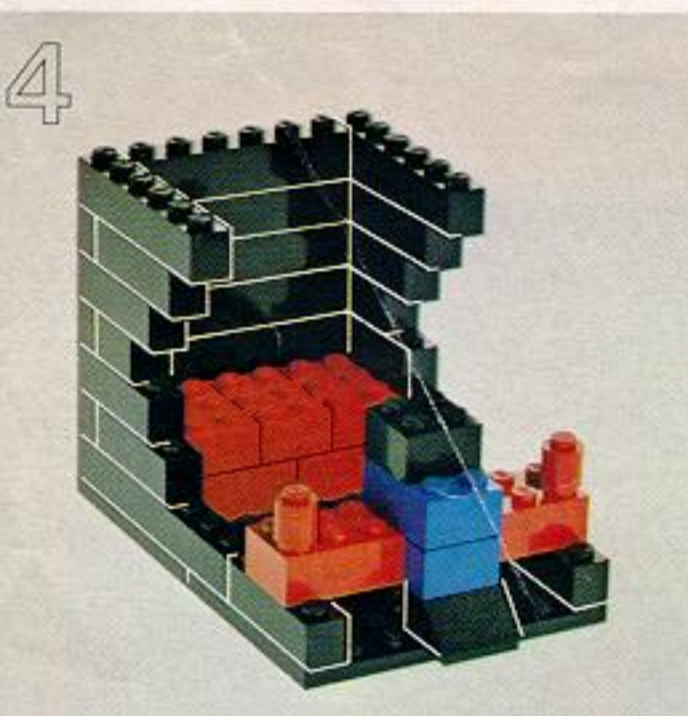
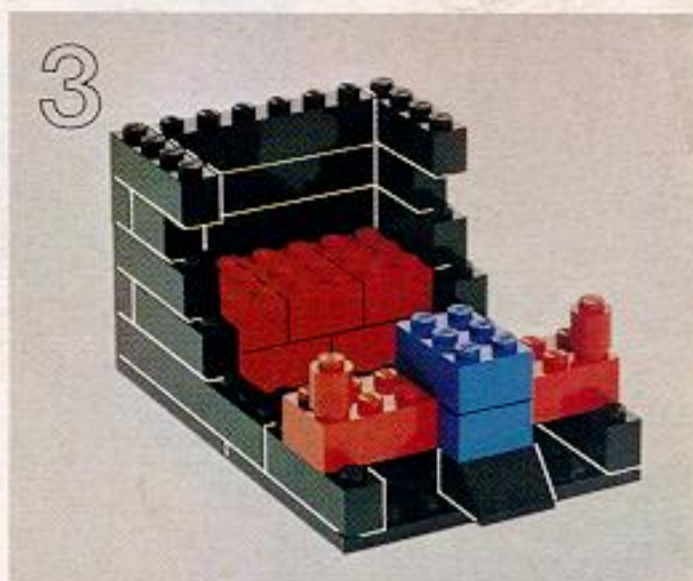
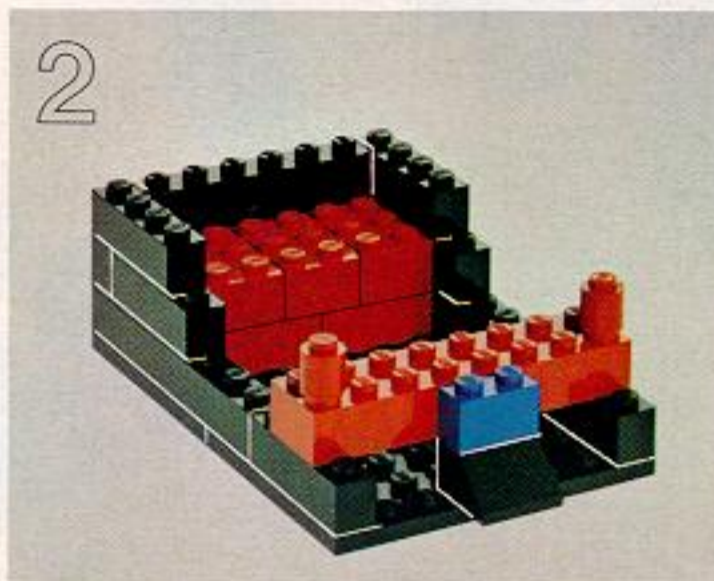
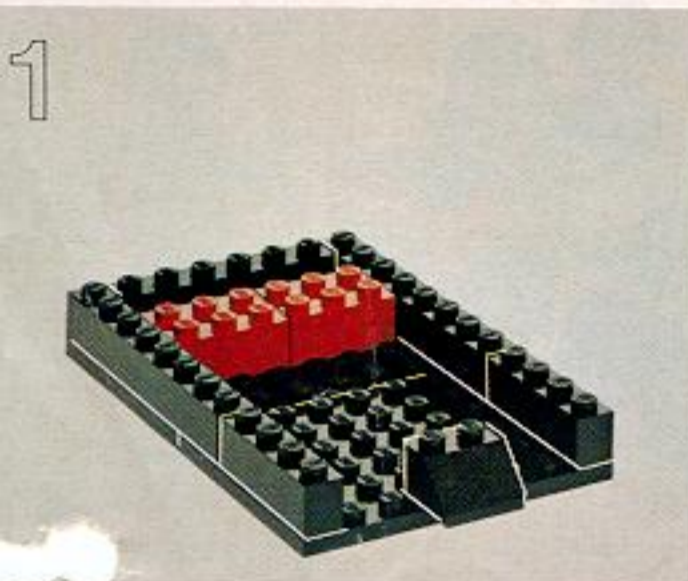

22

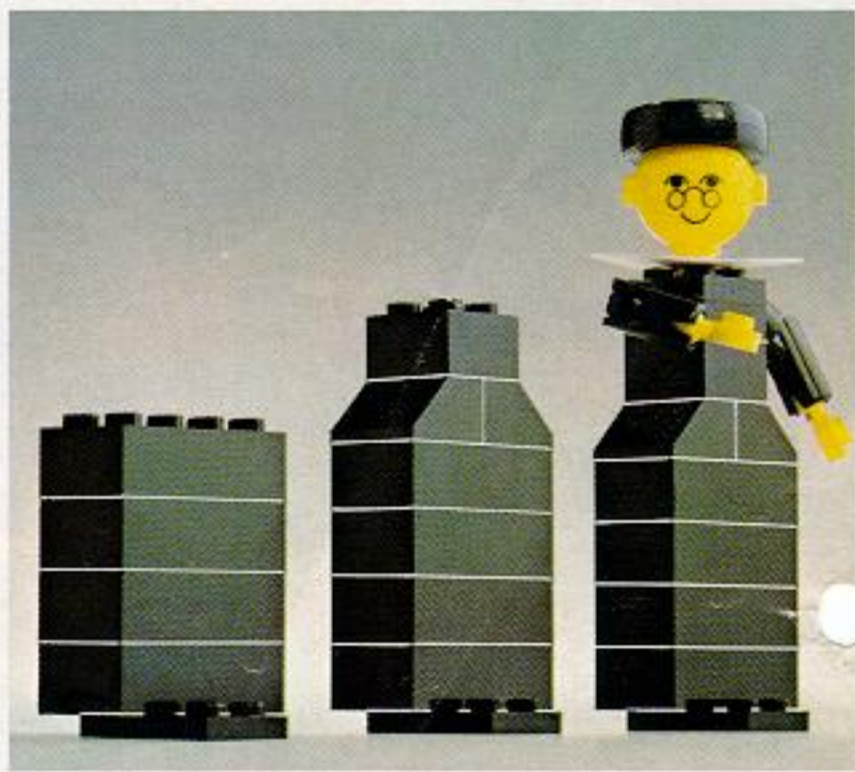
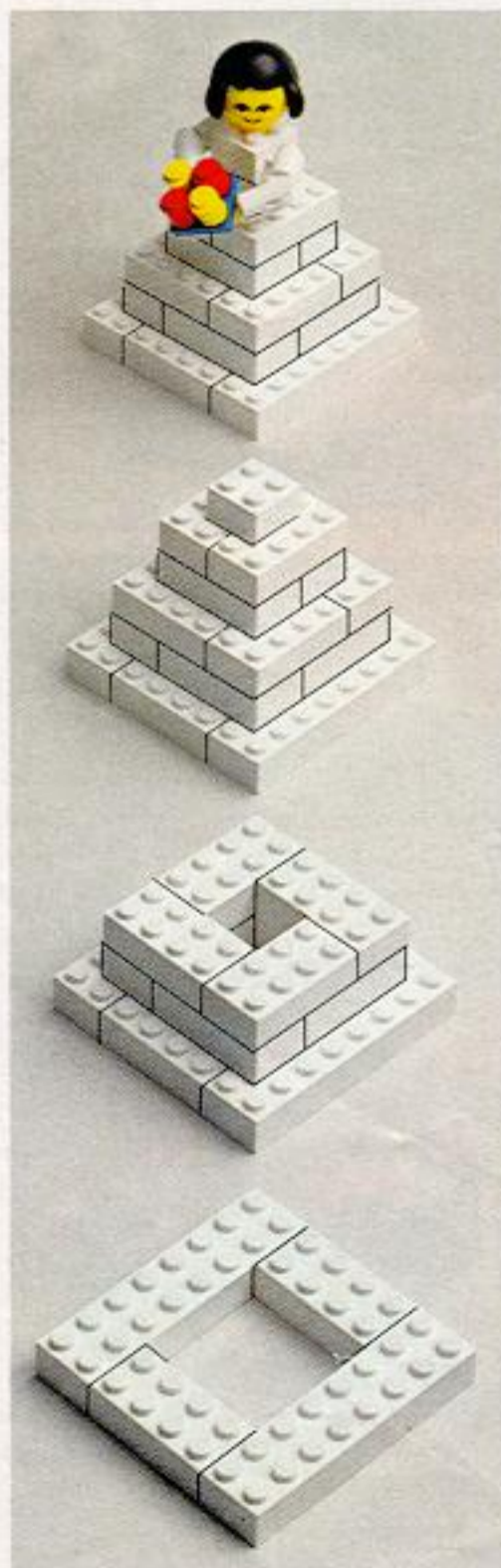
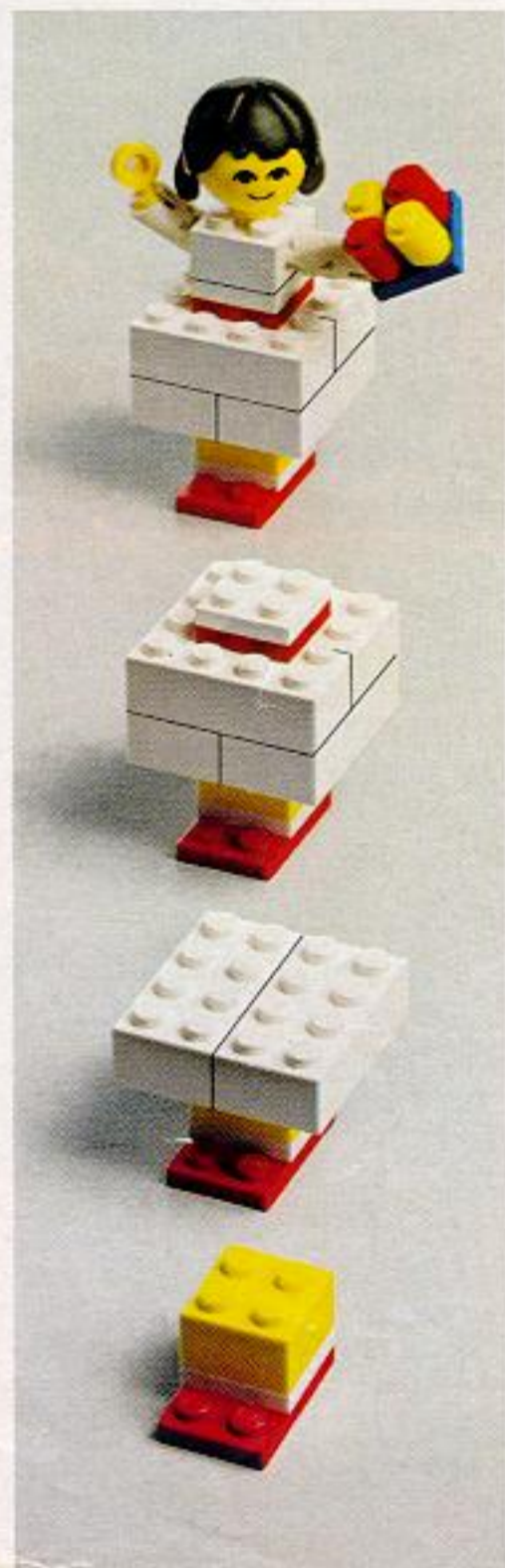
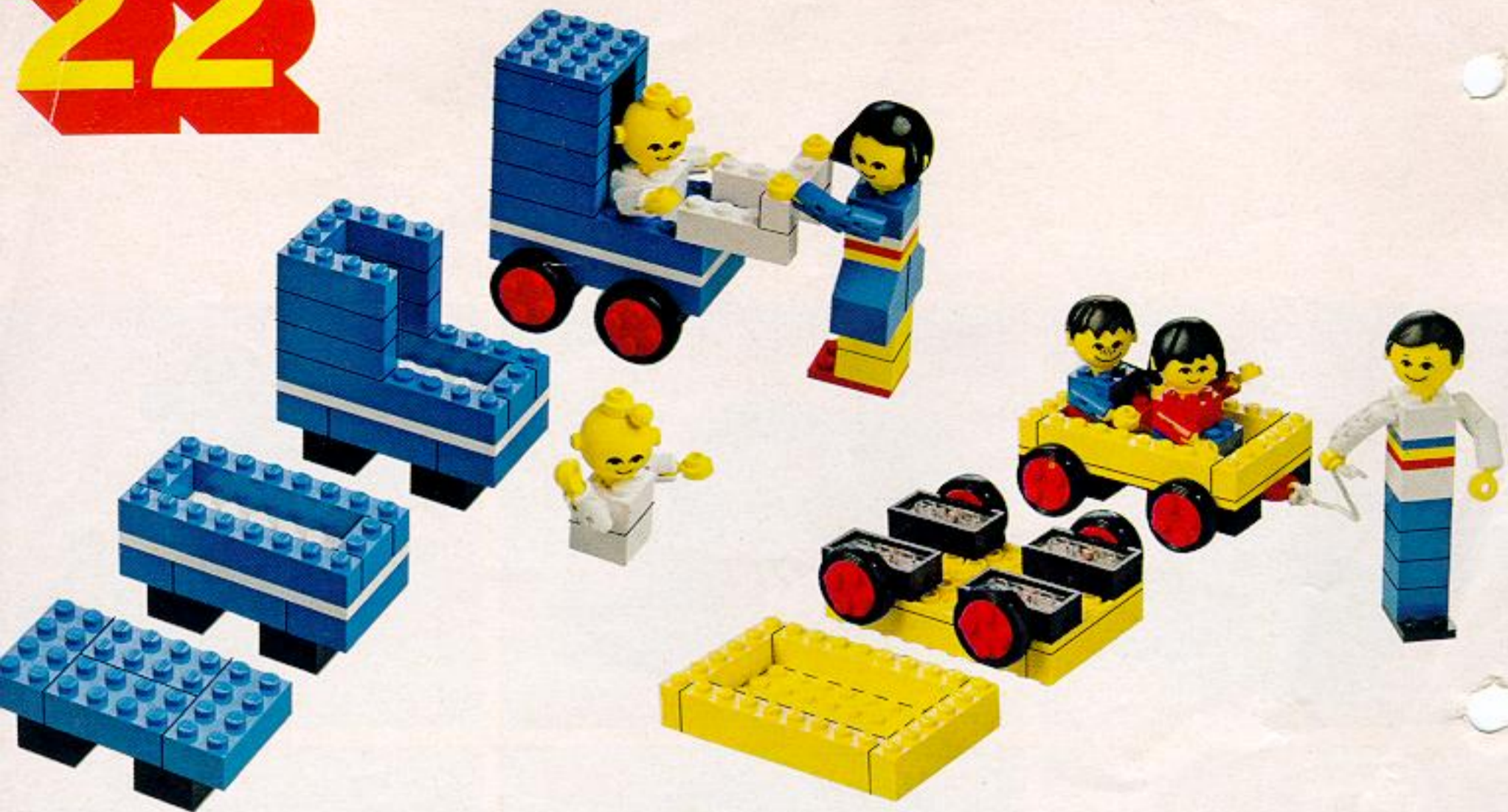



21

21

24

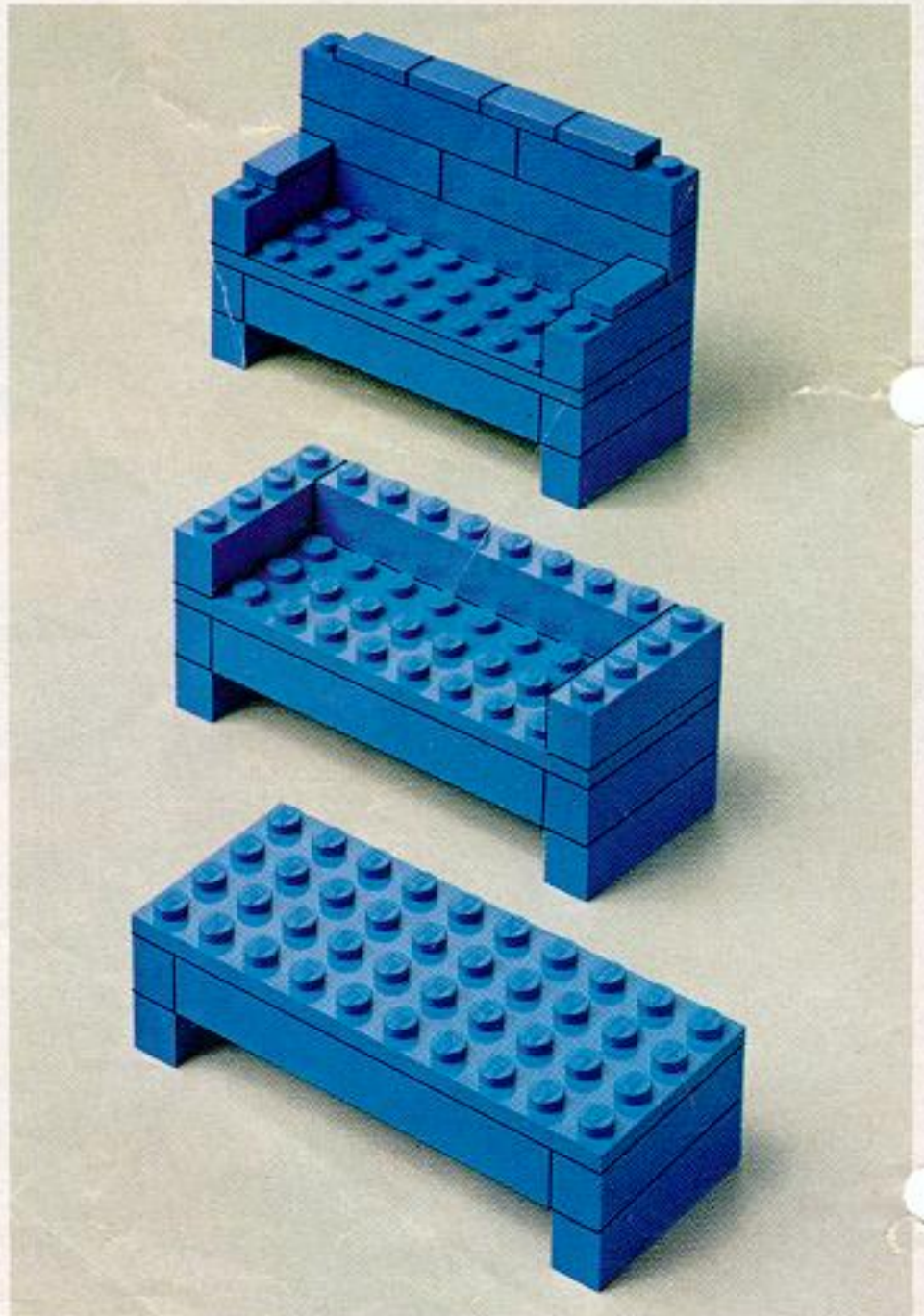
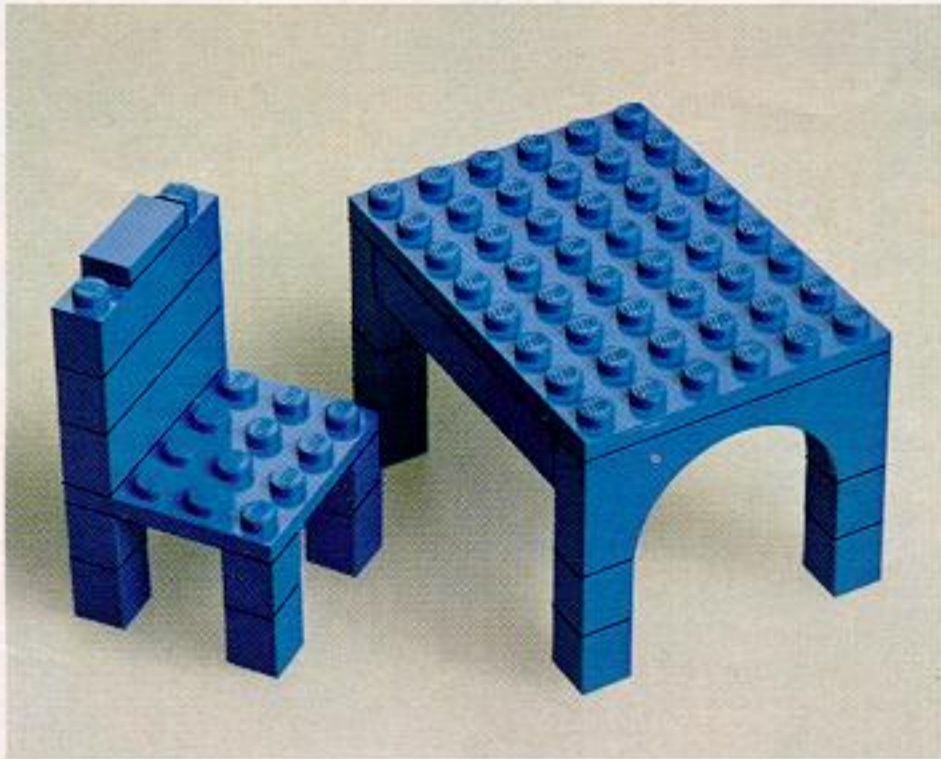
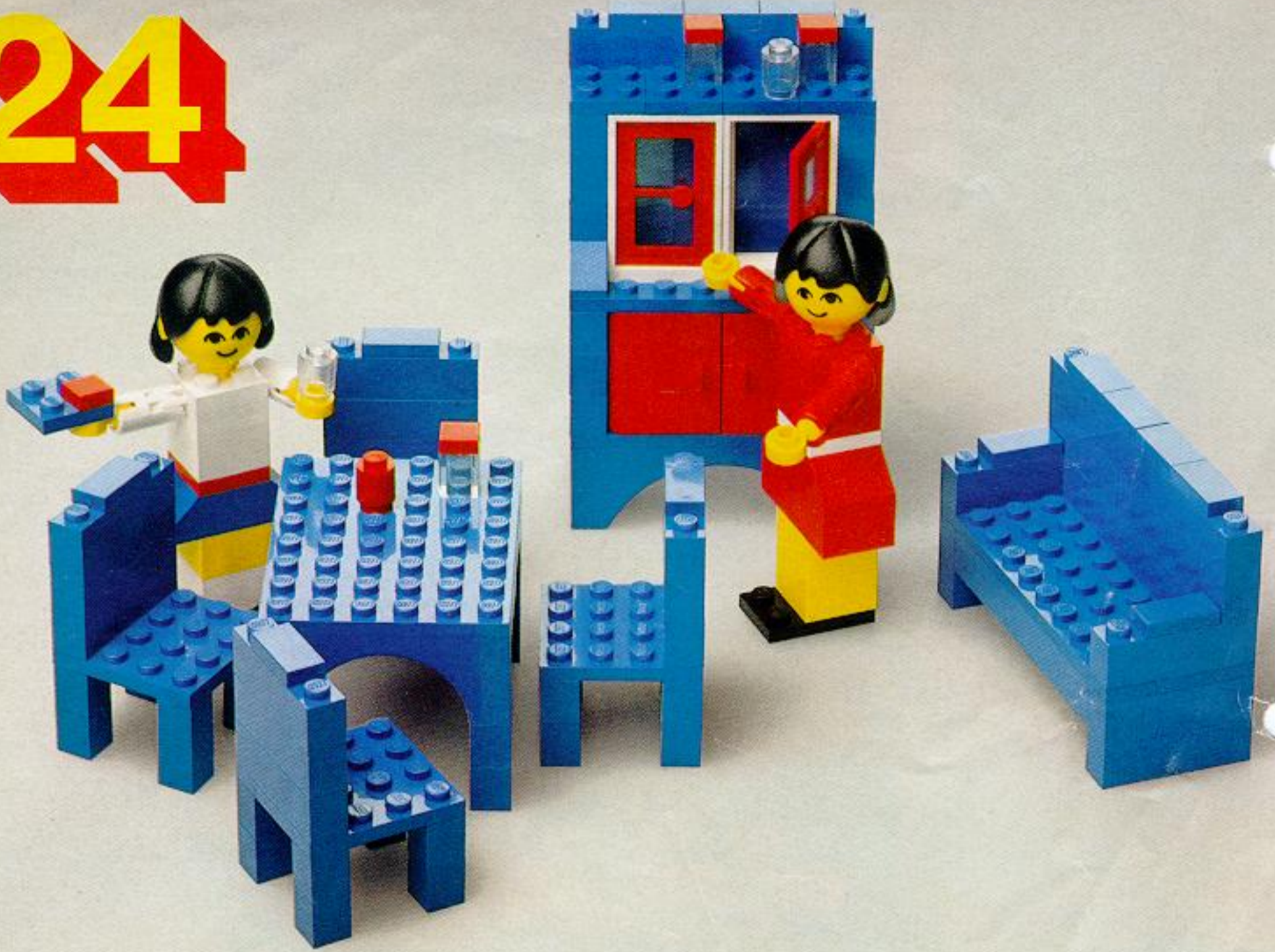

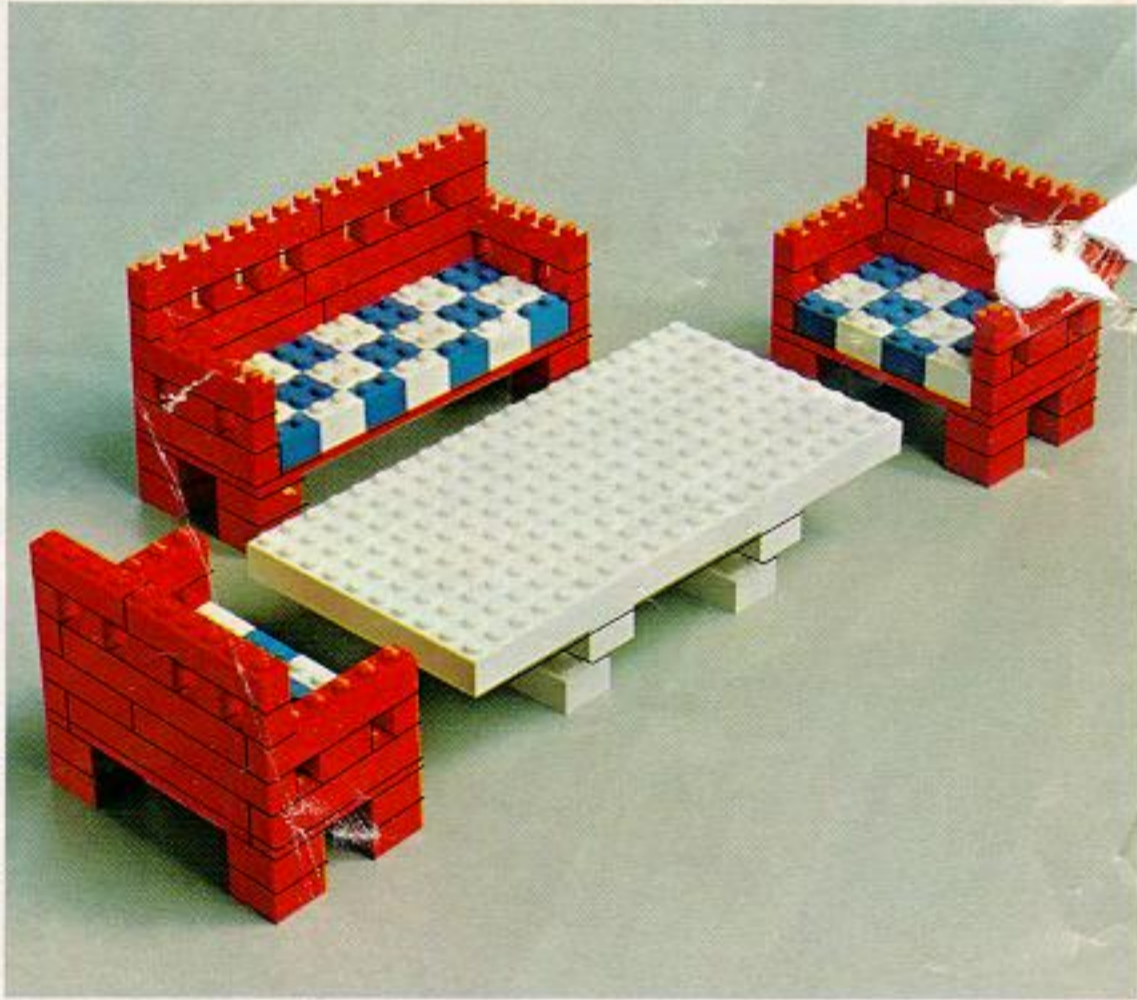
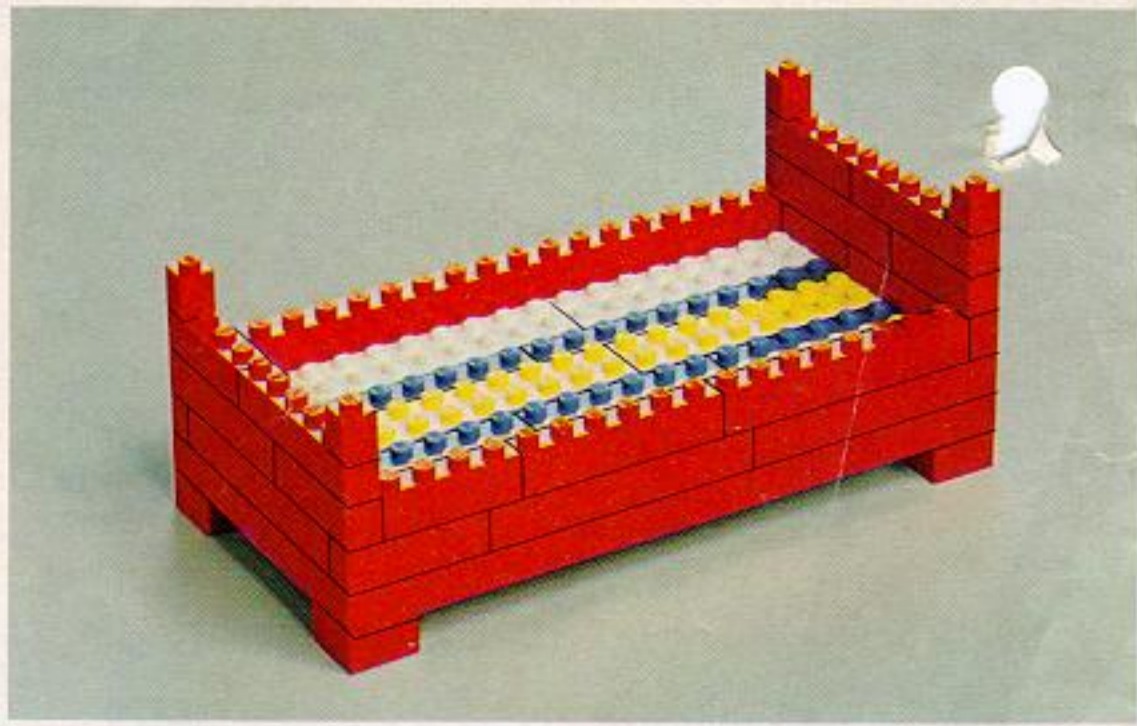

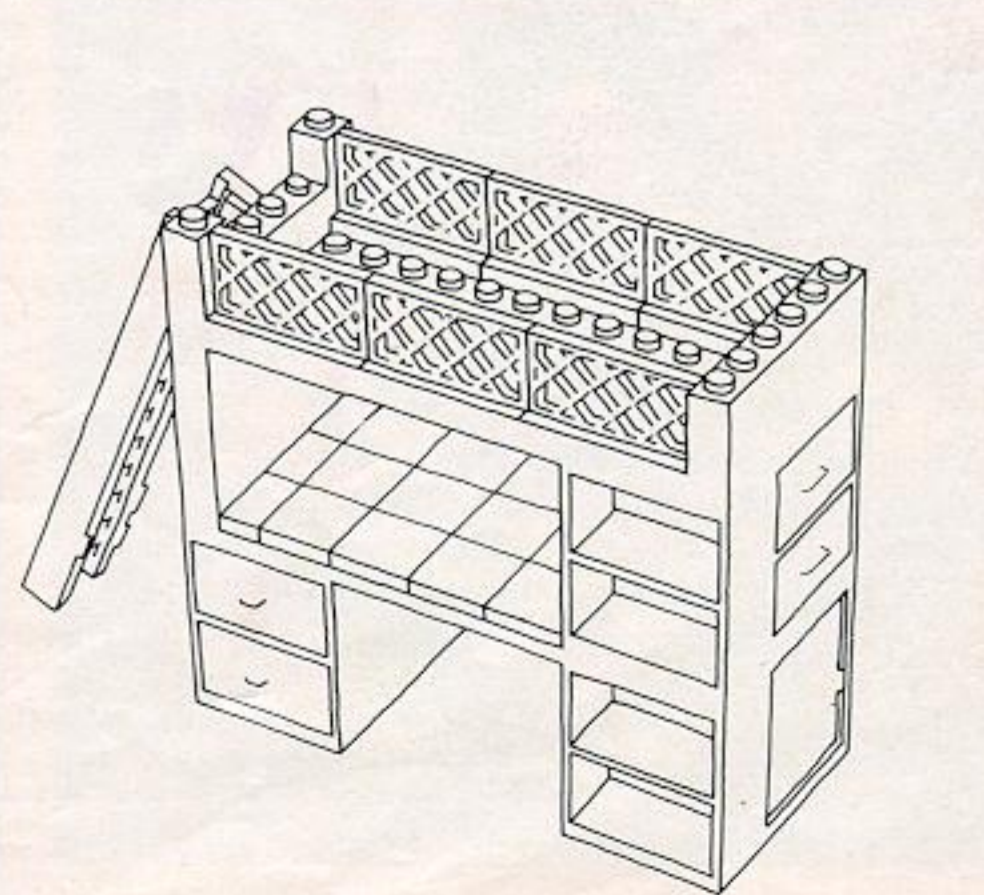
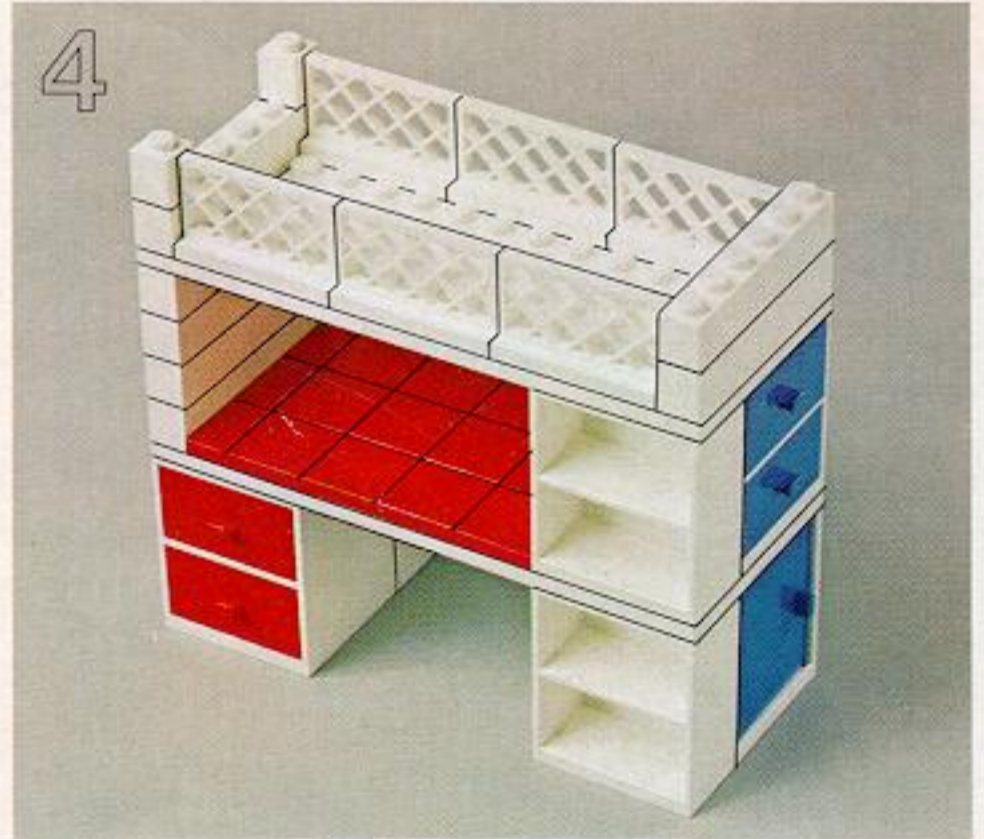
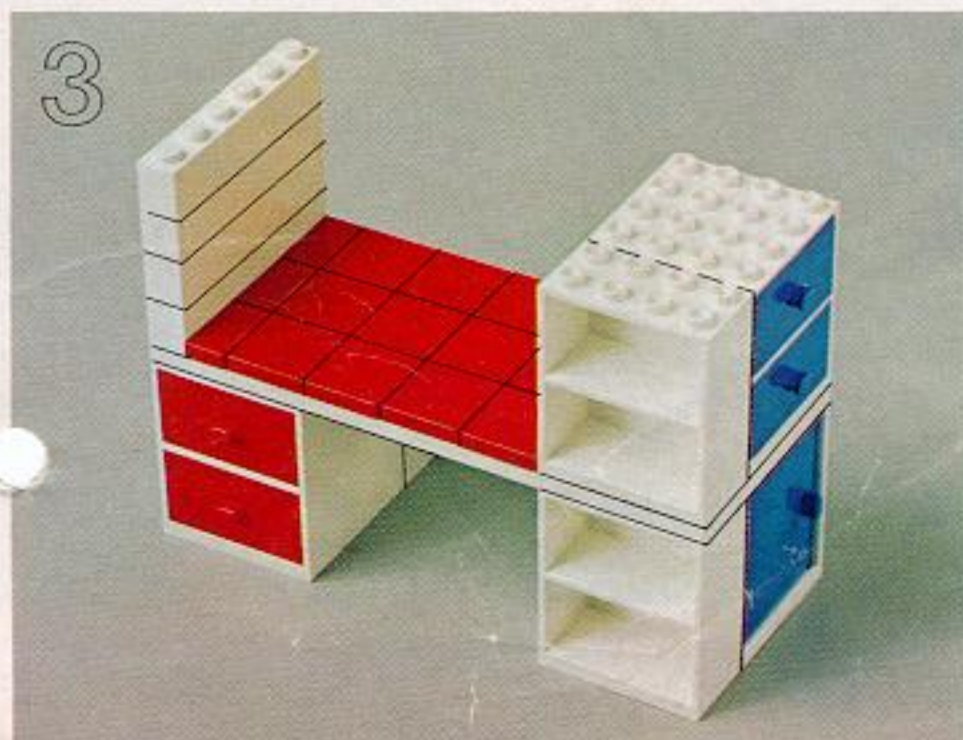
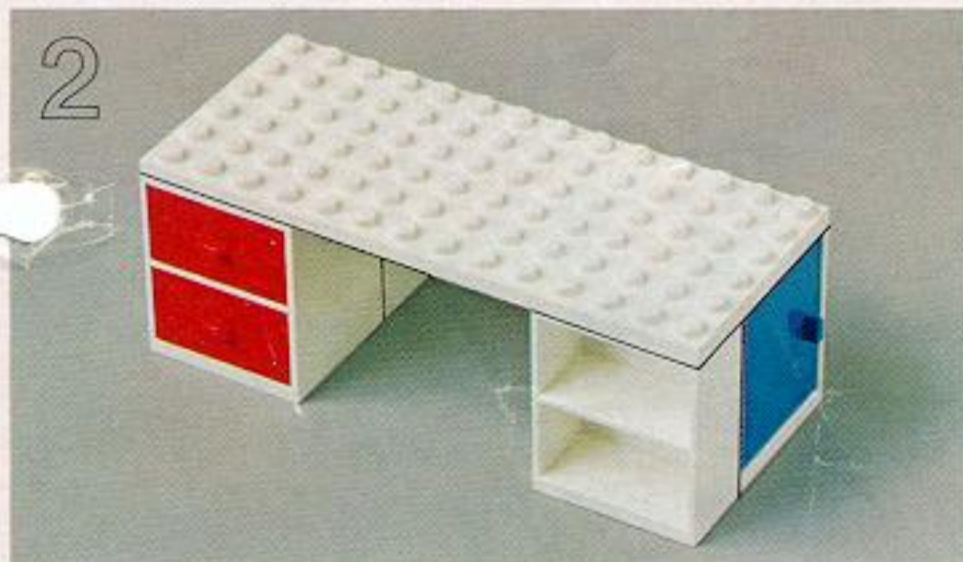
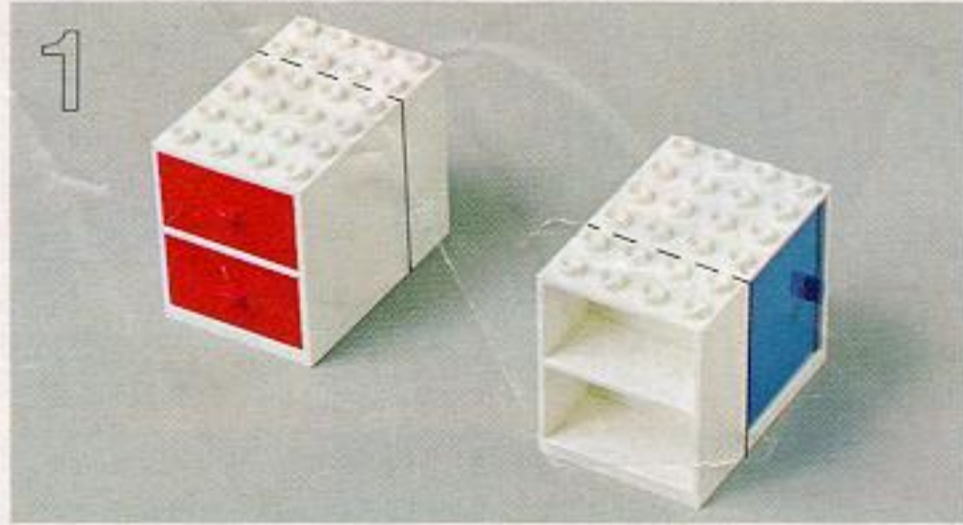

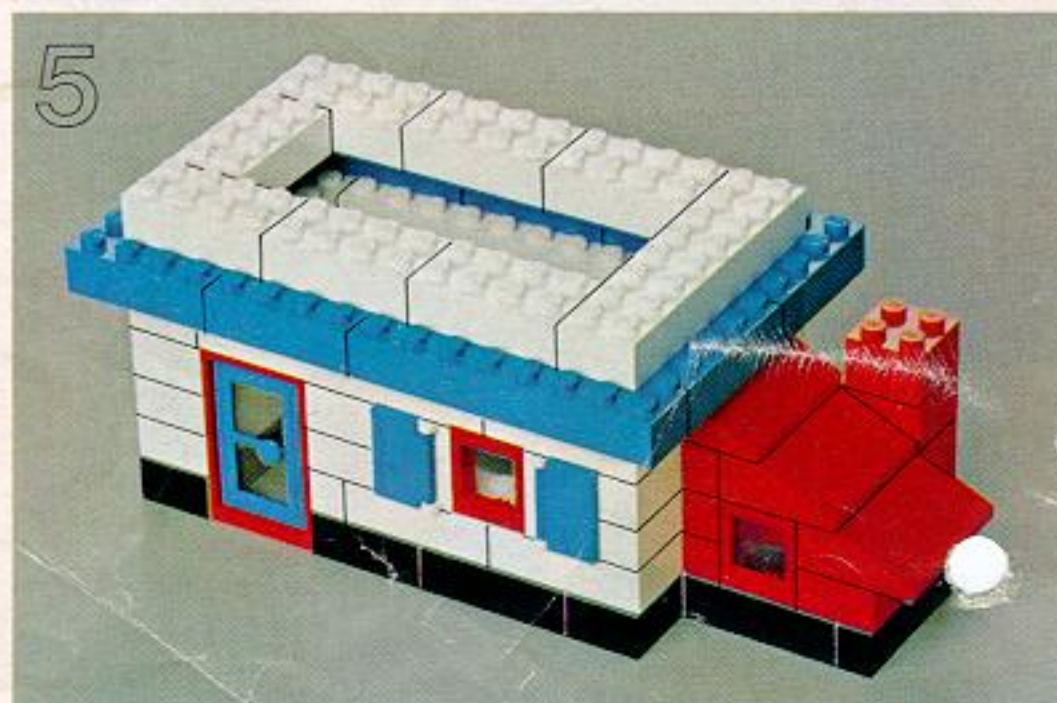
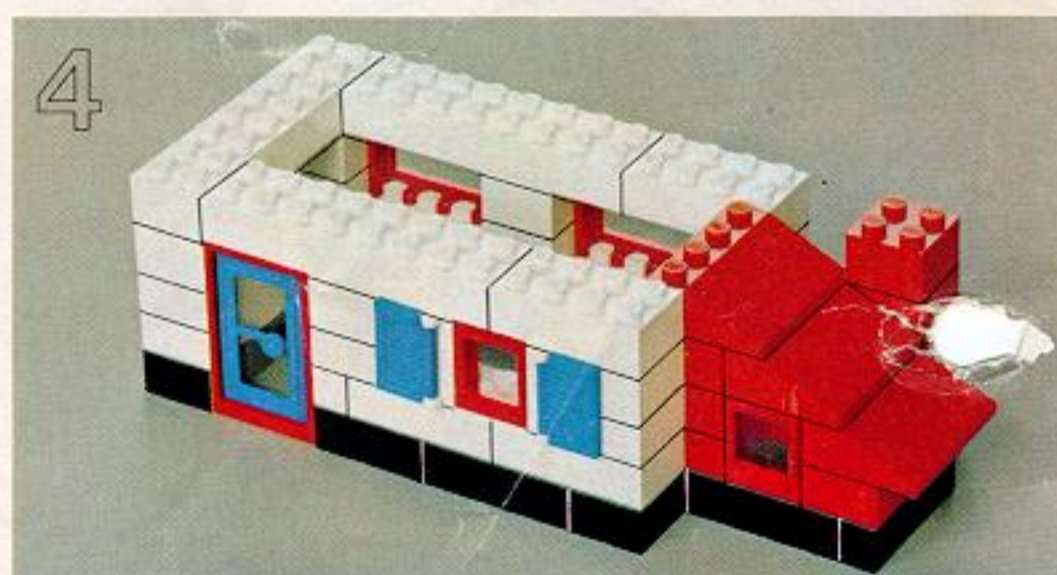
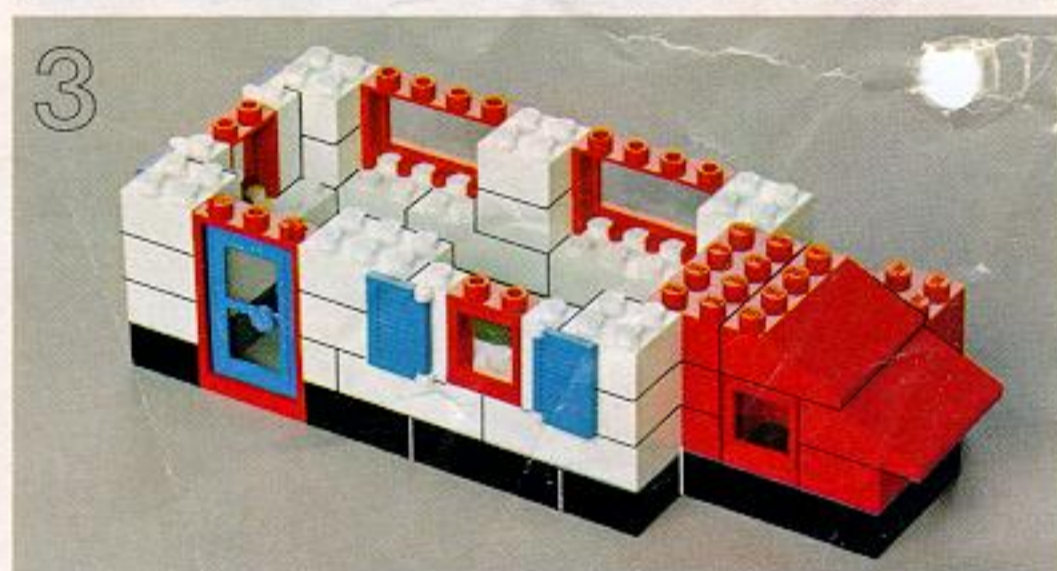
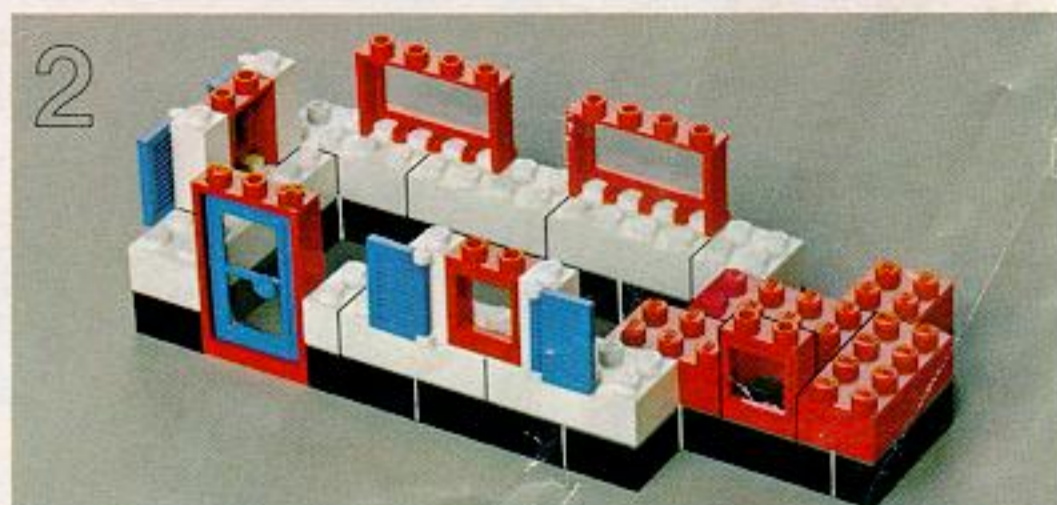
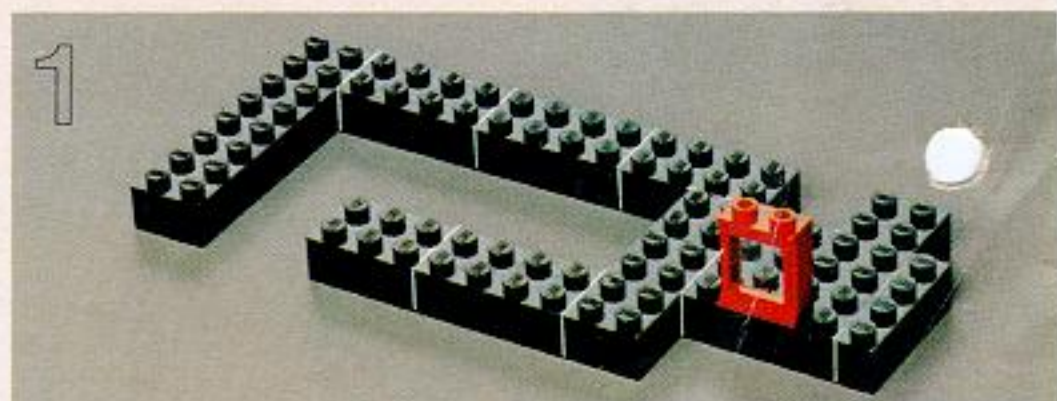
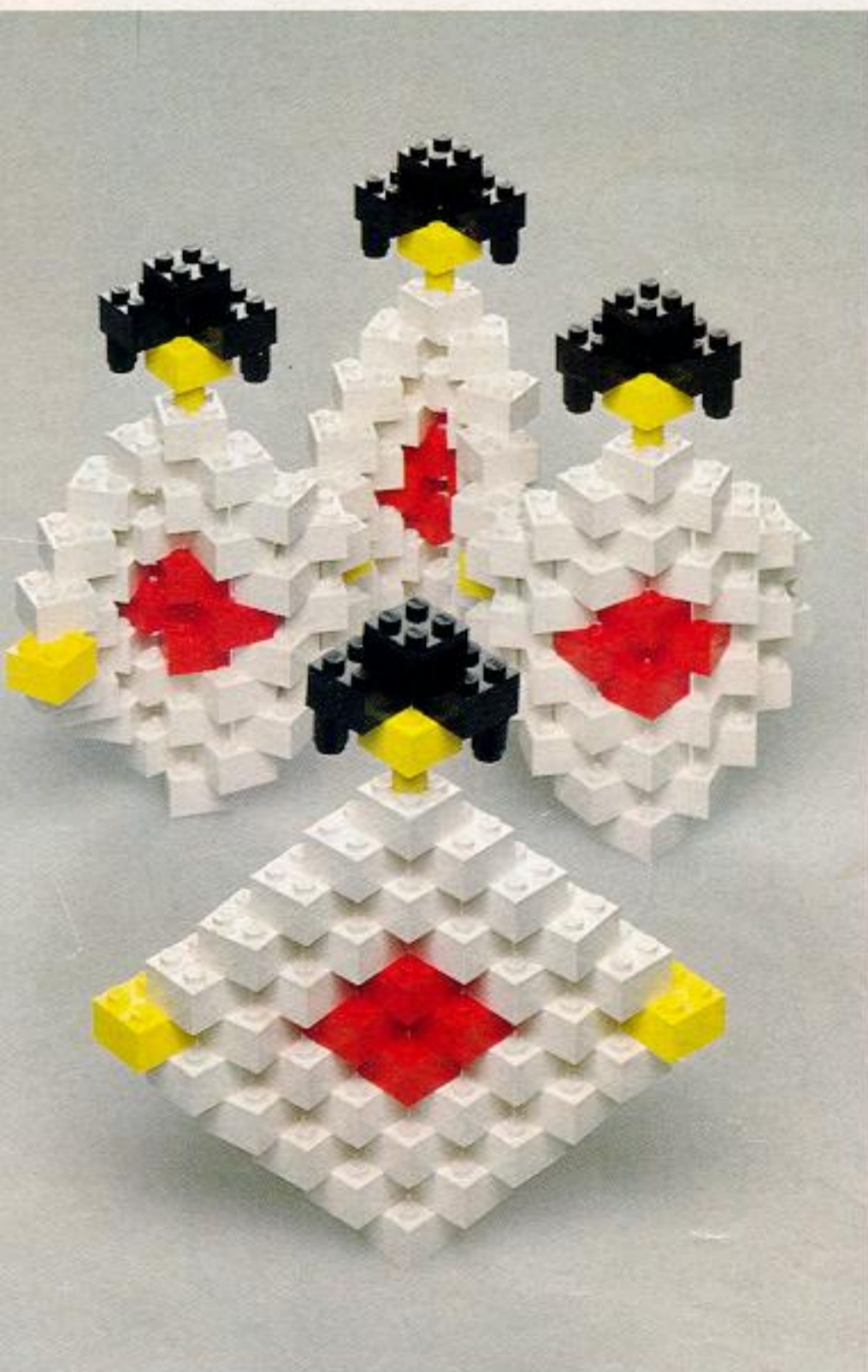
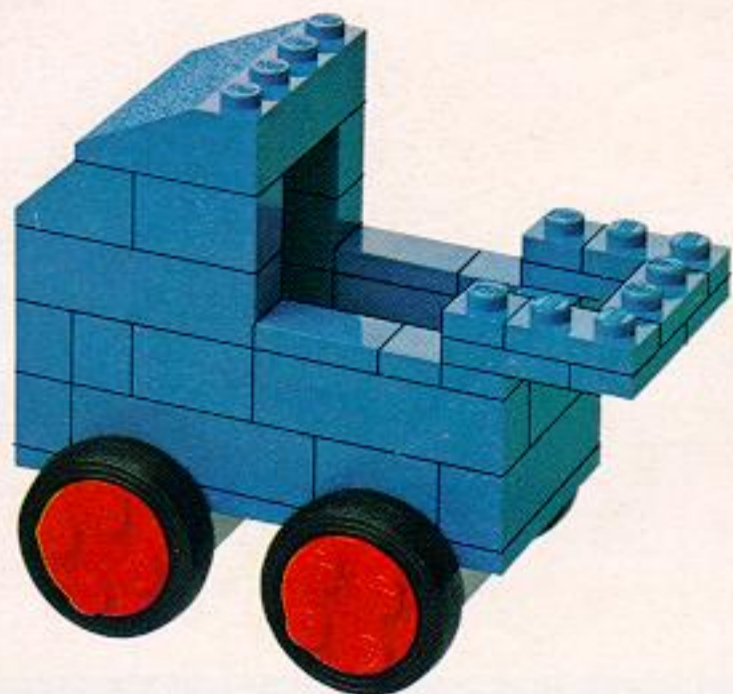

6

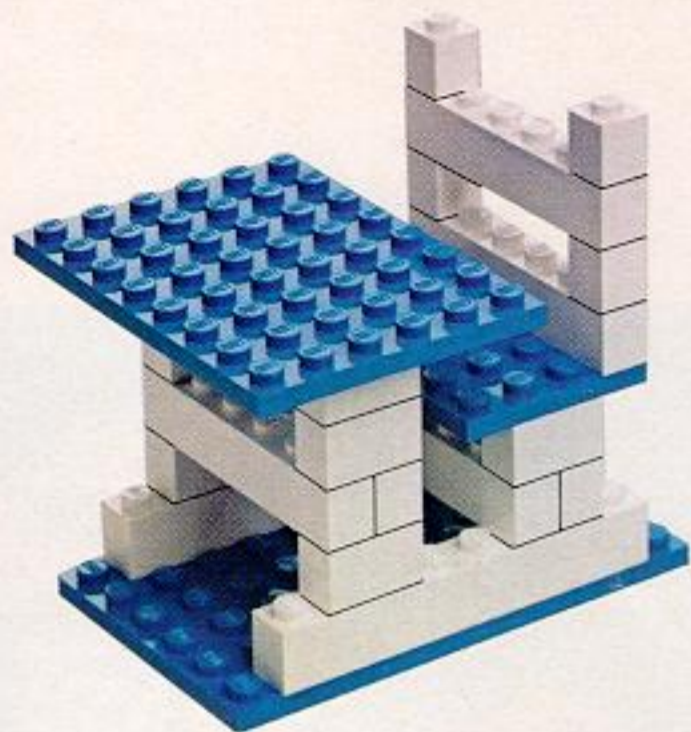
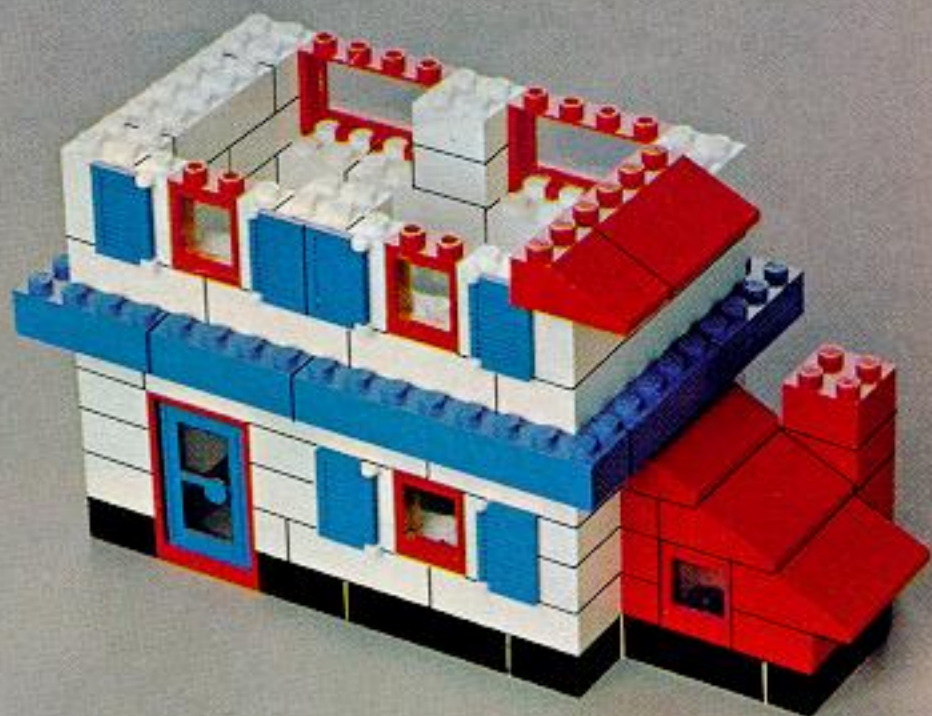

7

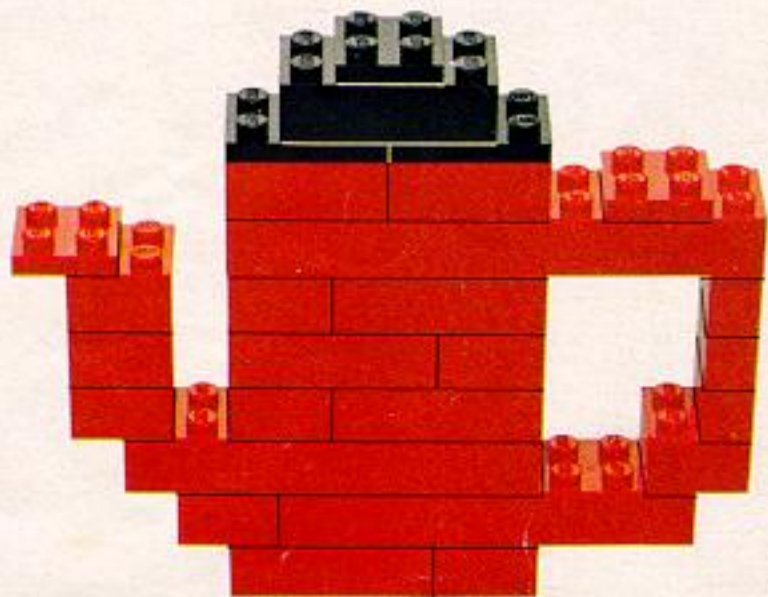
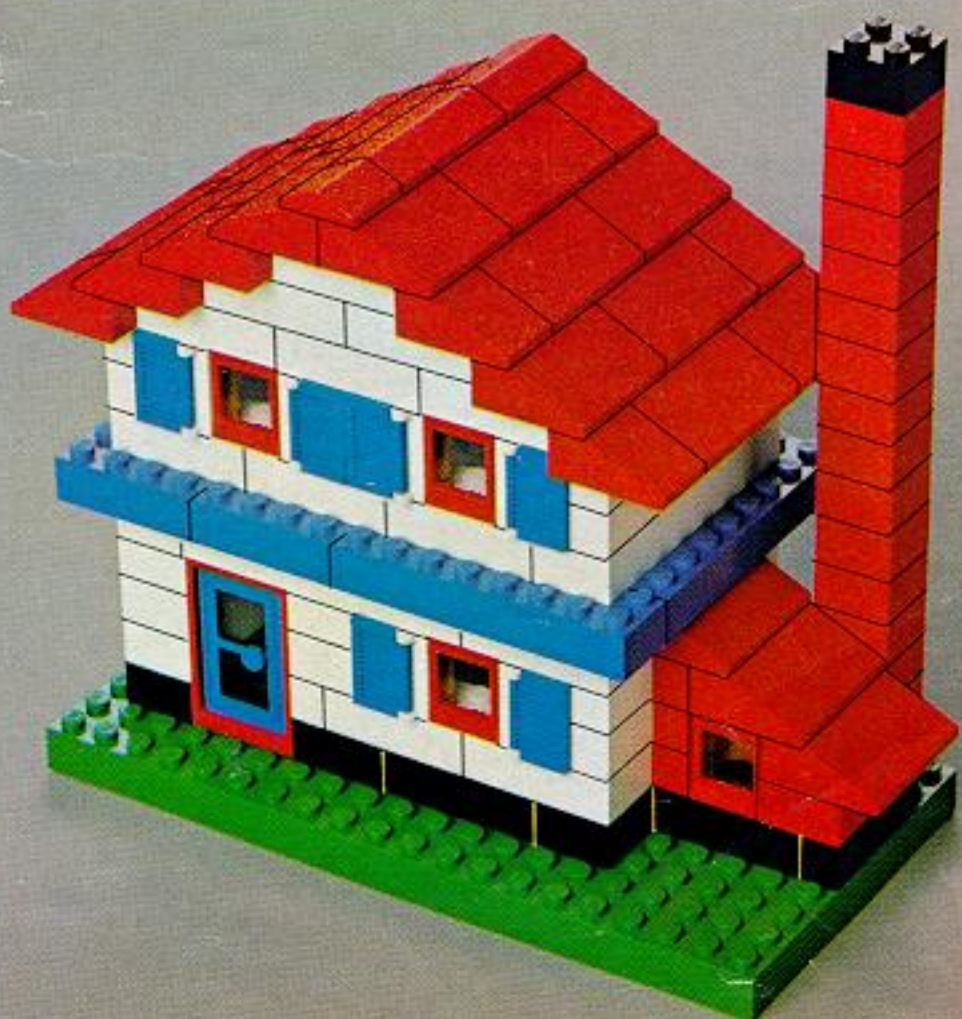
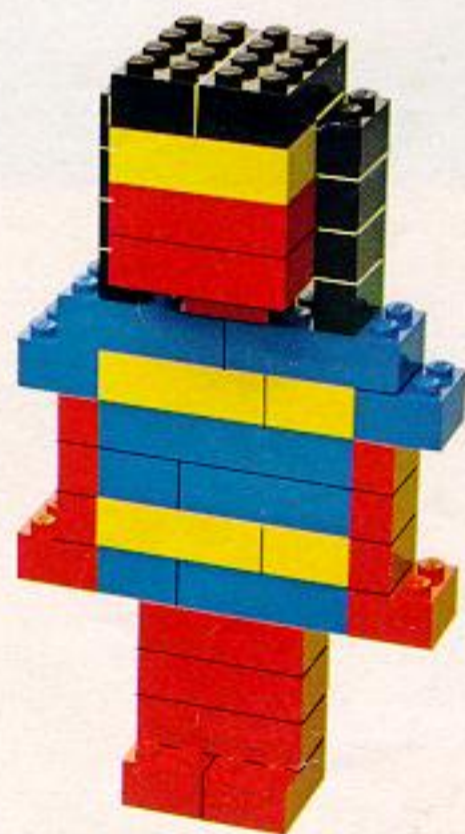
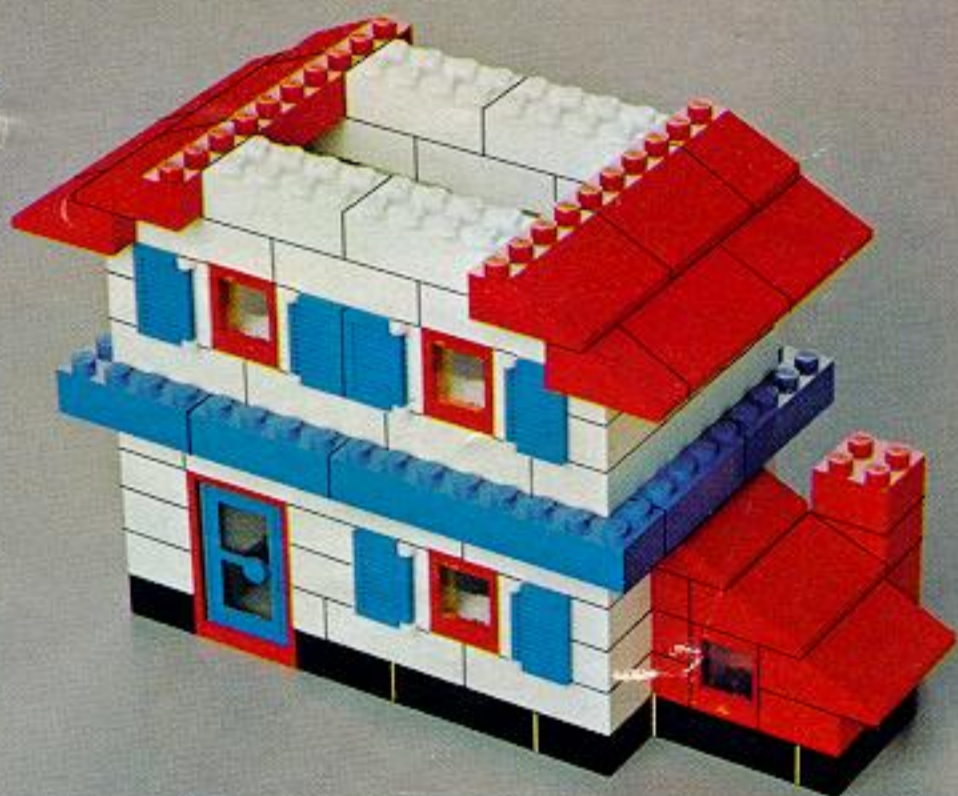

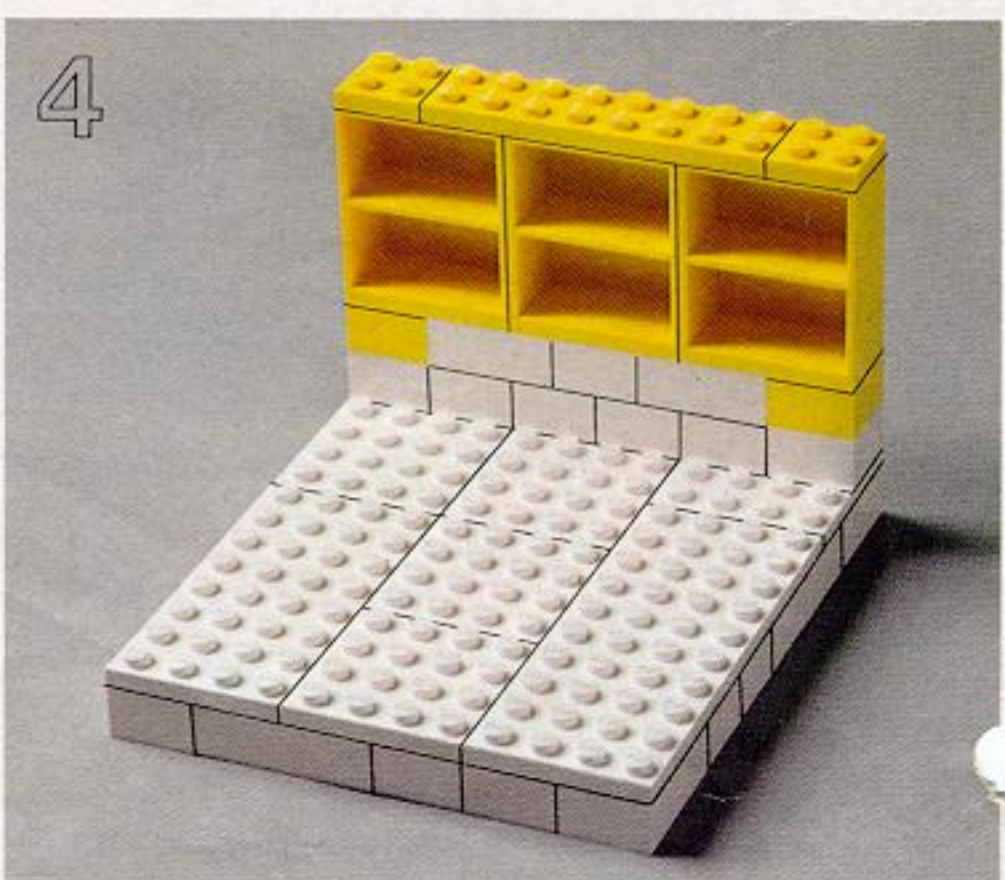
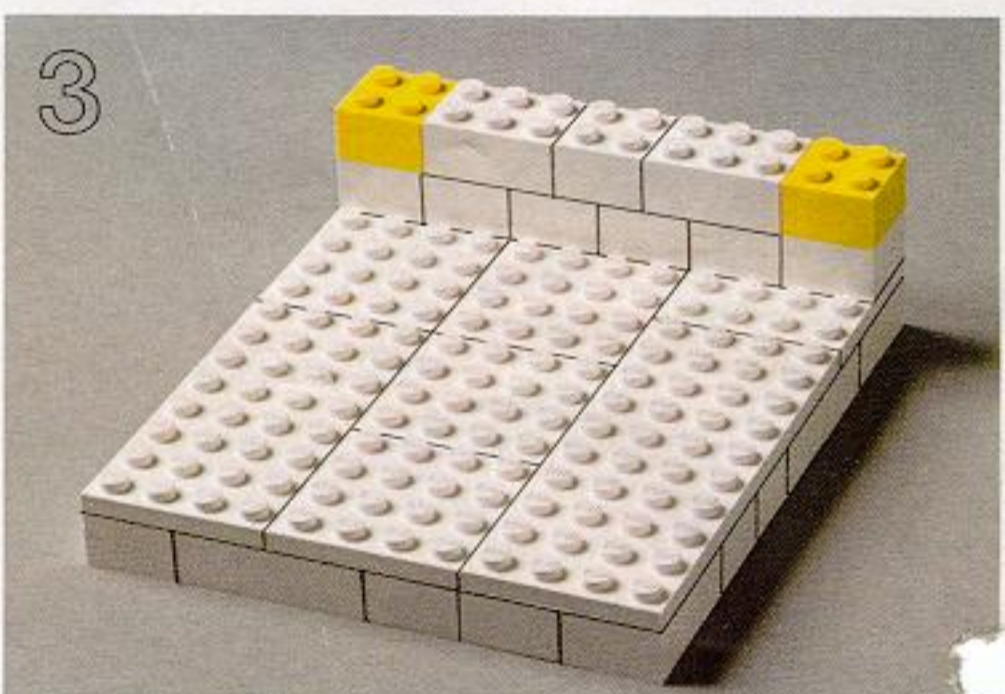
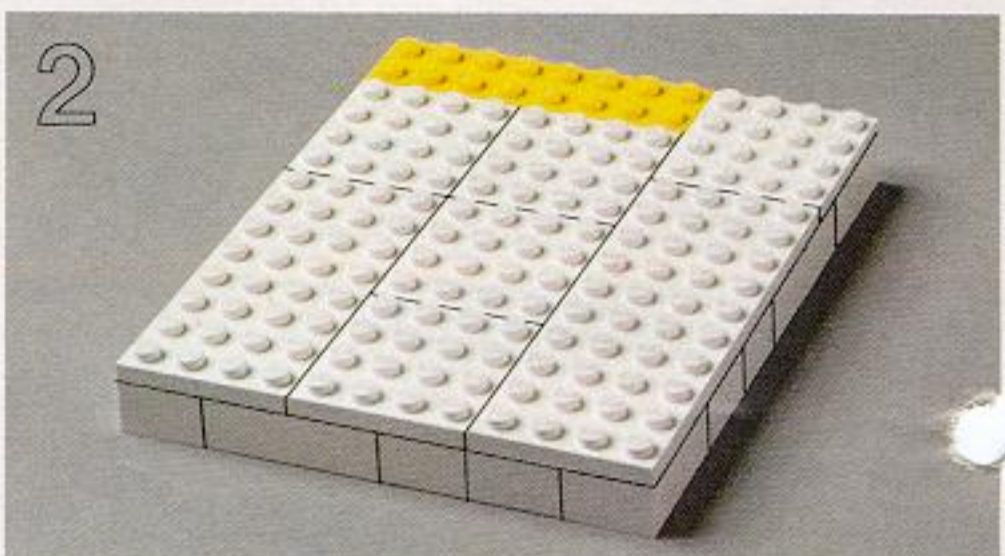
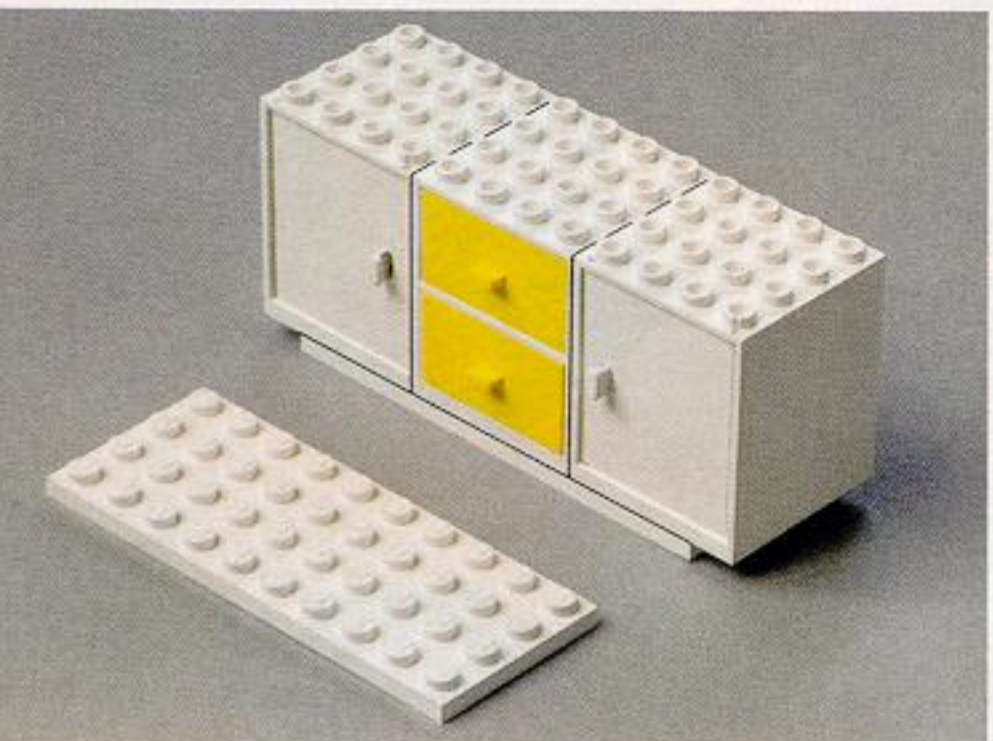
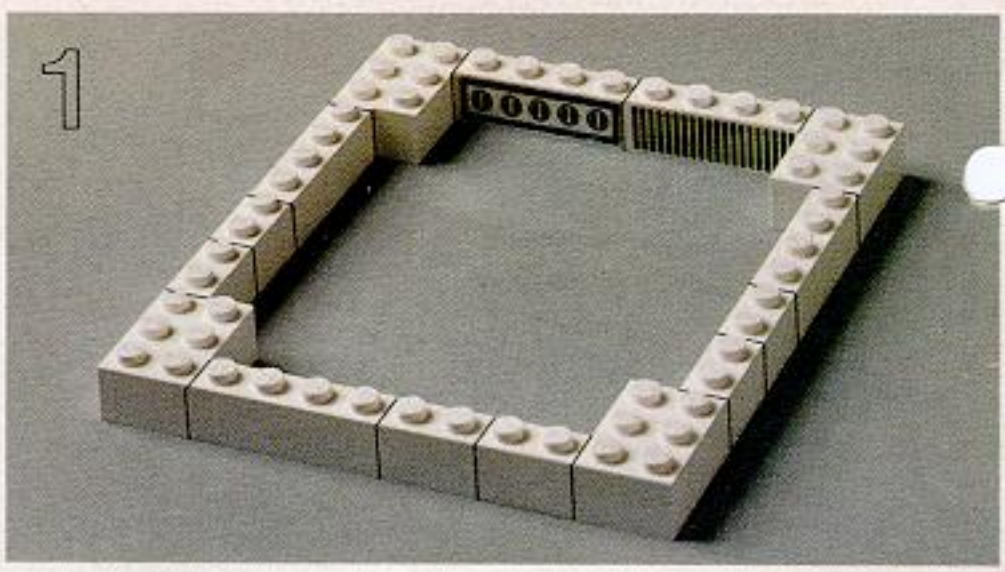

31

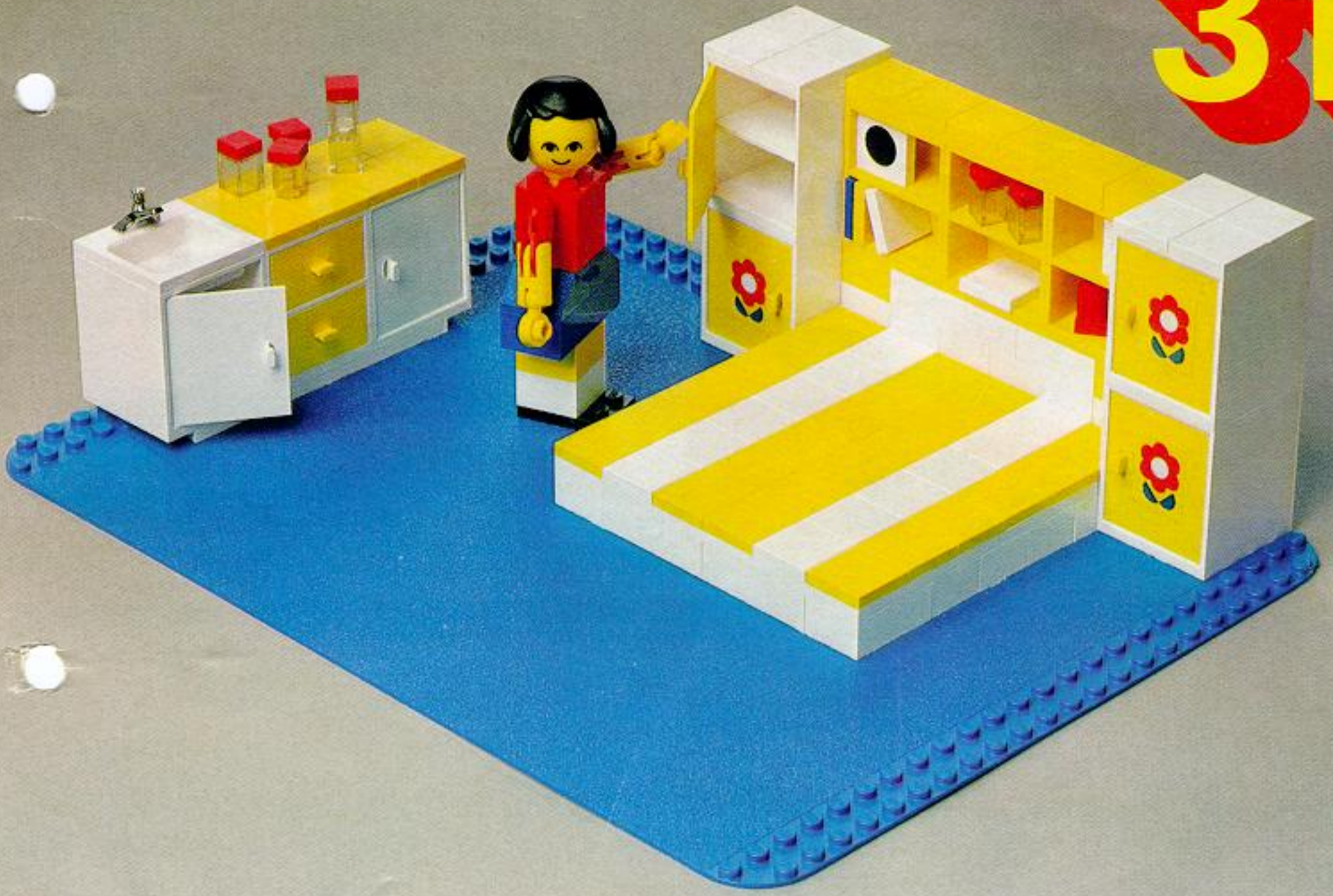

32

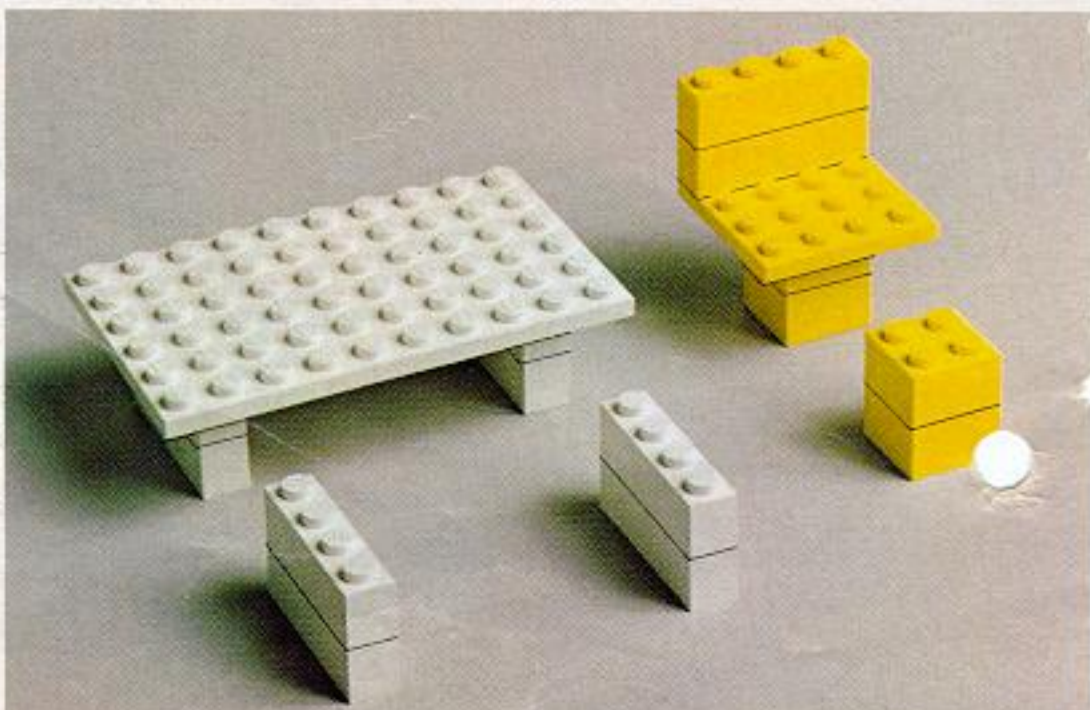
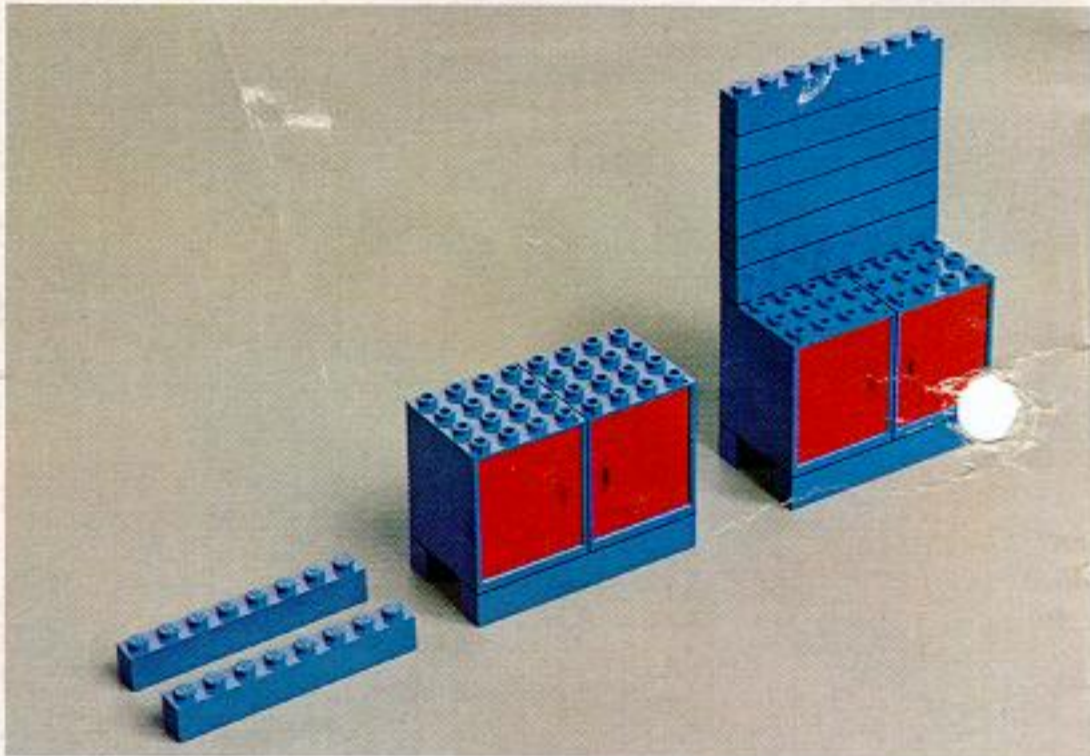
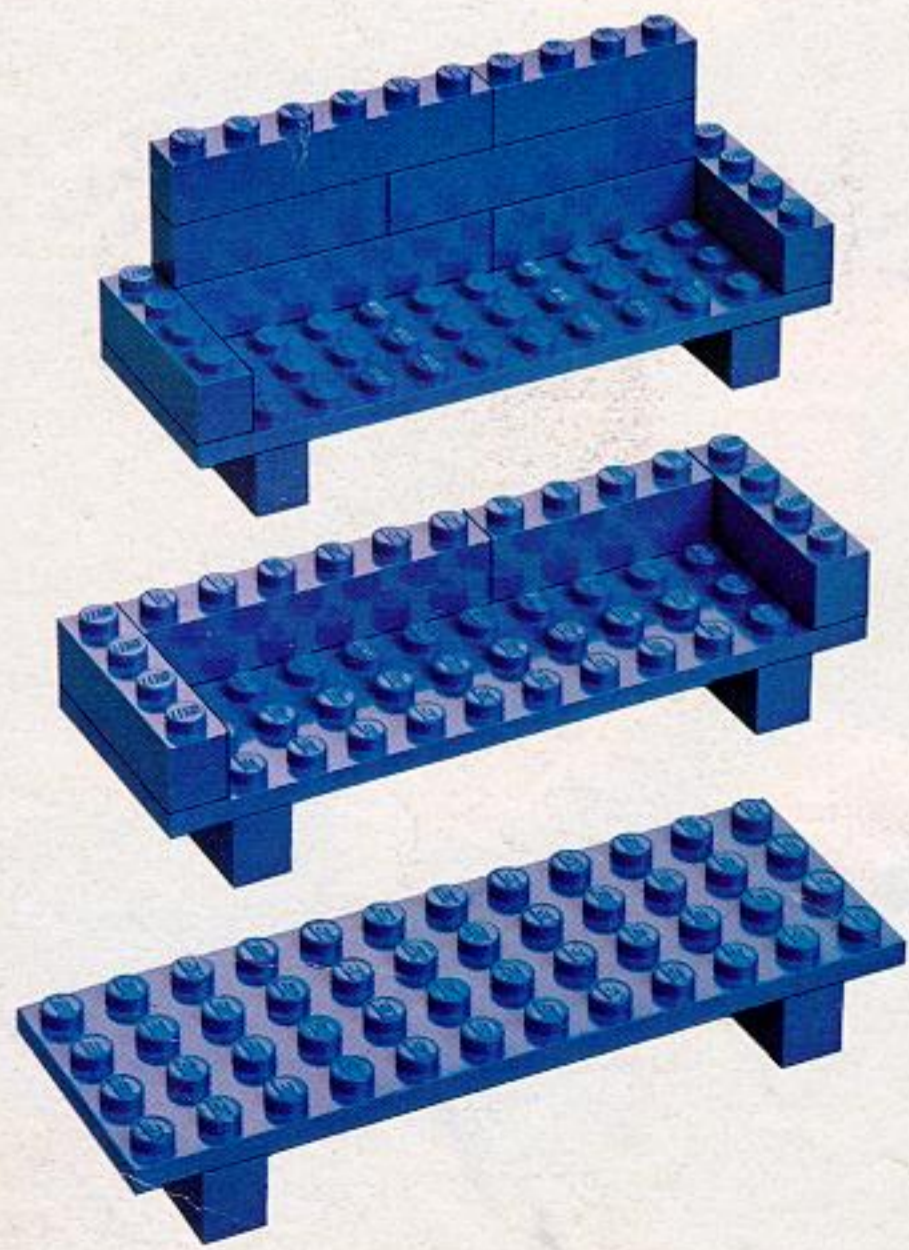

33

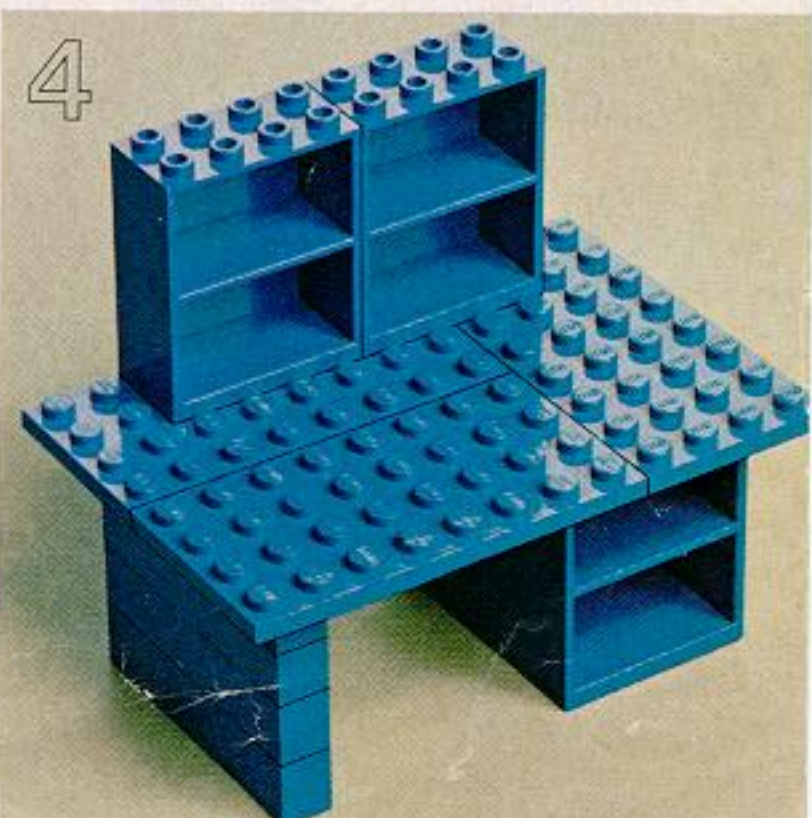
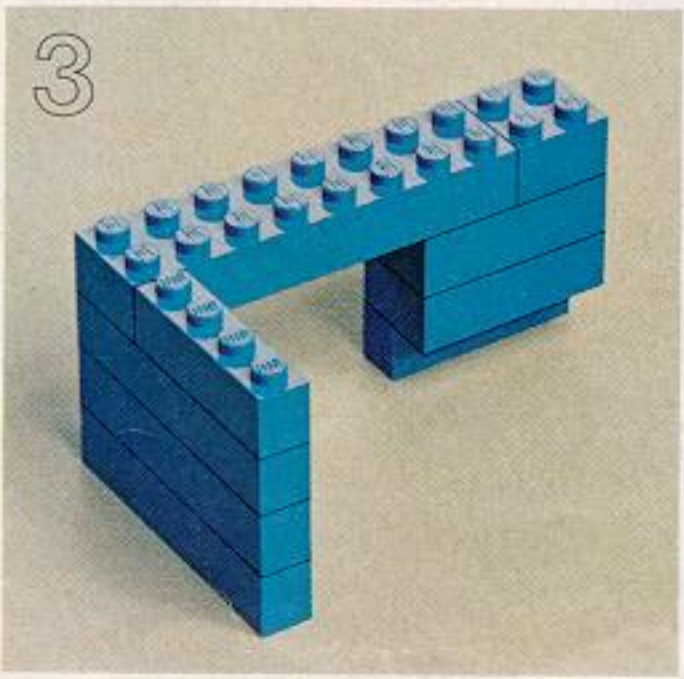
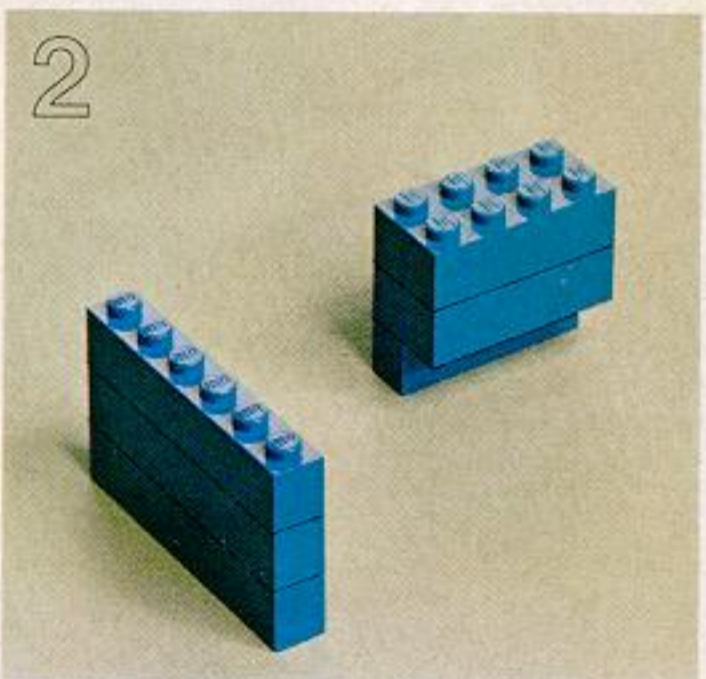
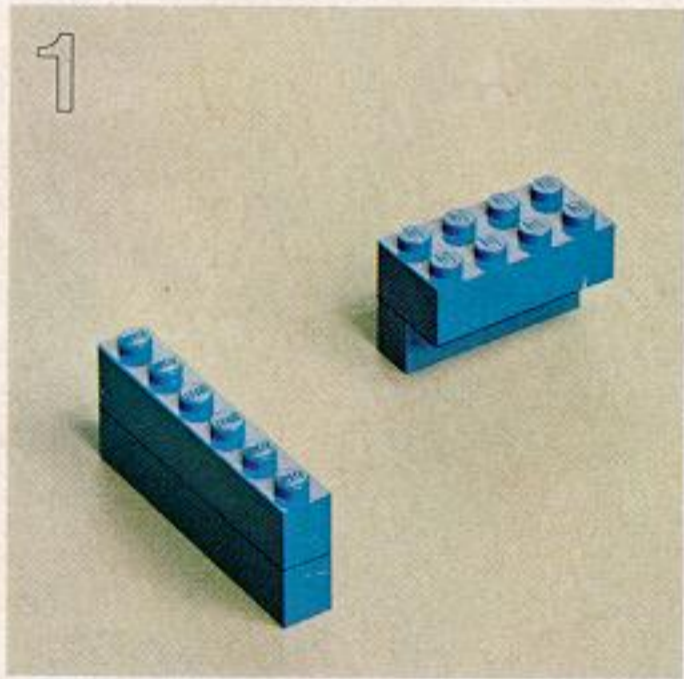
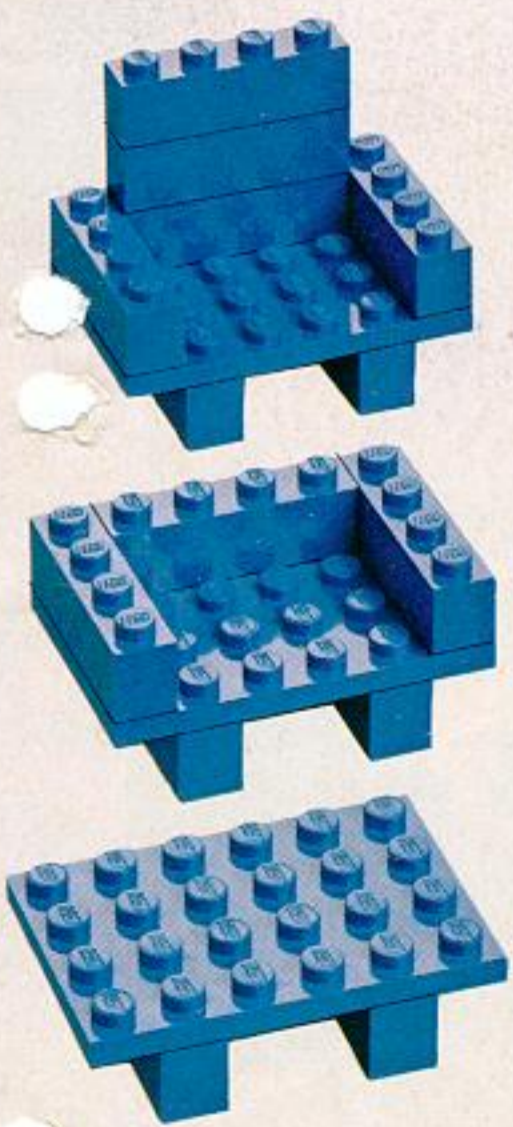

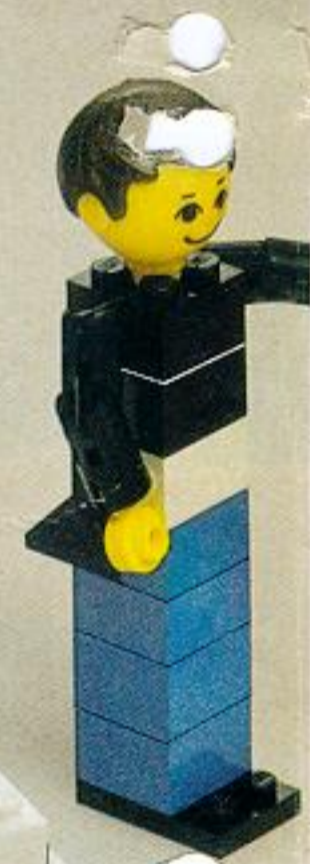
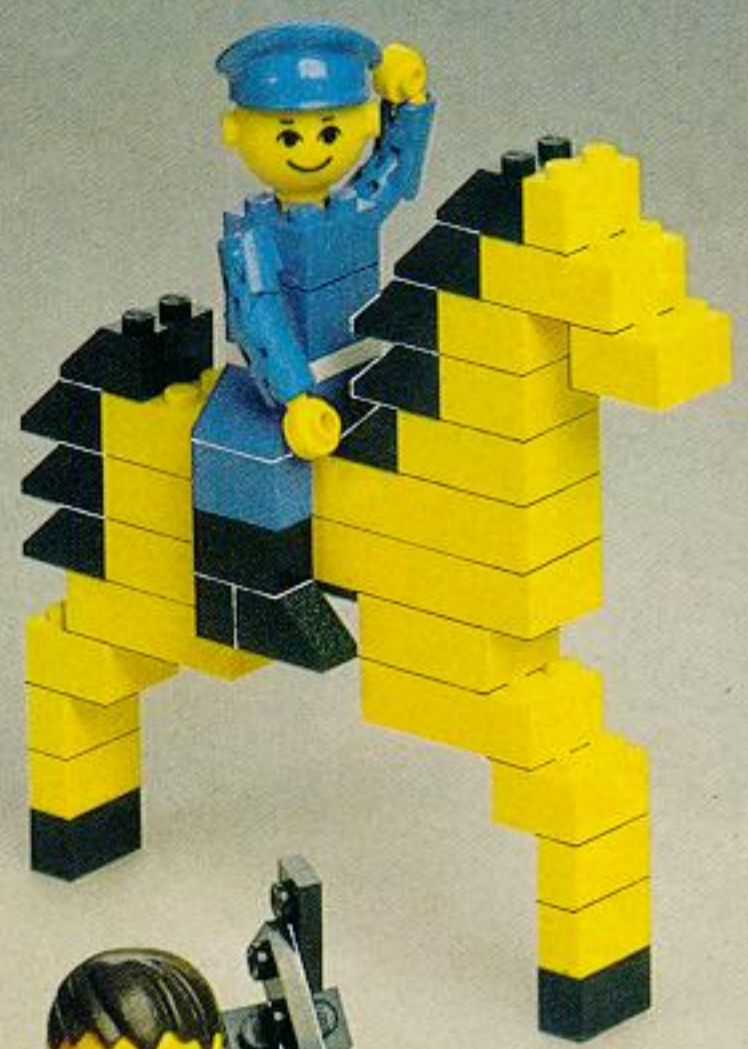
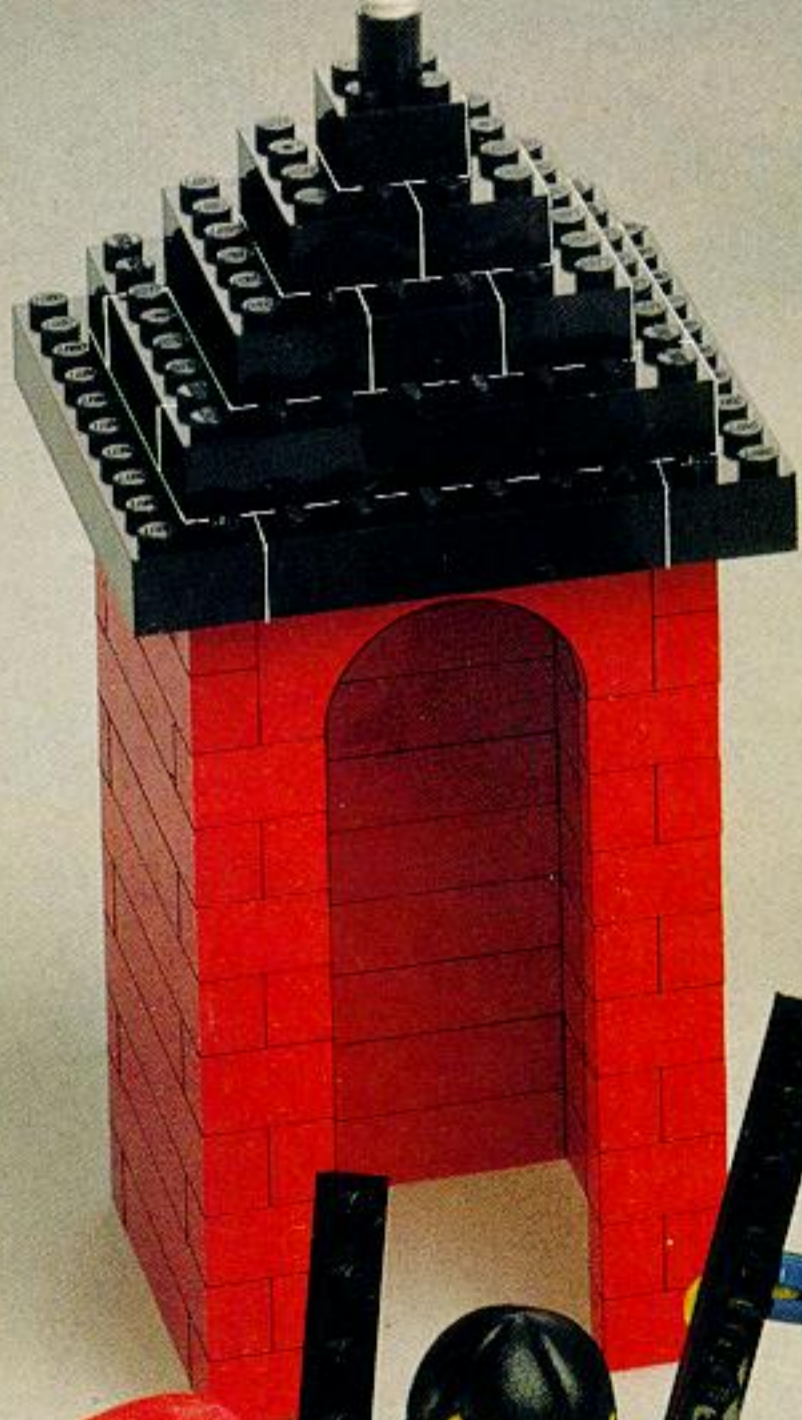

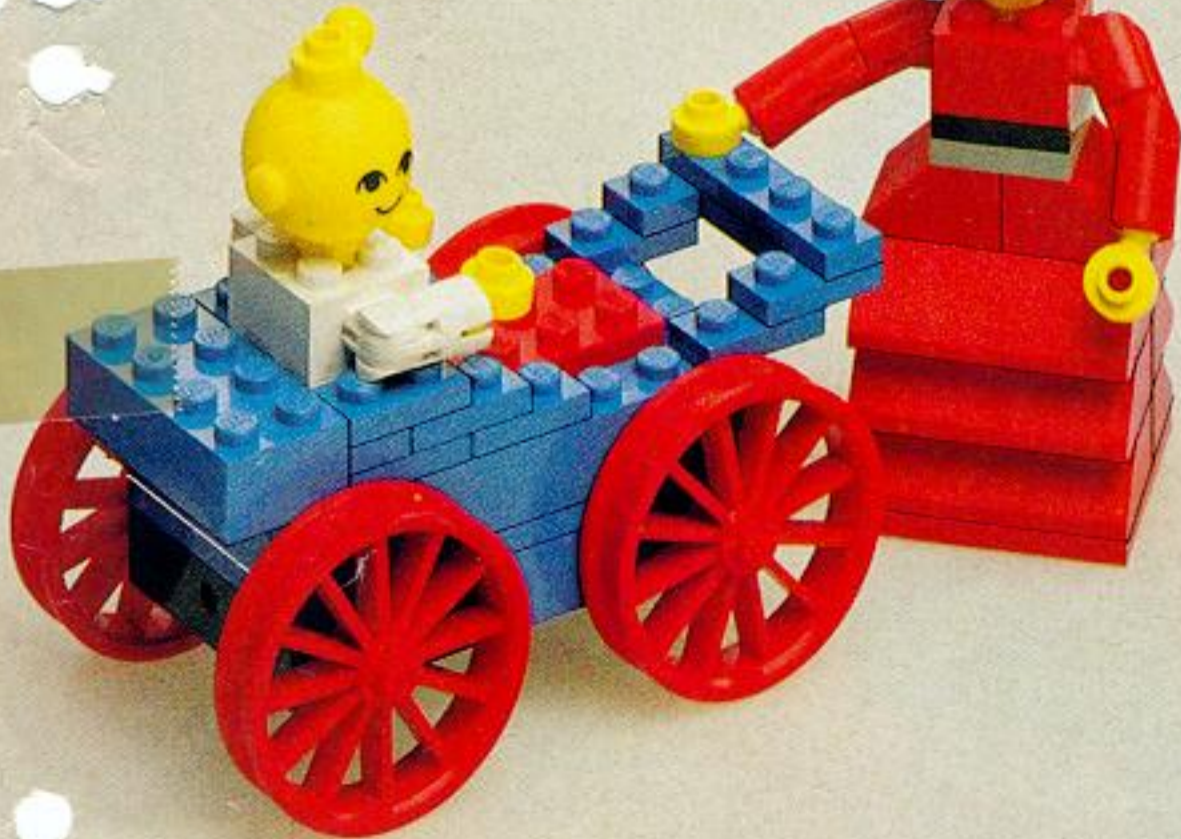
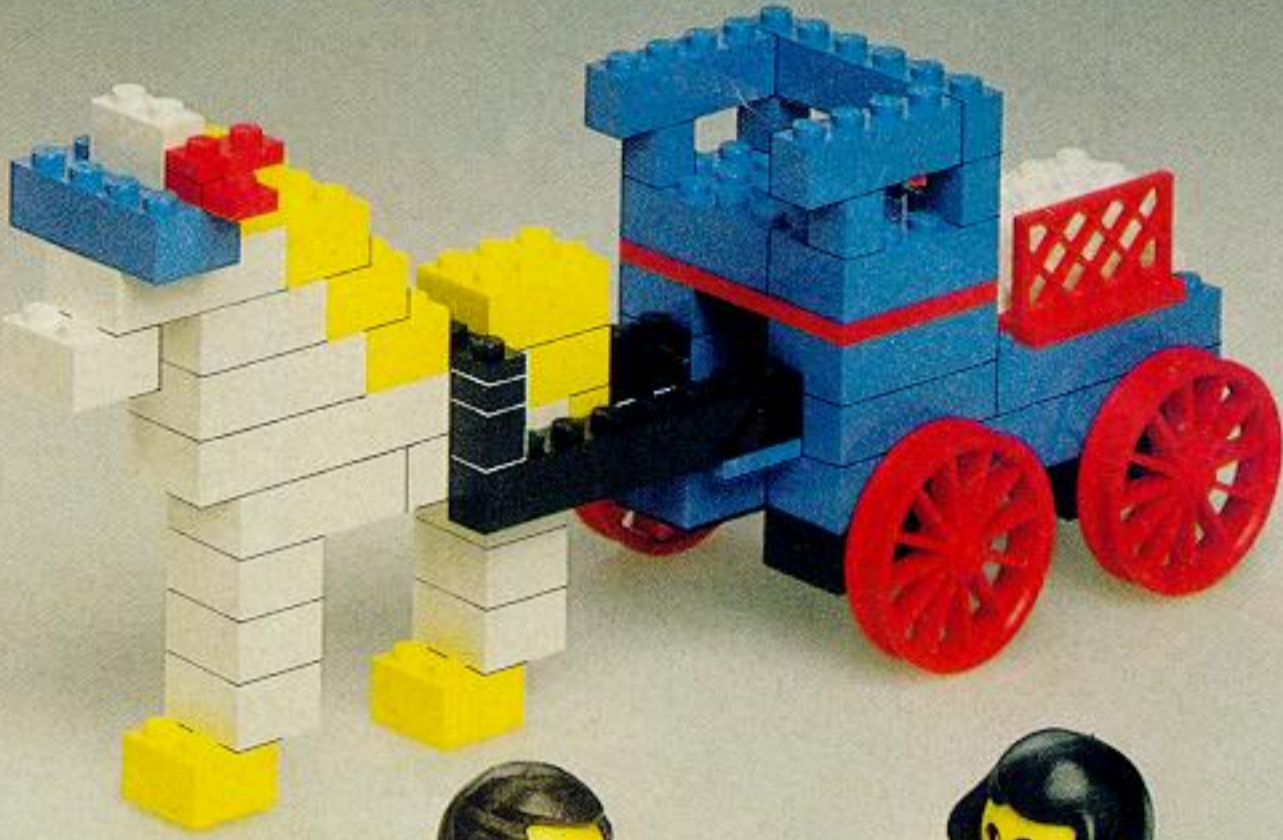

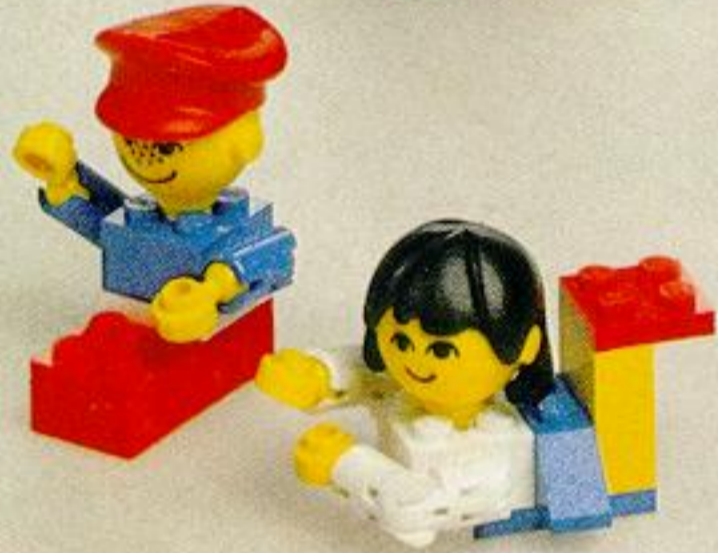



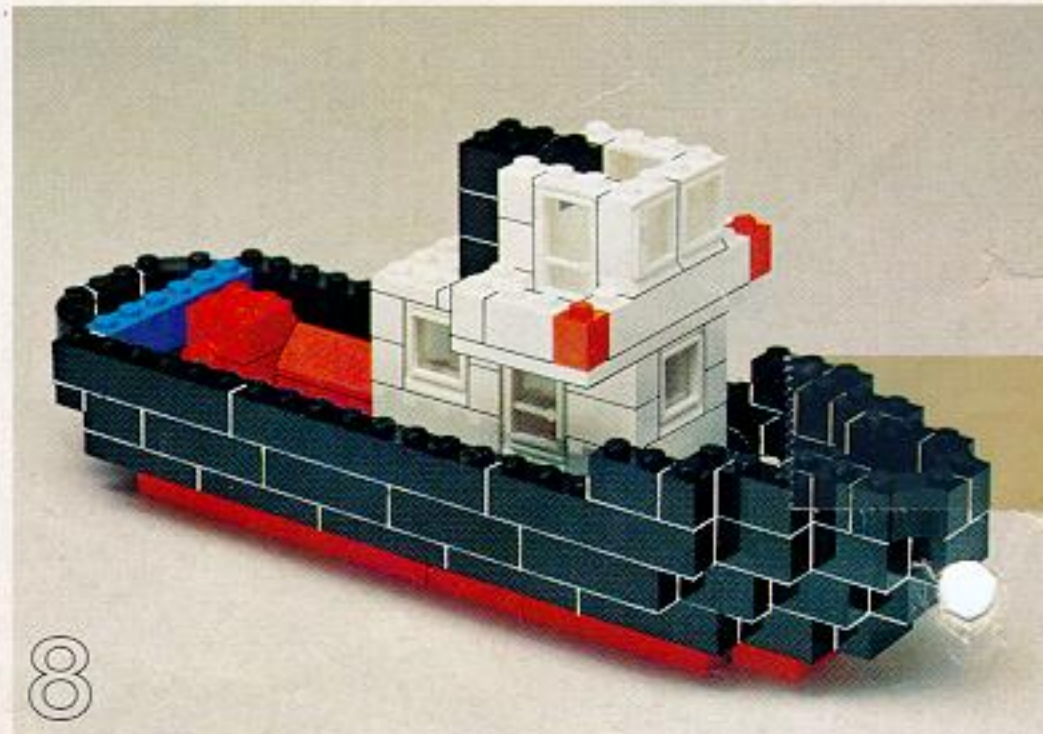
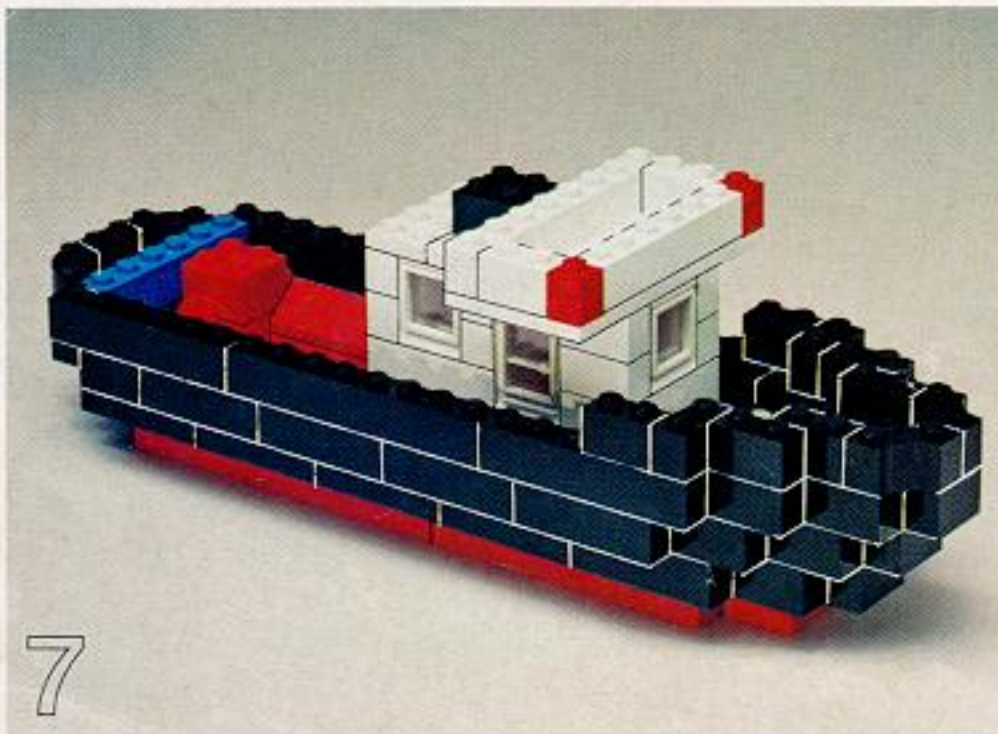
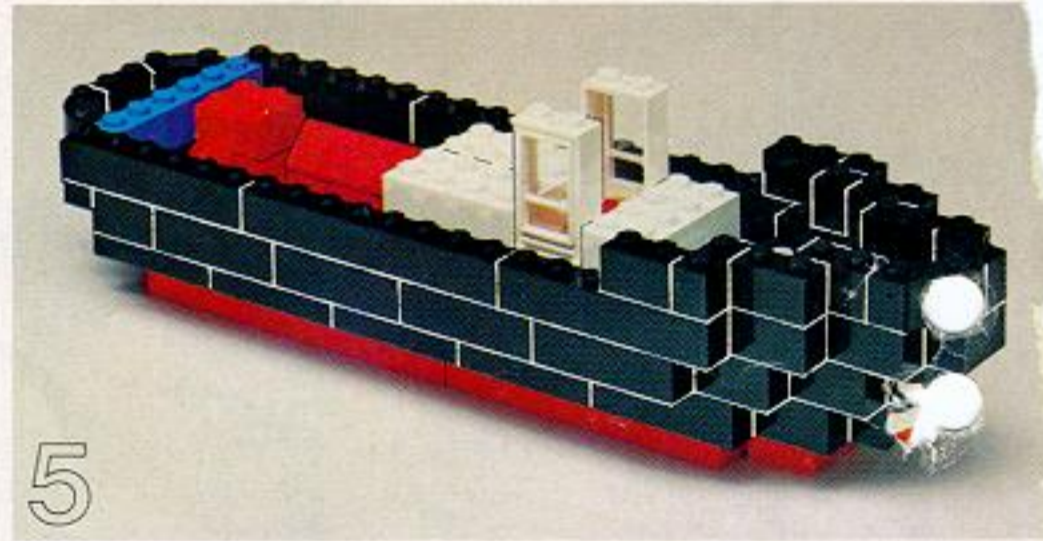
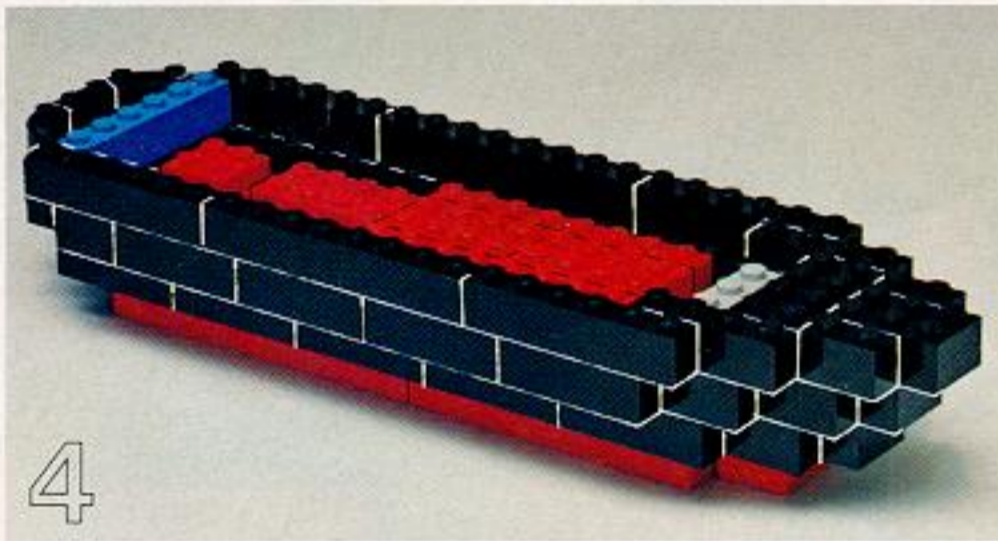
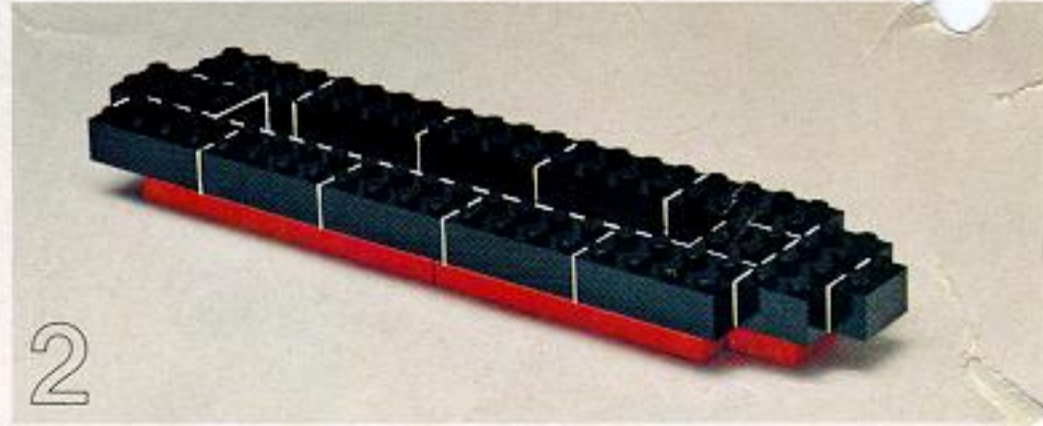
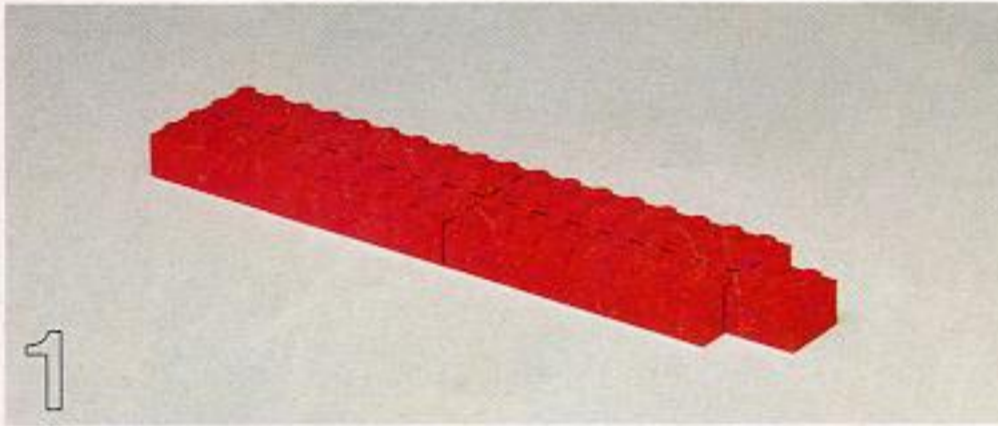
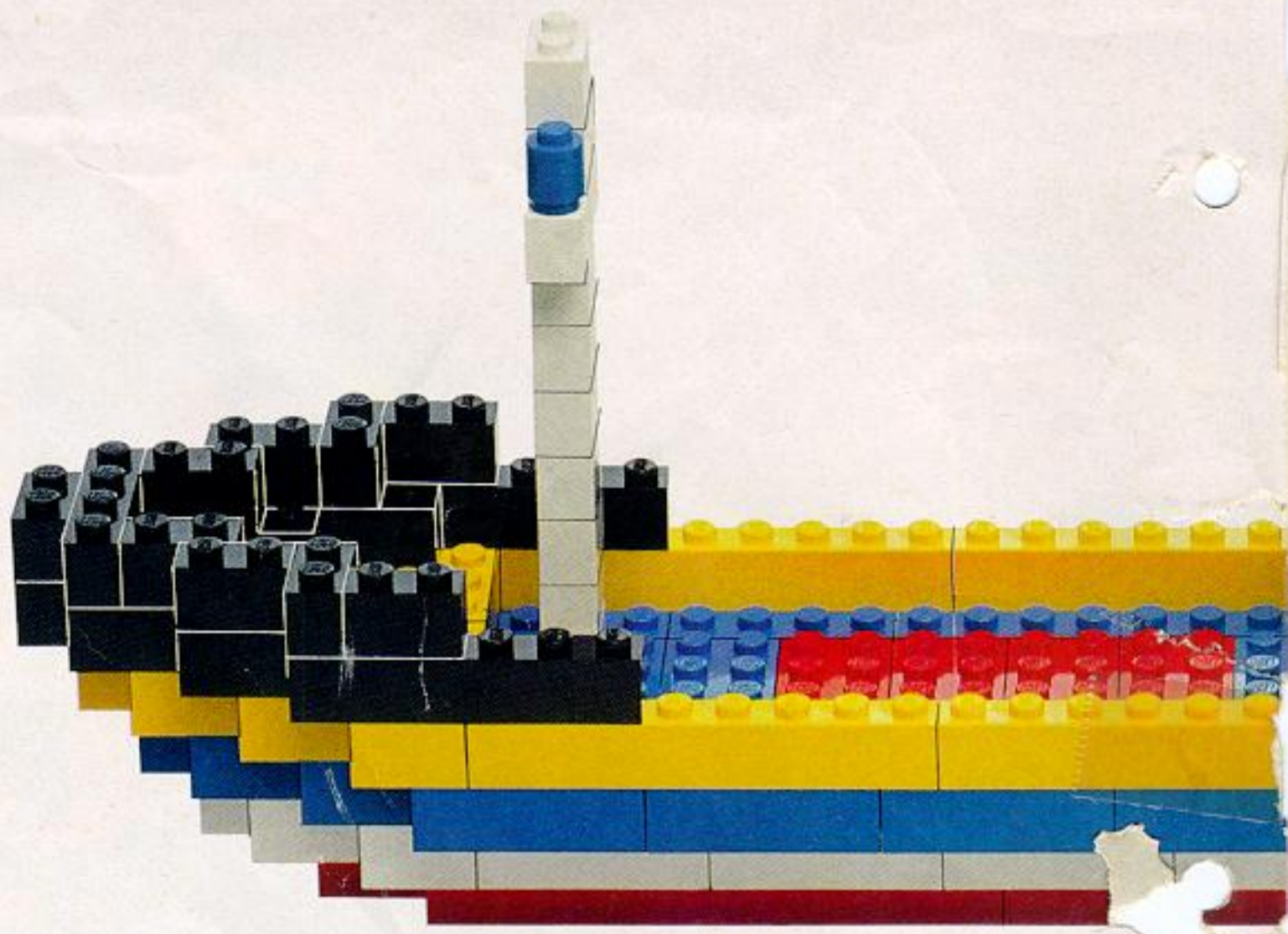

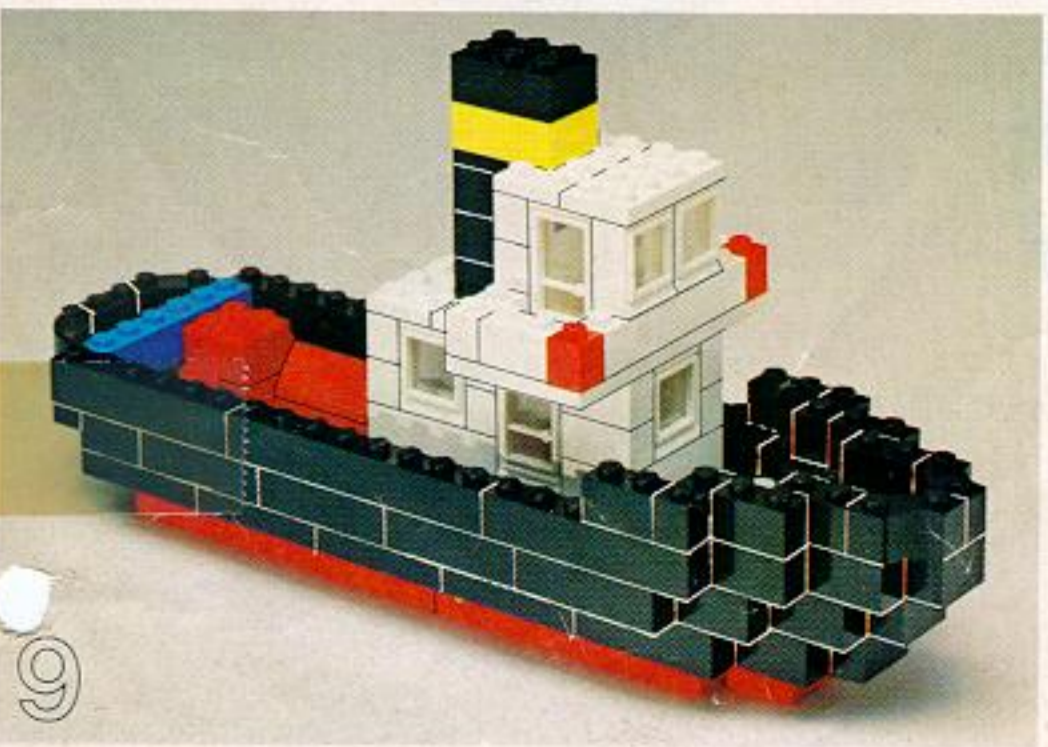
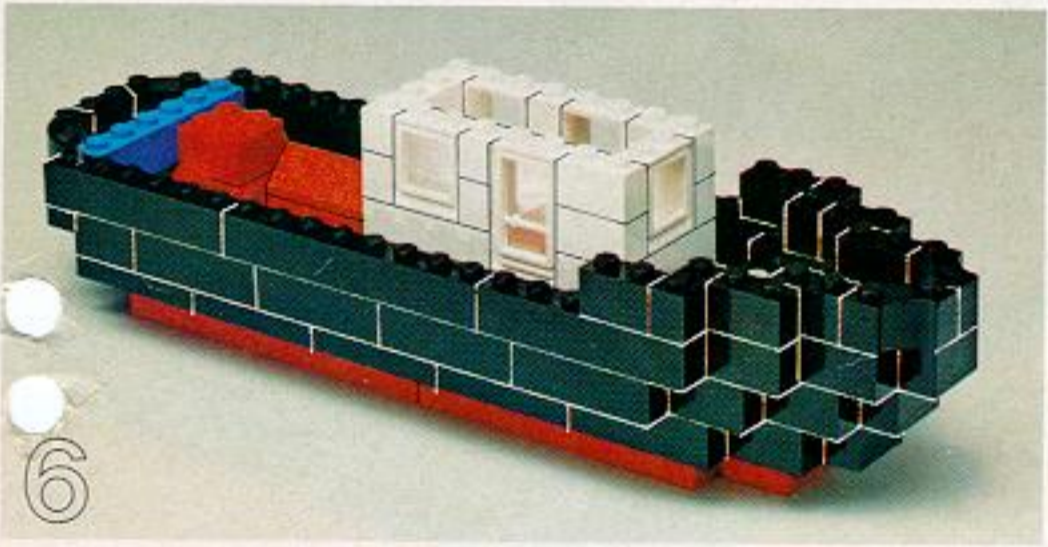
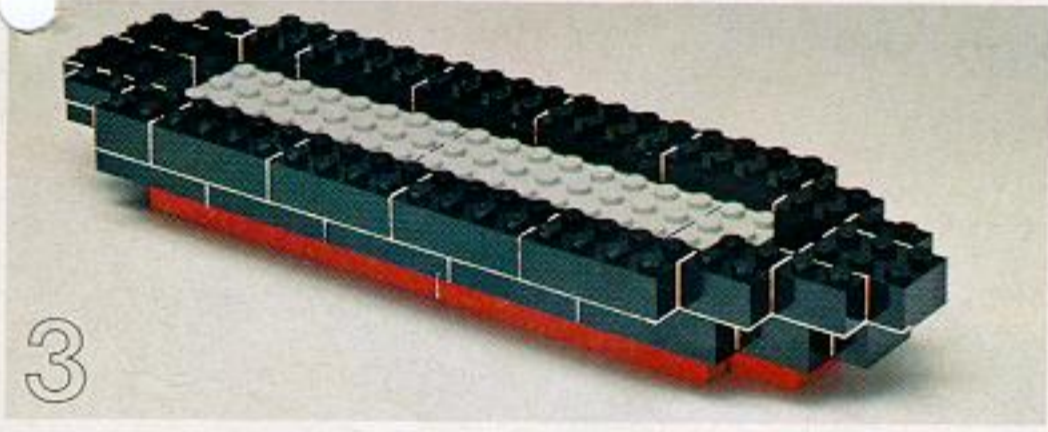
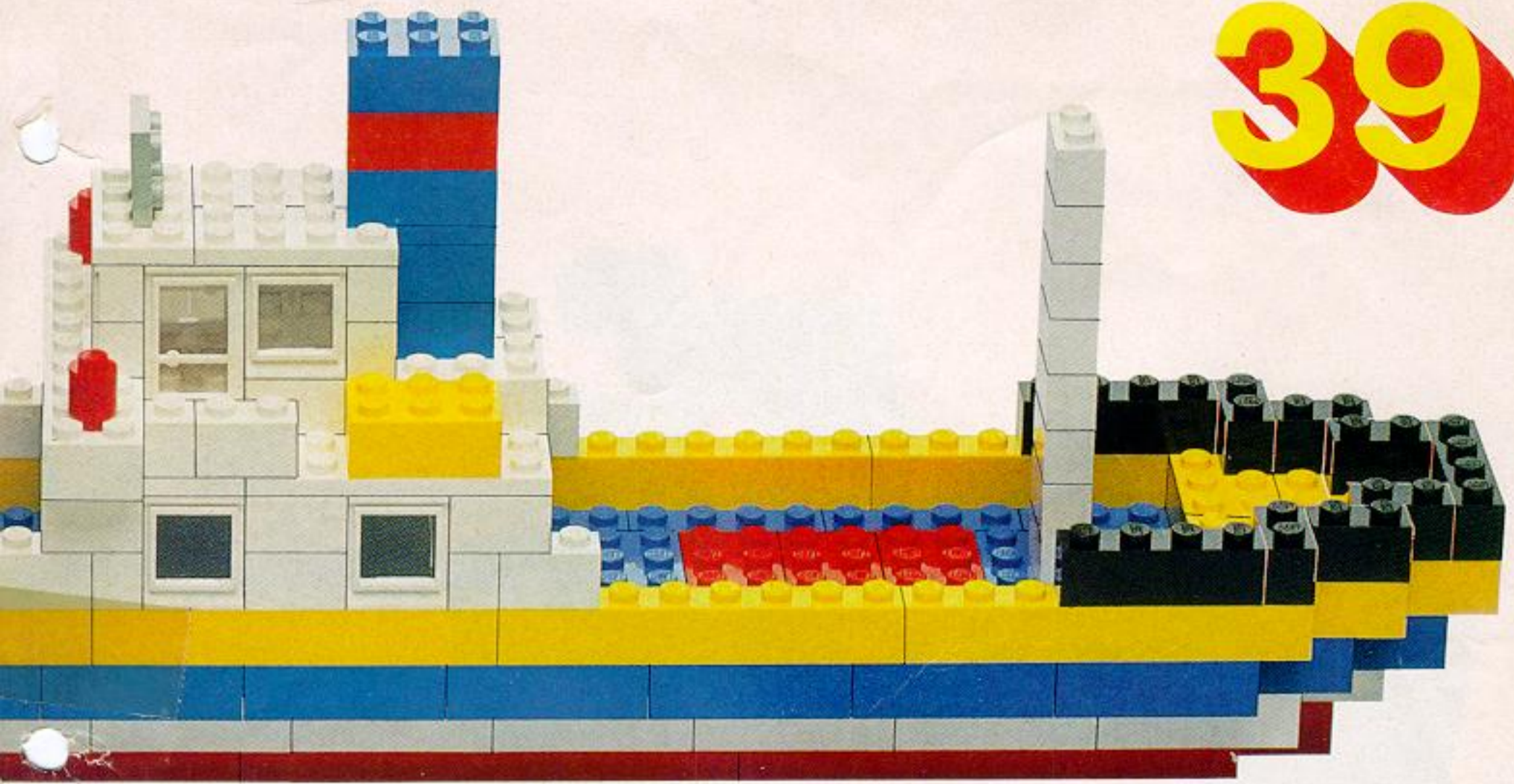

40

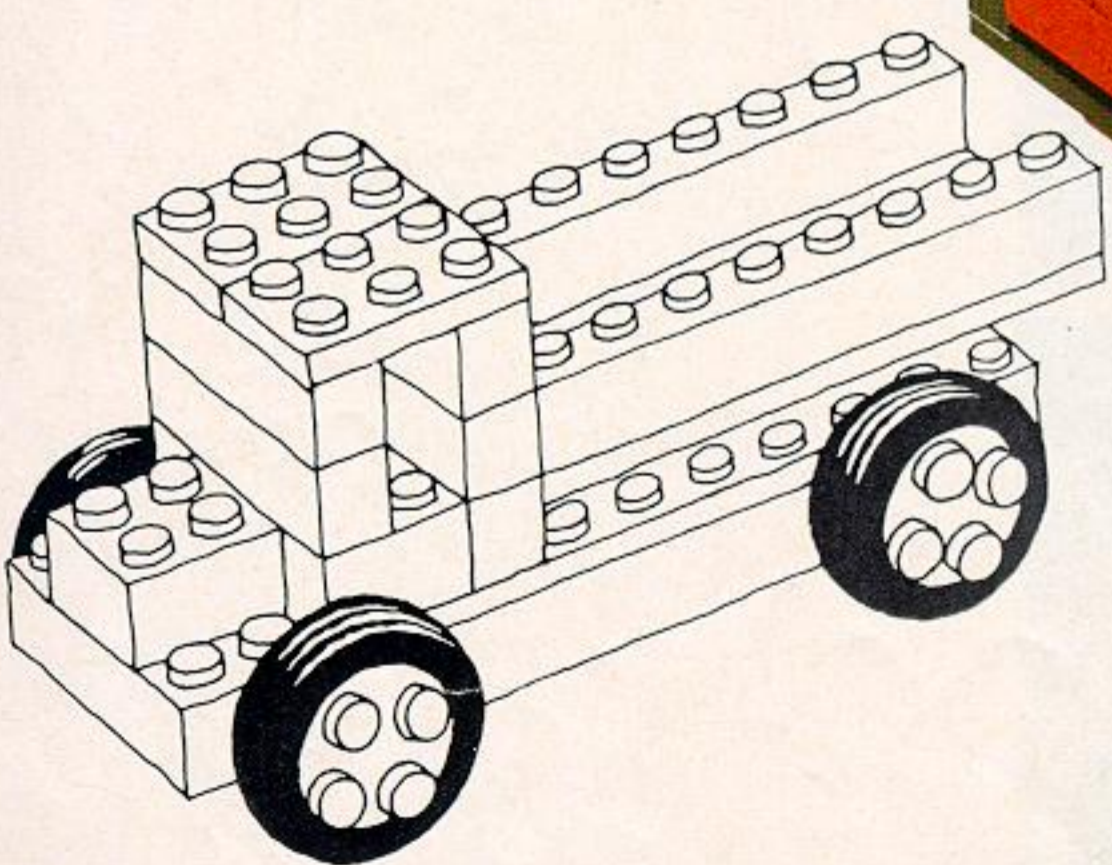
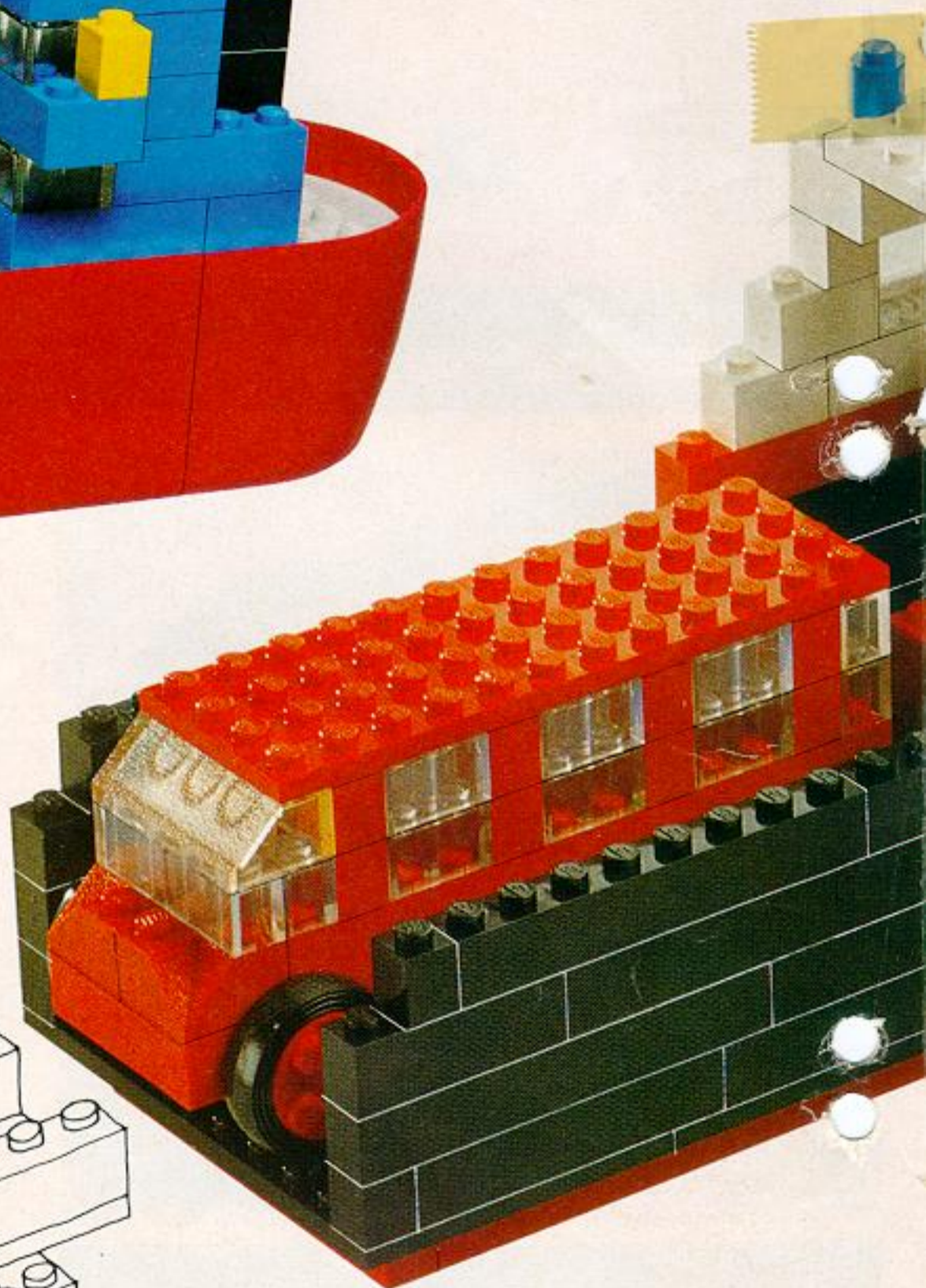
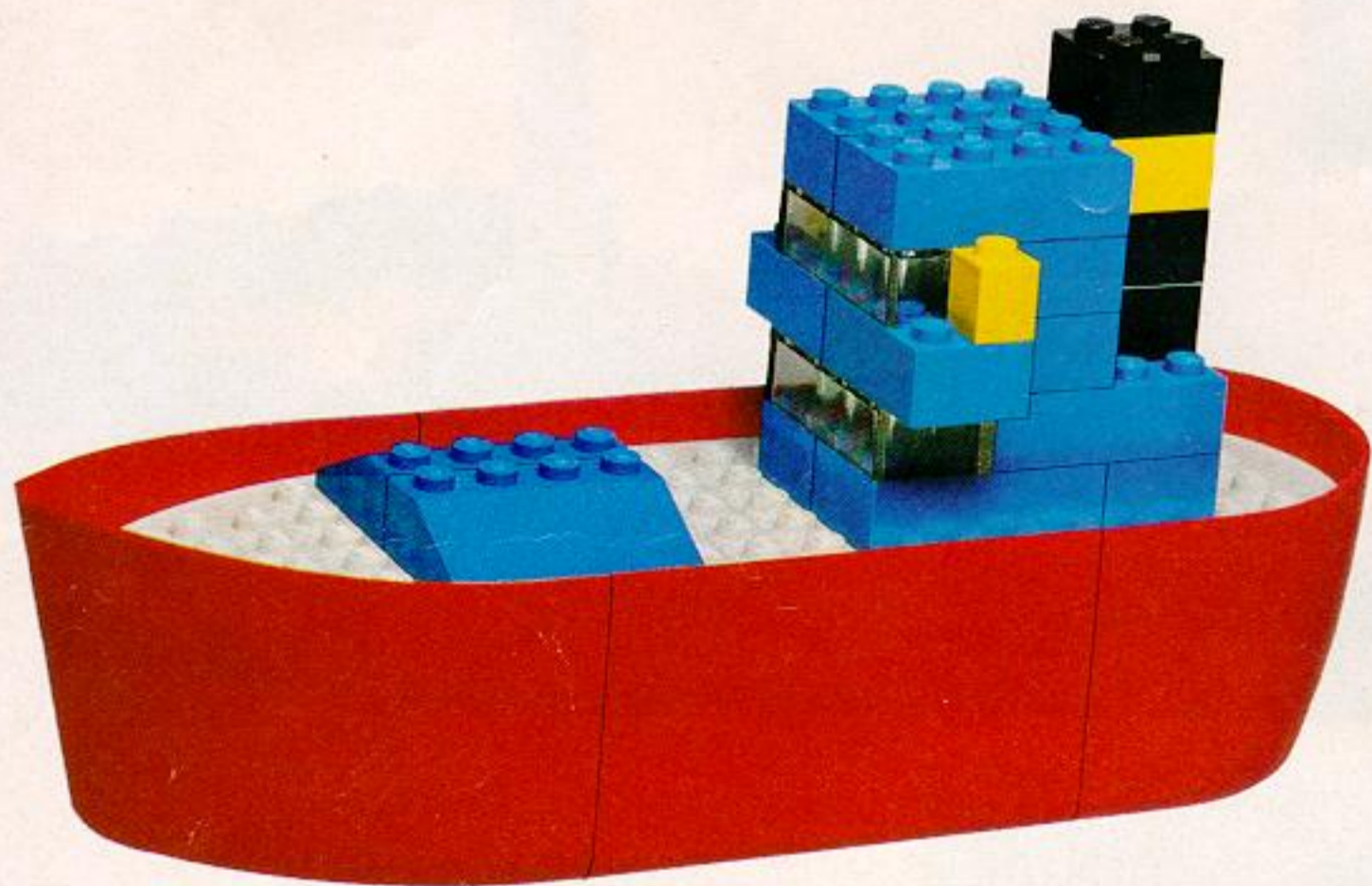

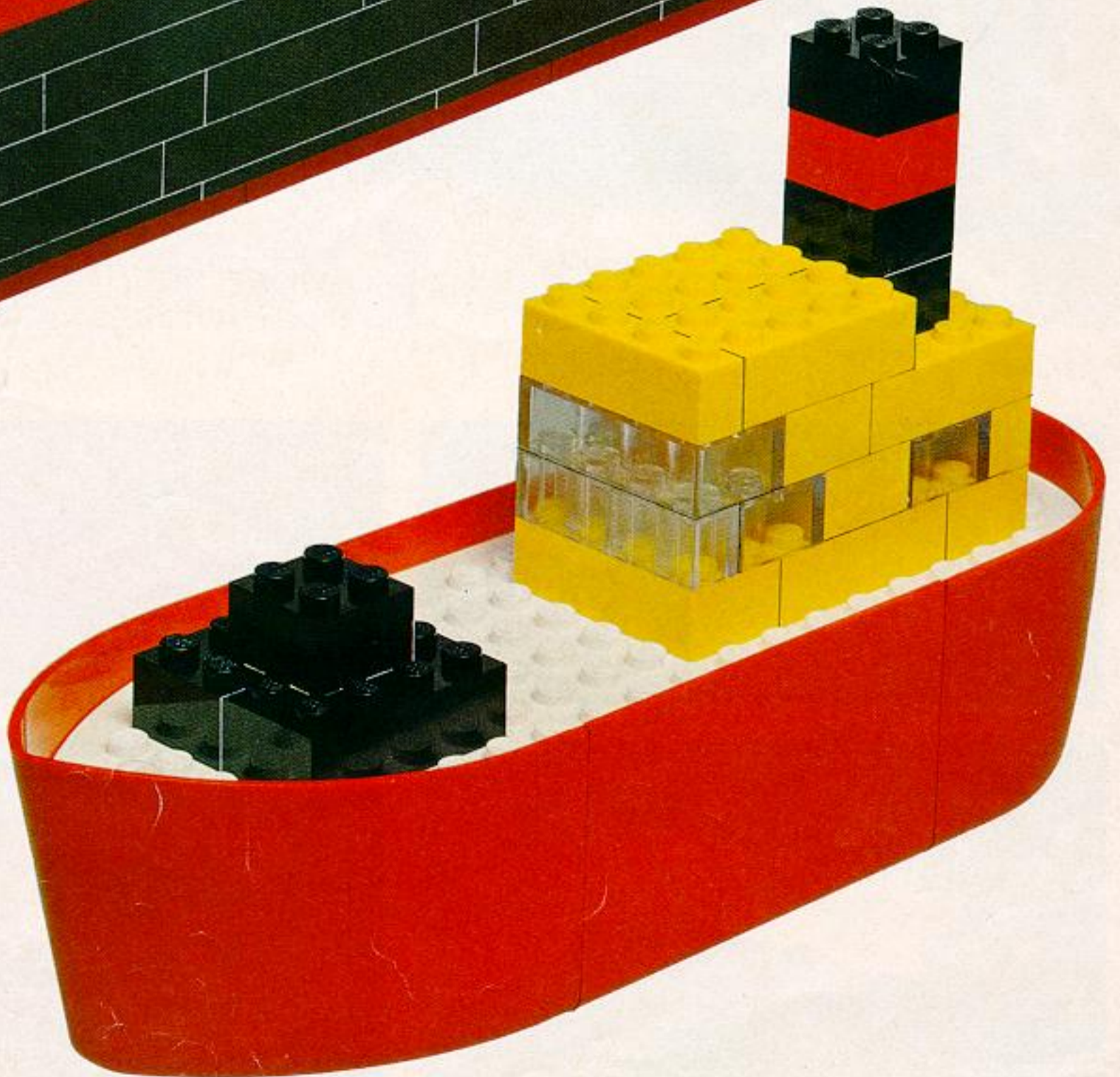
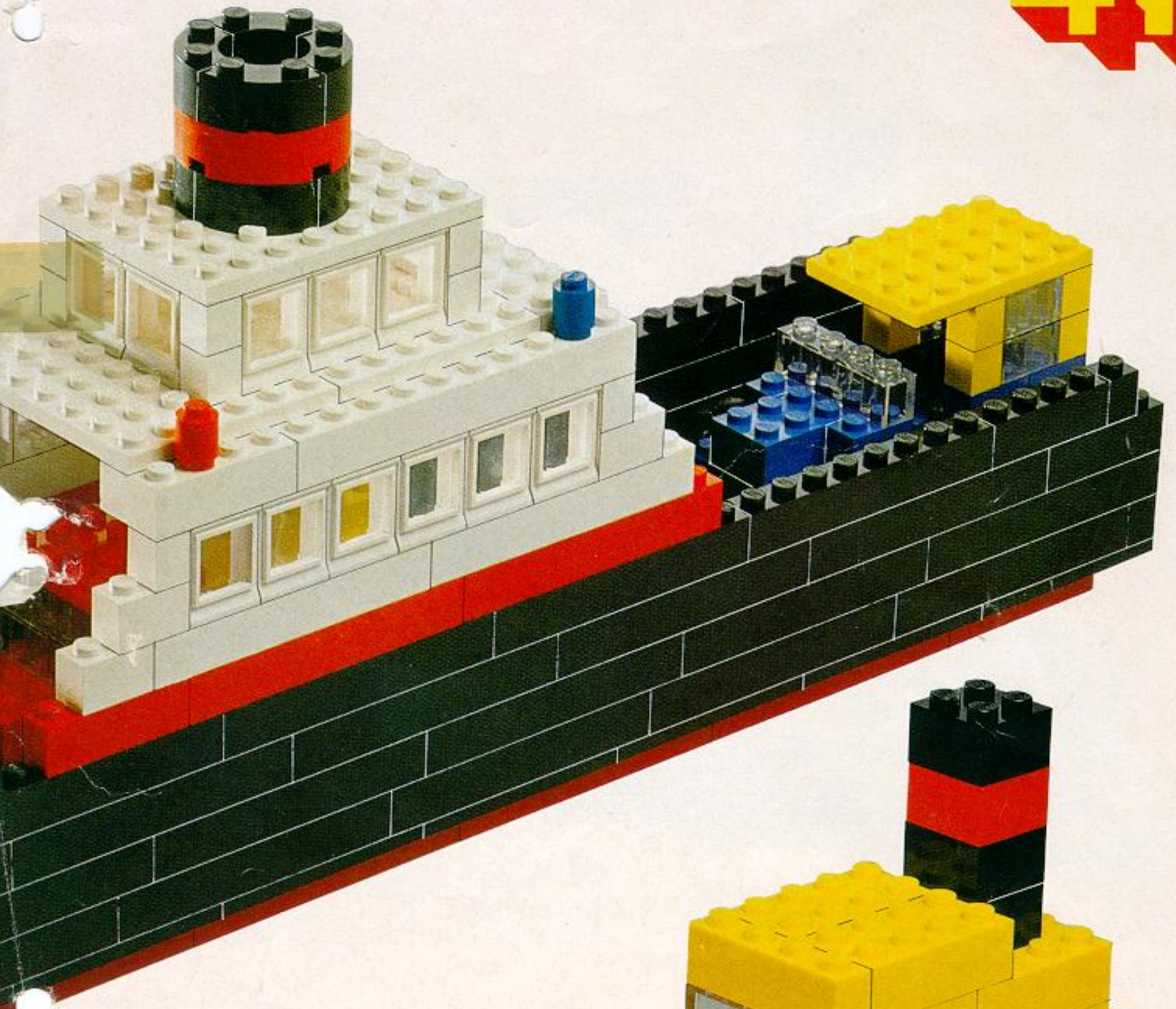

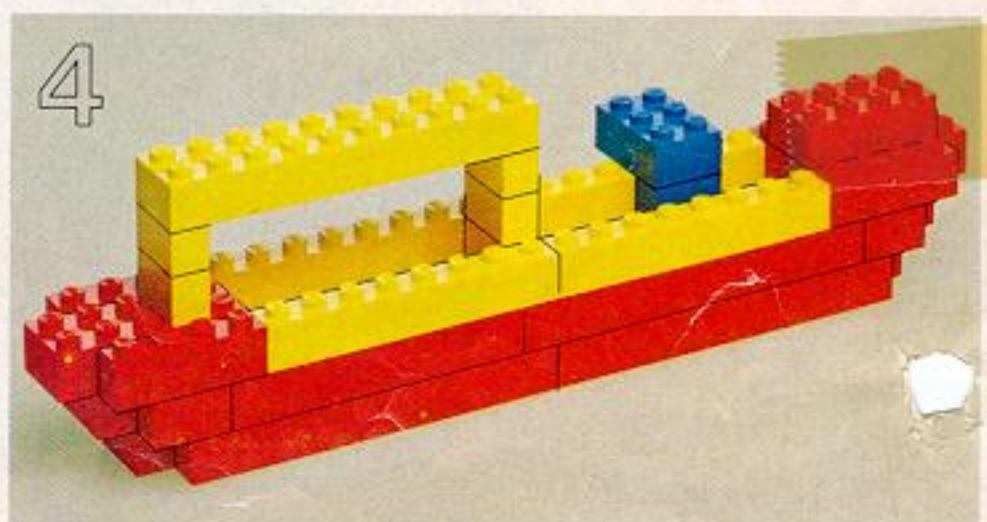
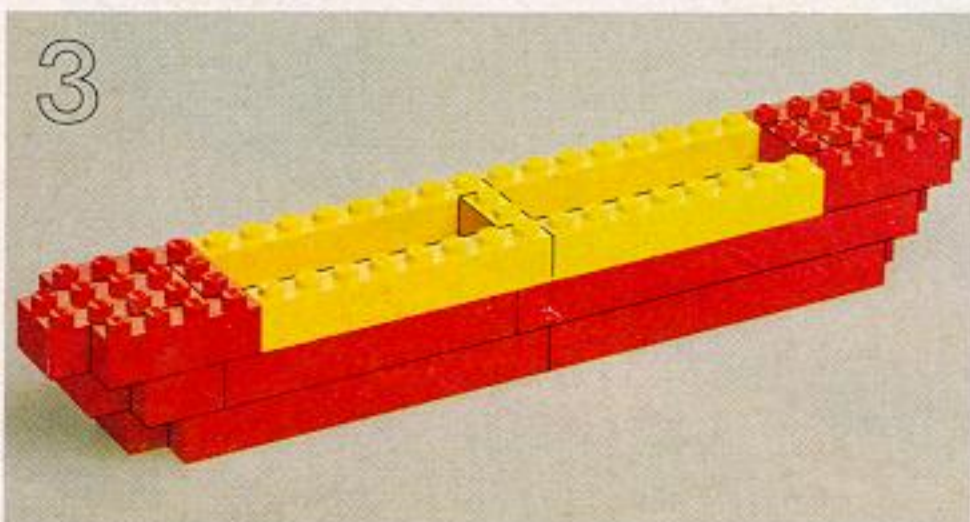
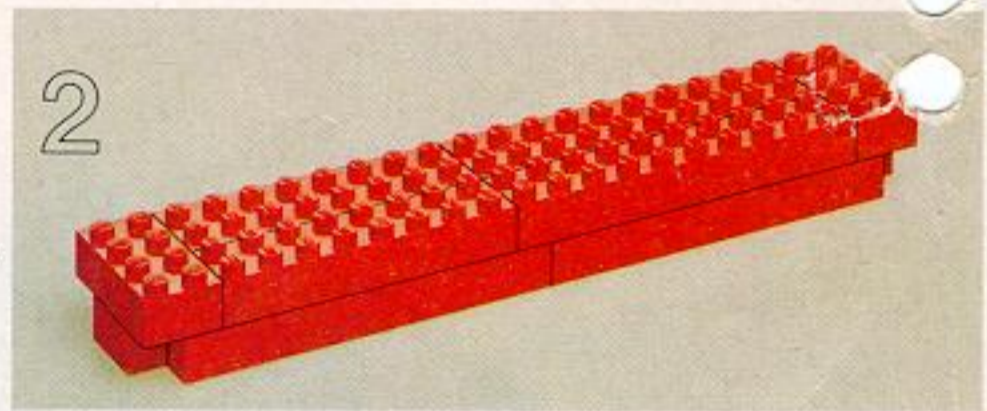
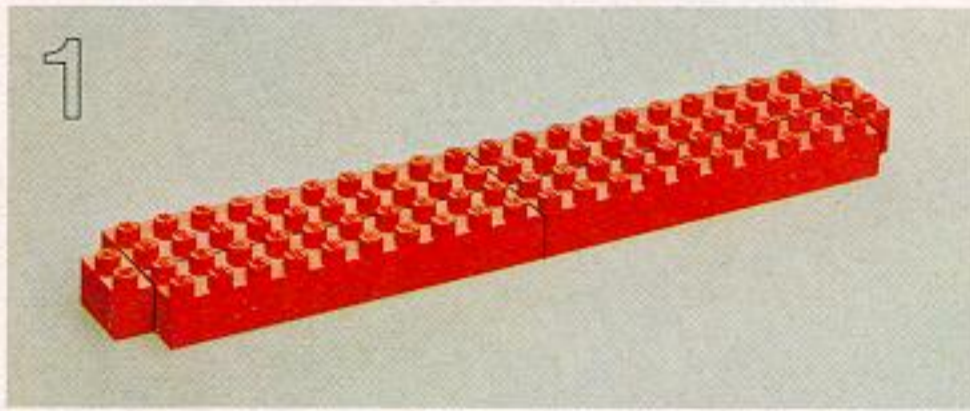

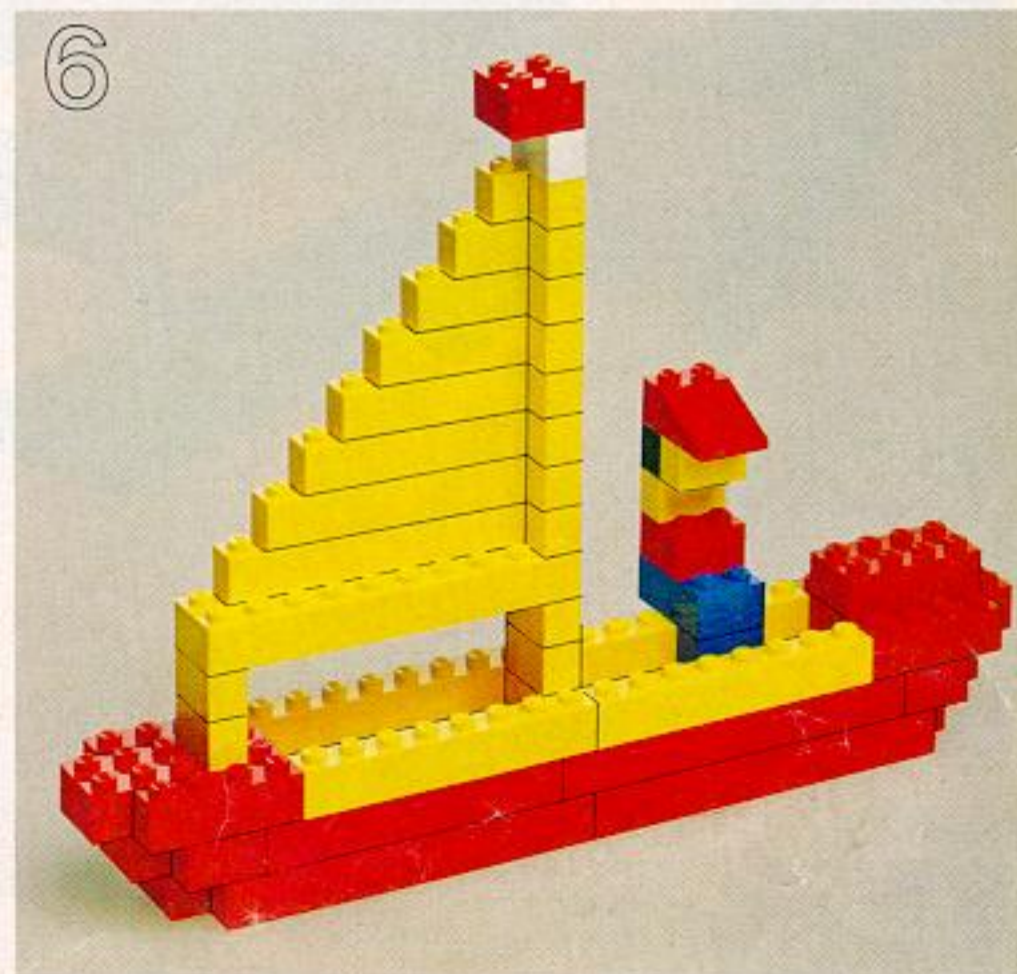
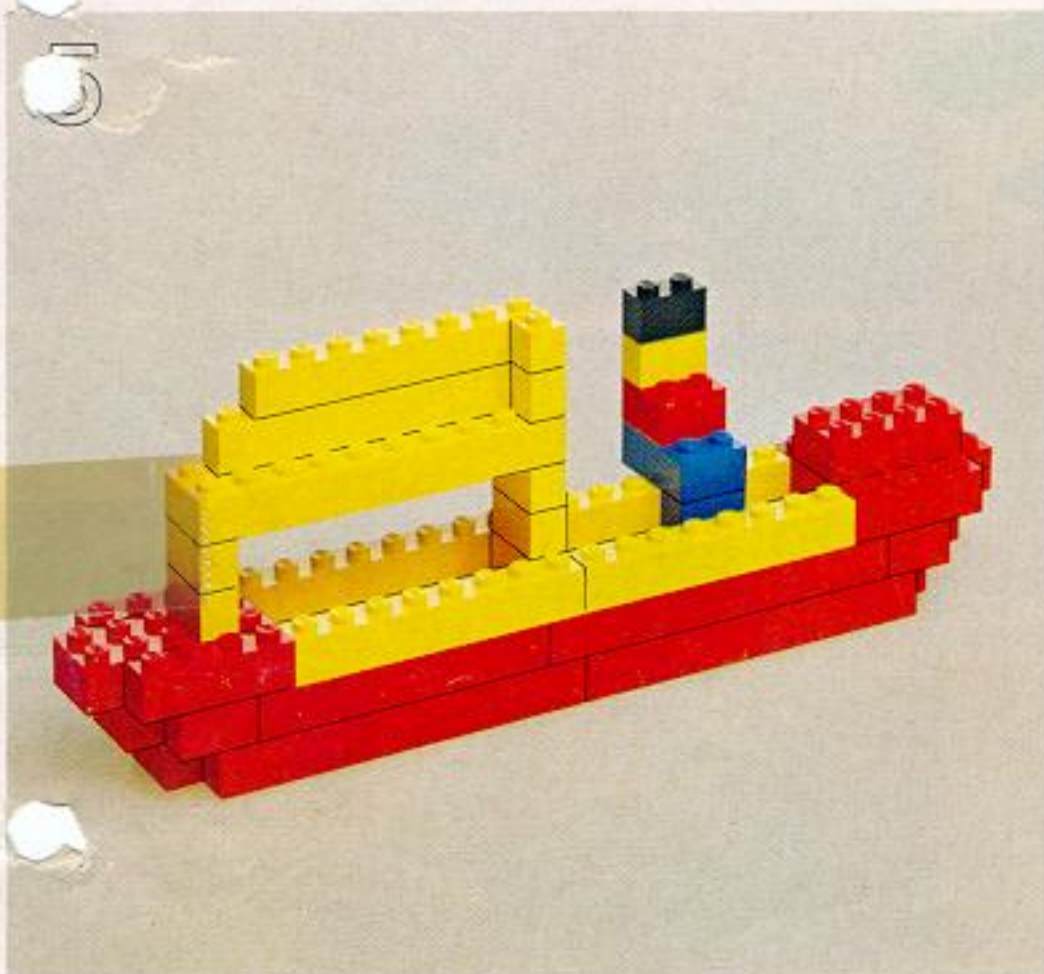
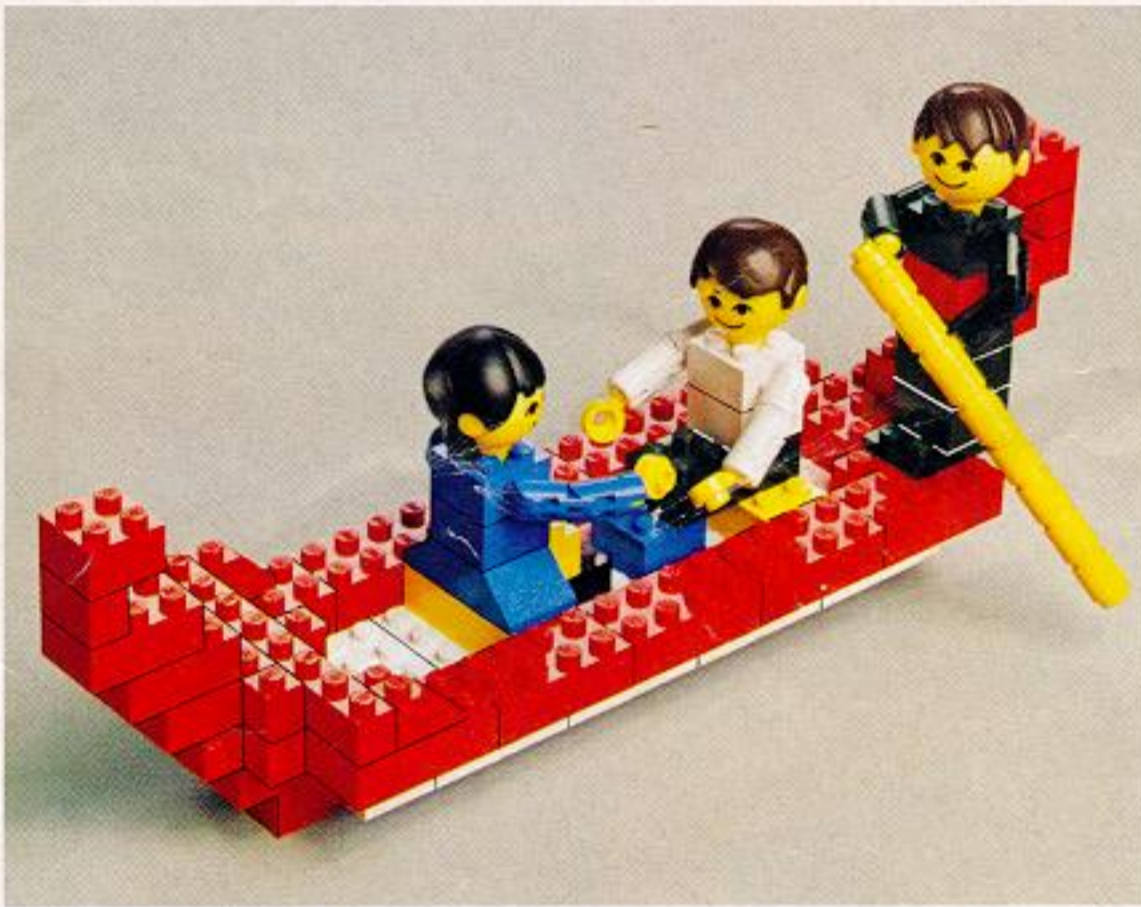
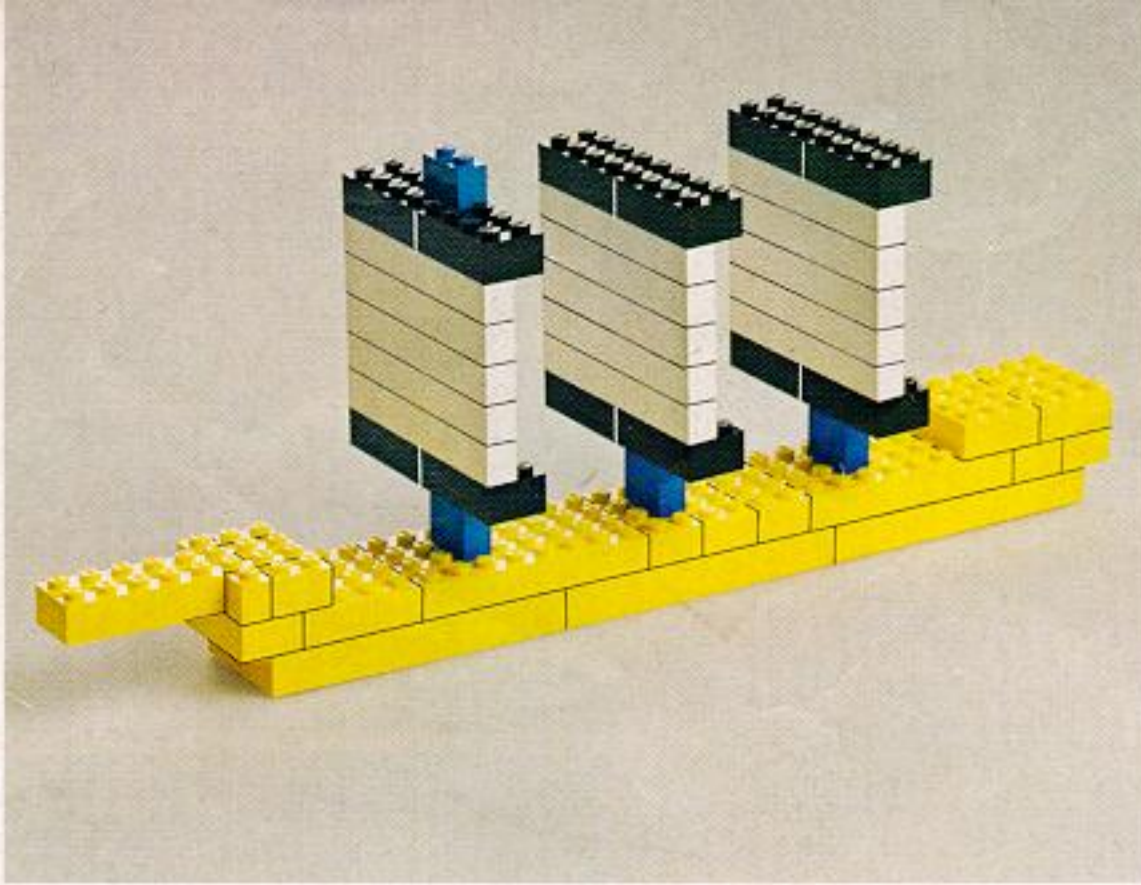

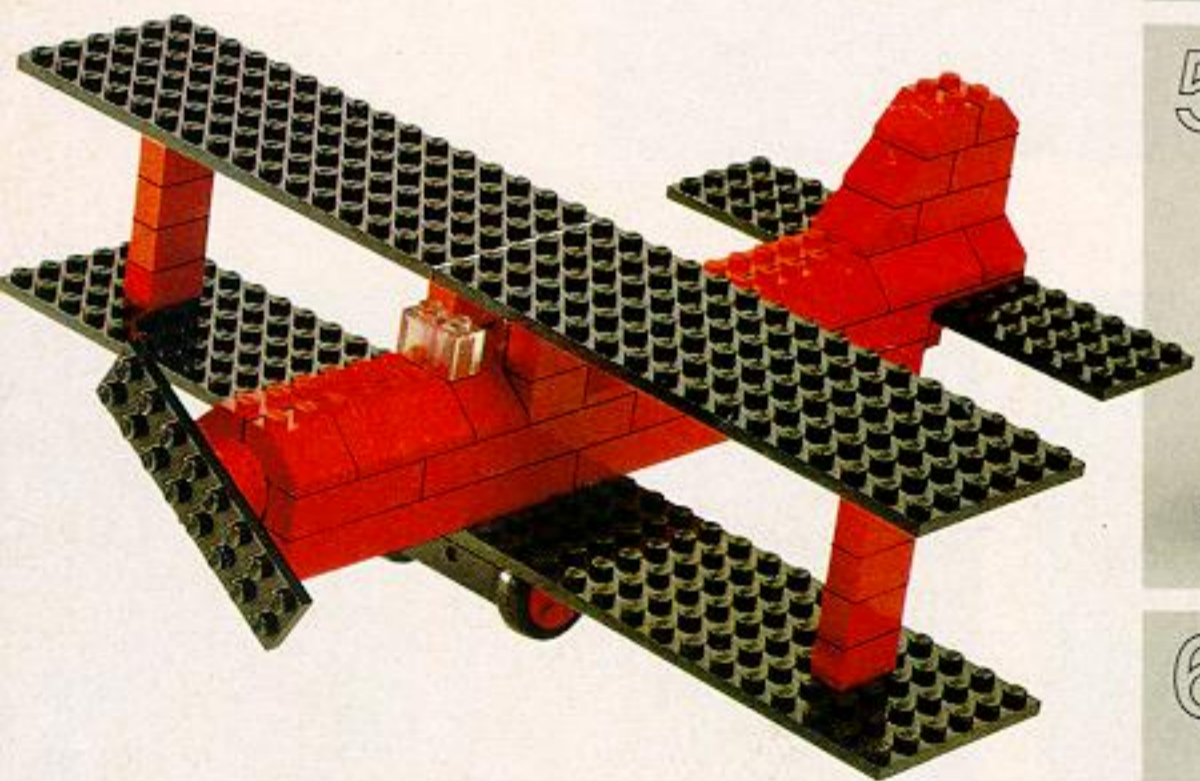
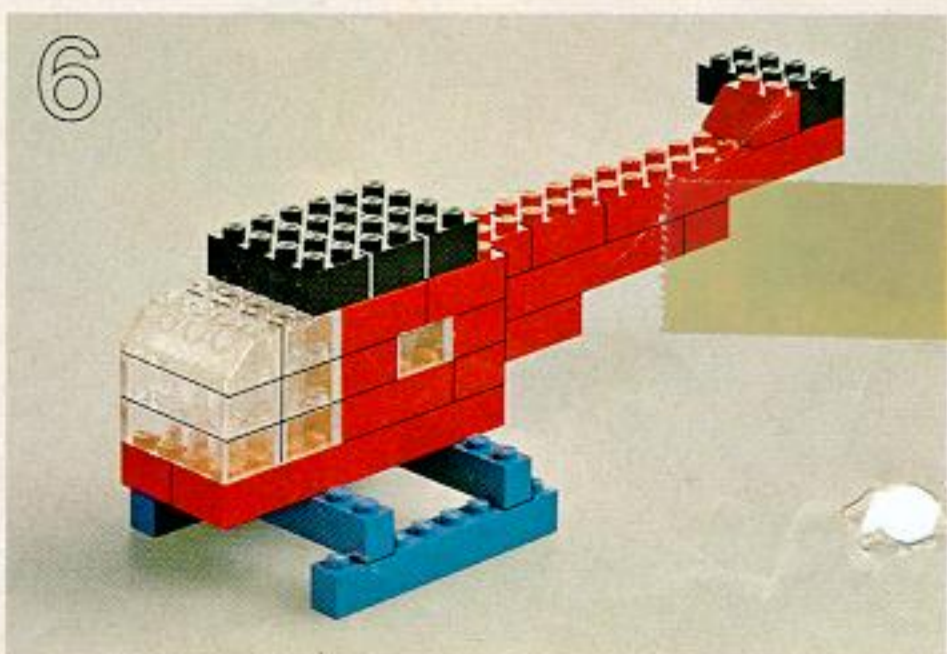
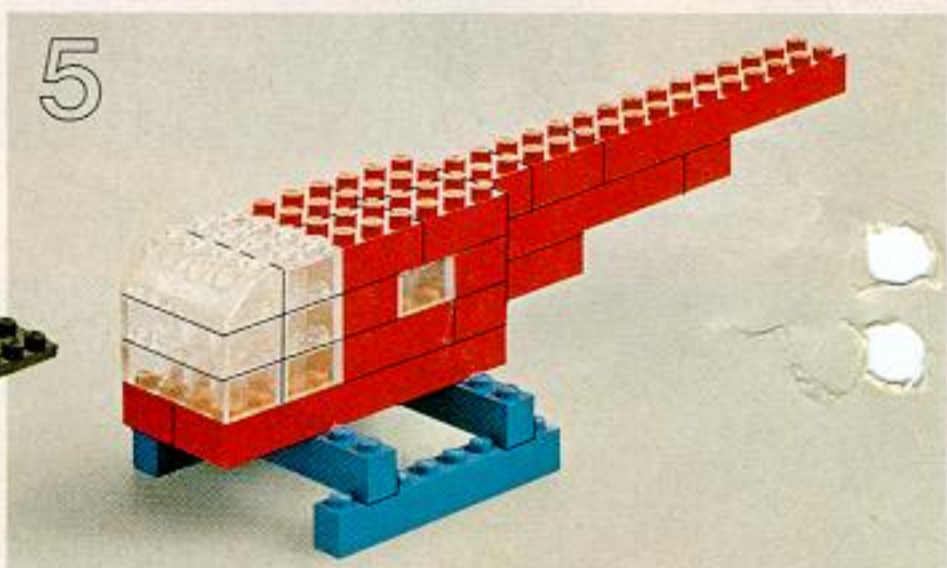
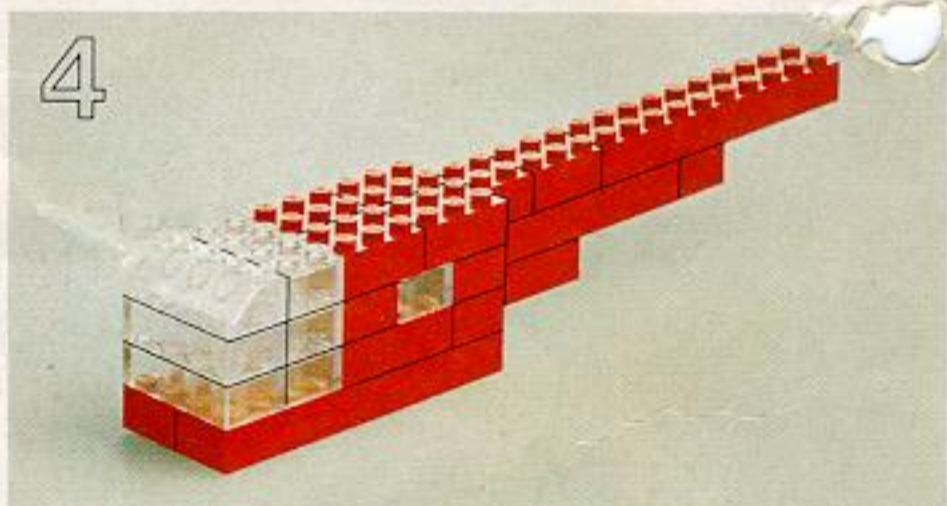
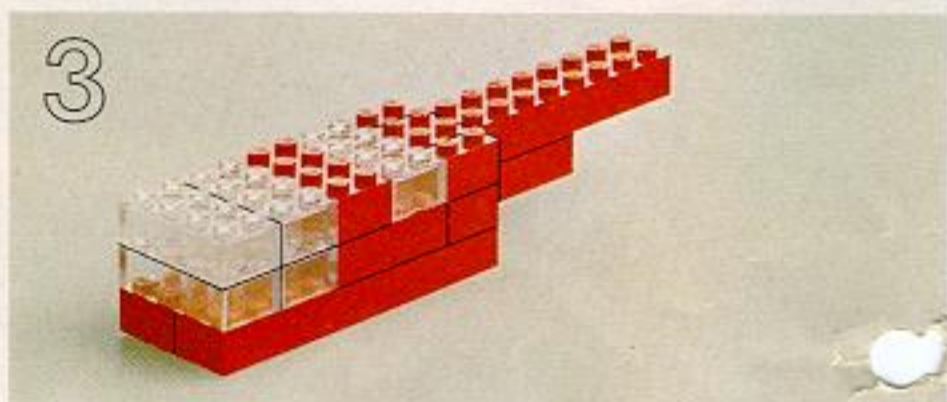
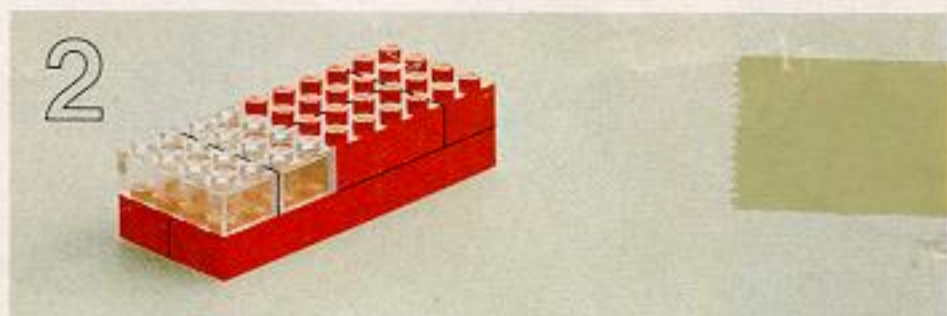
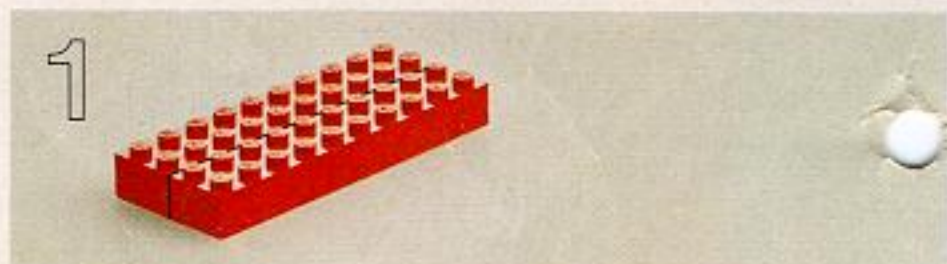

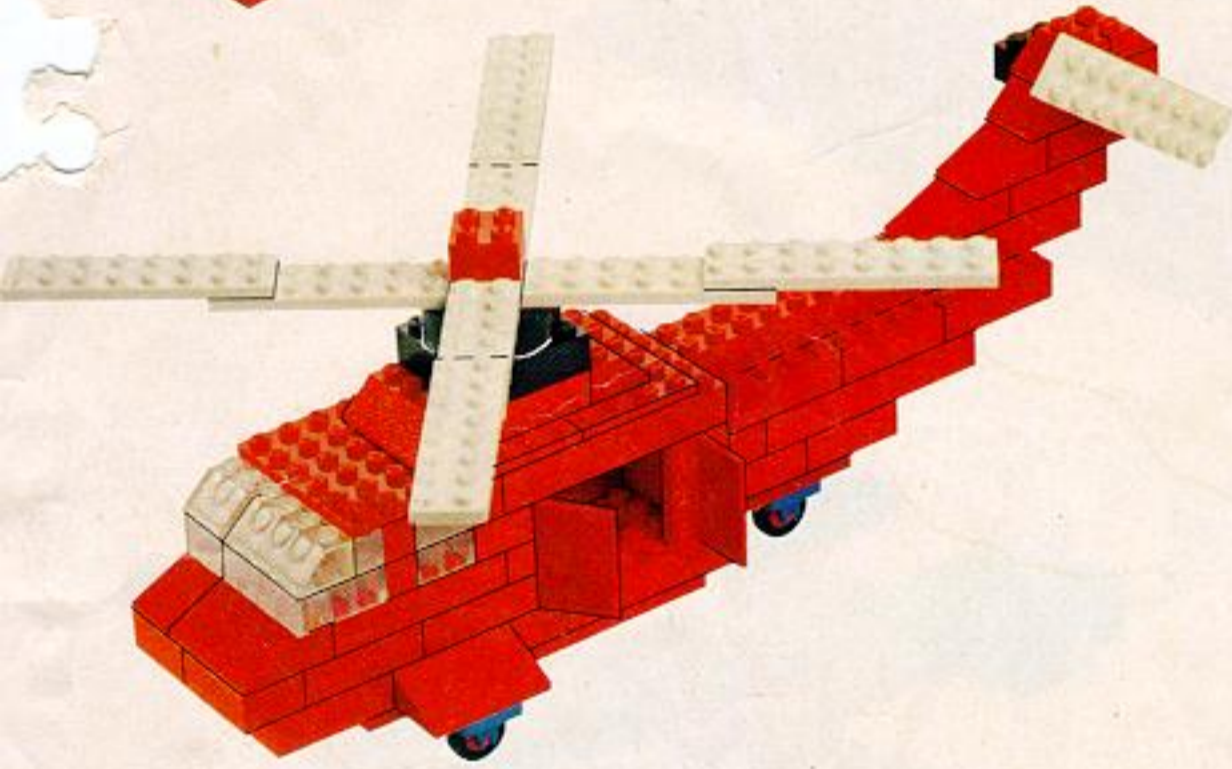
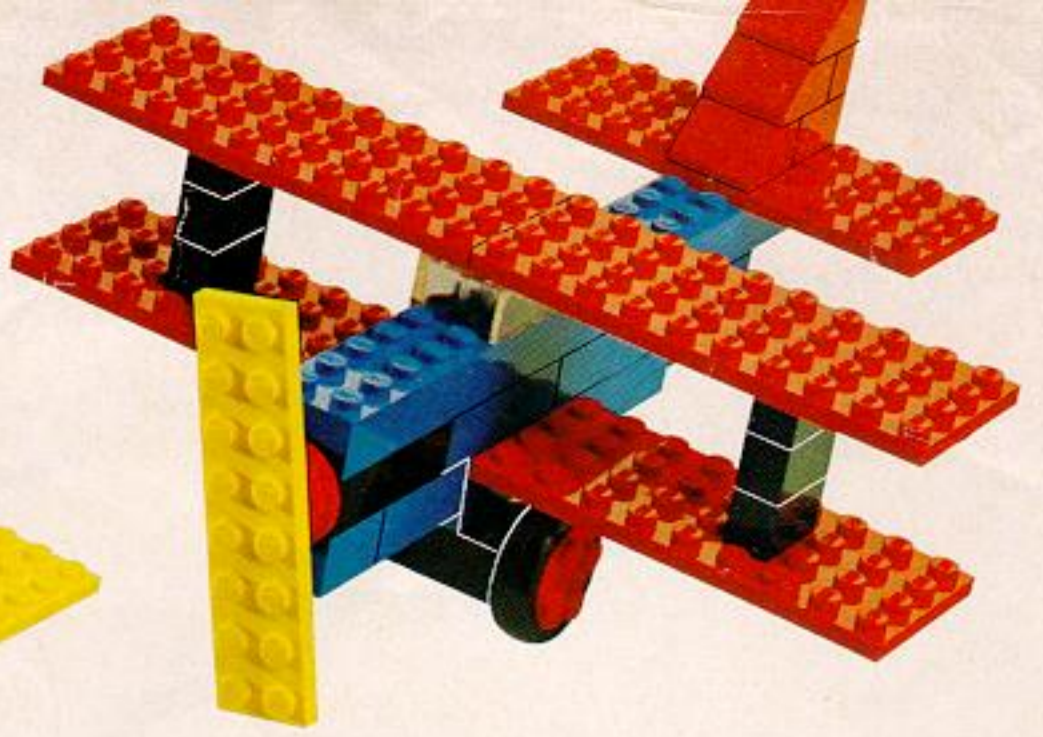
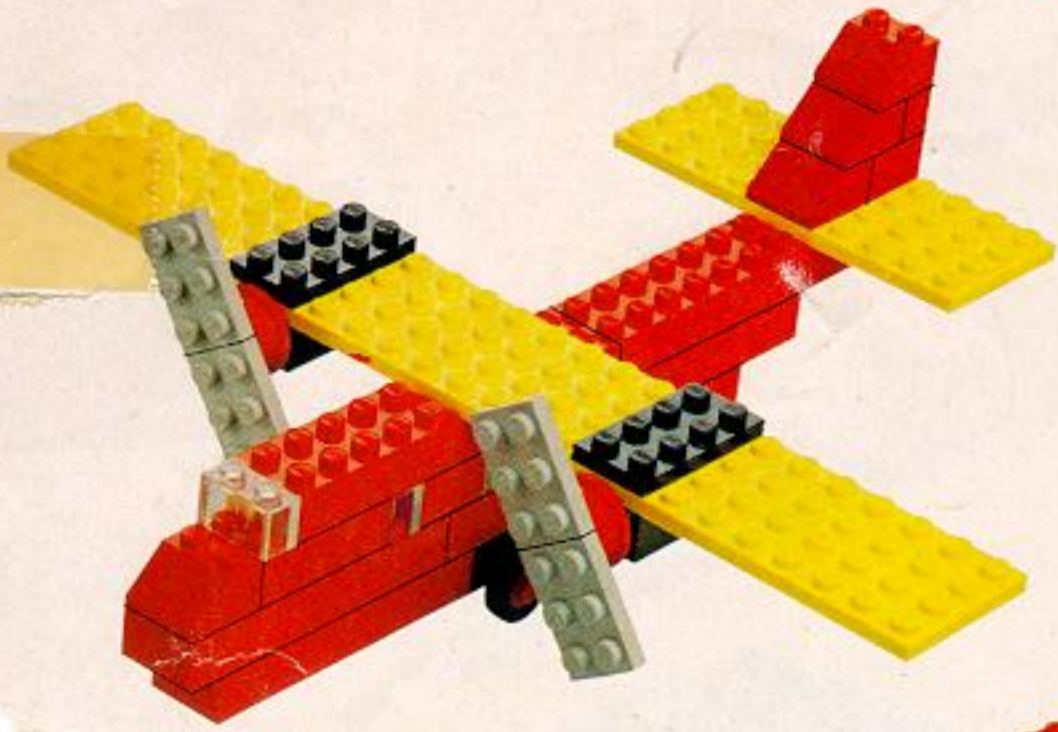

46

1

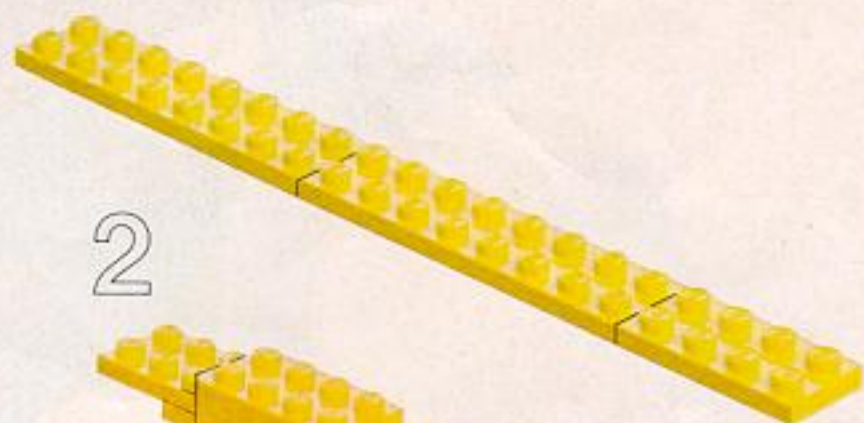

2

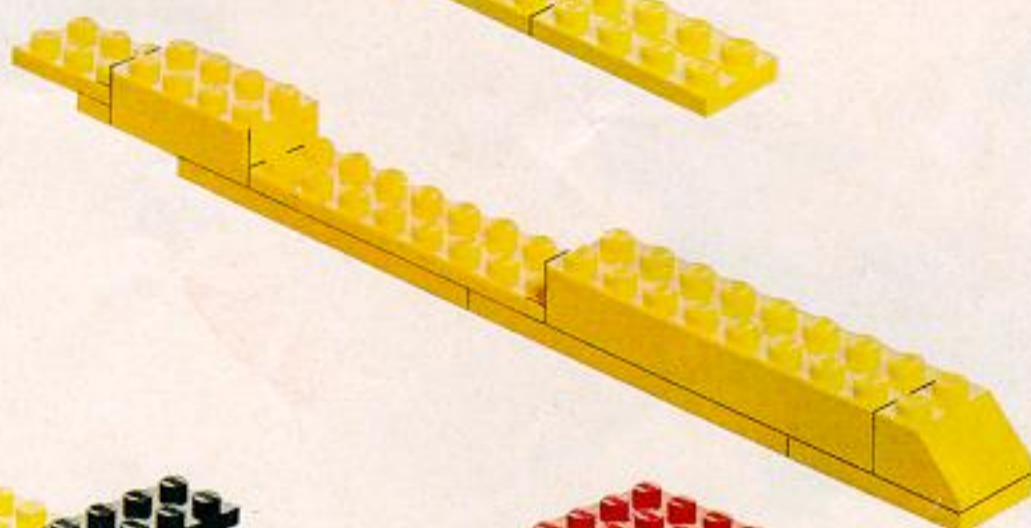

3

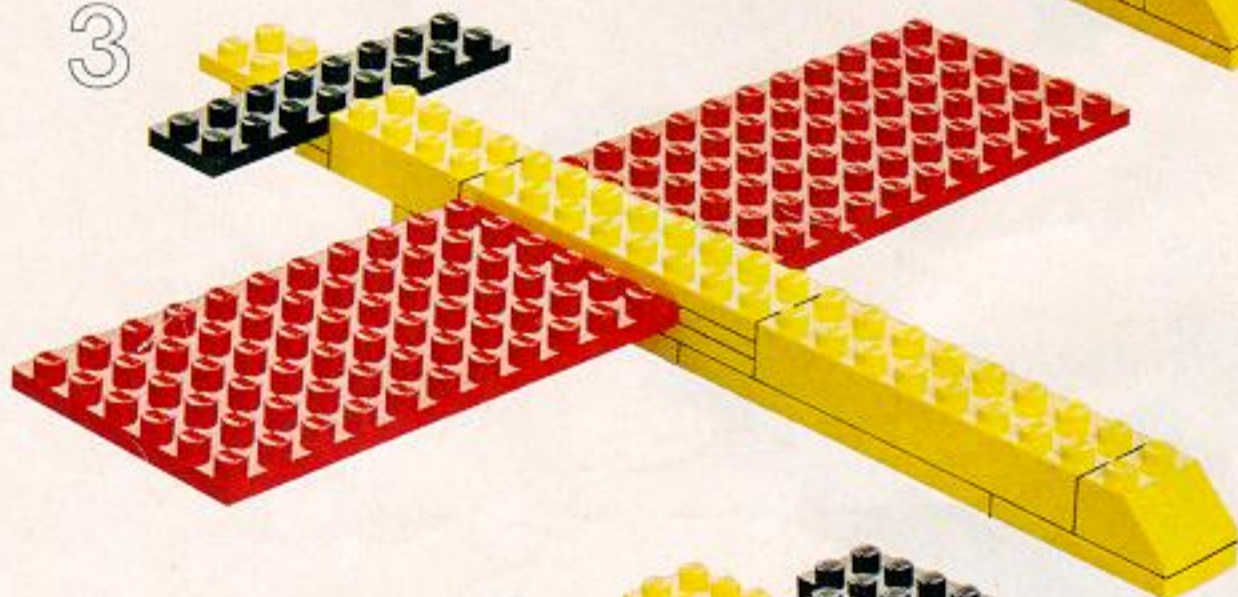

4

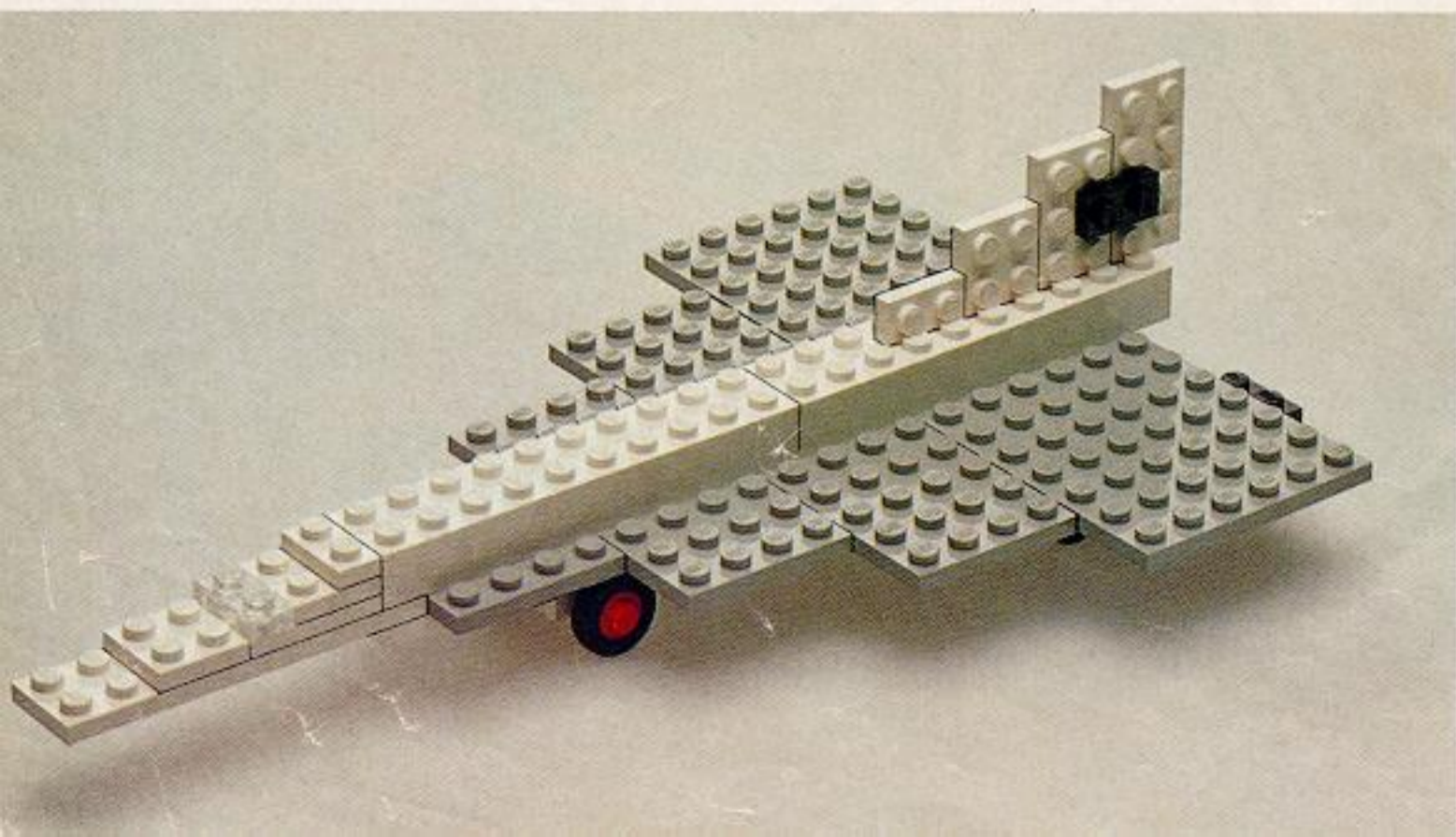
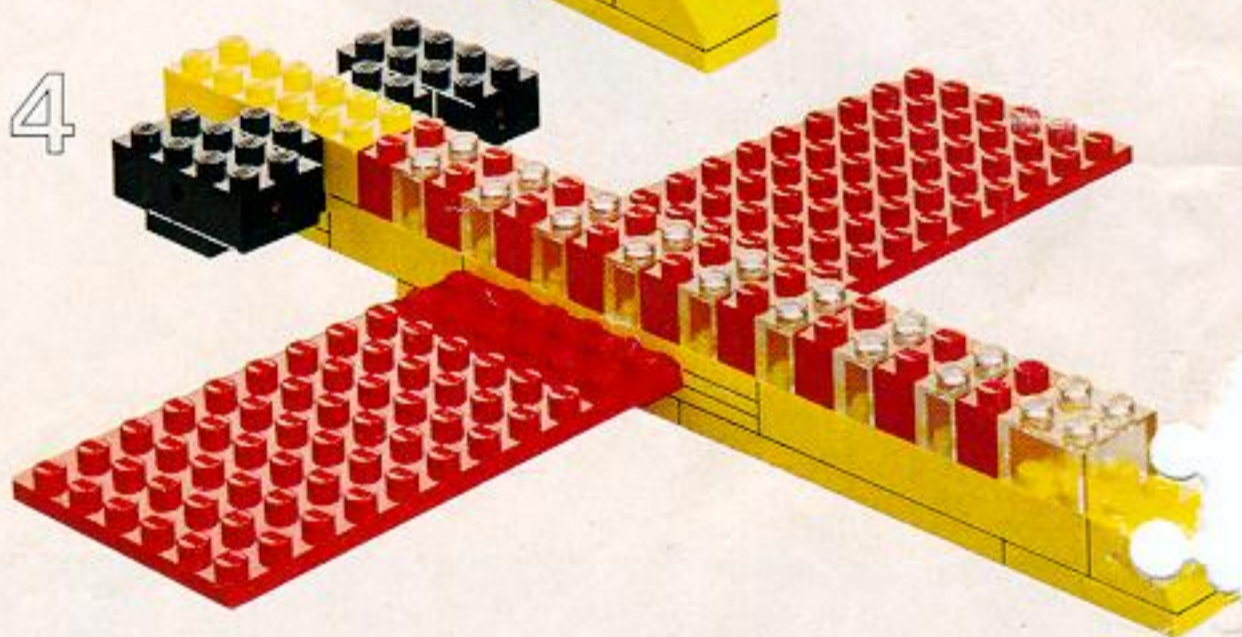

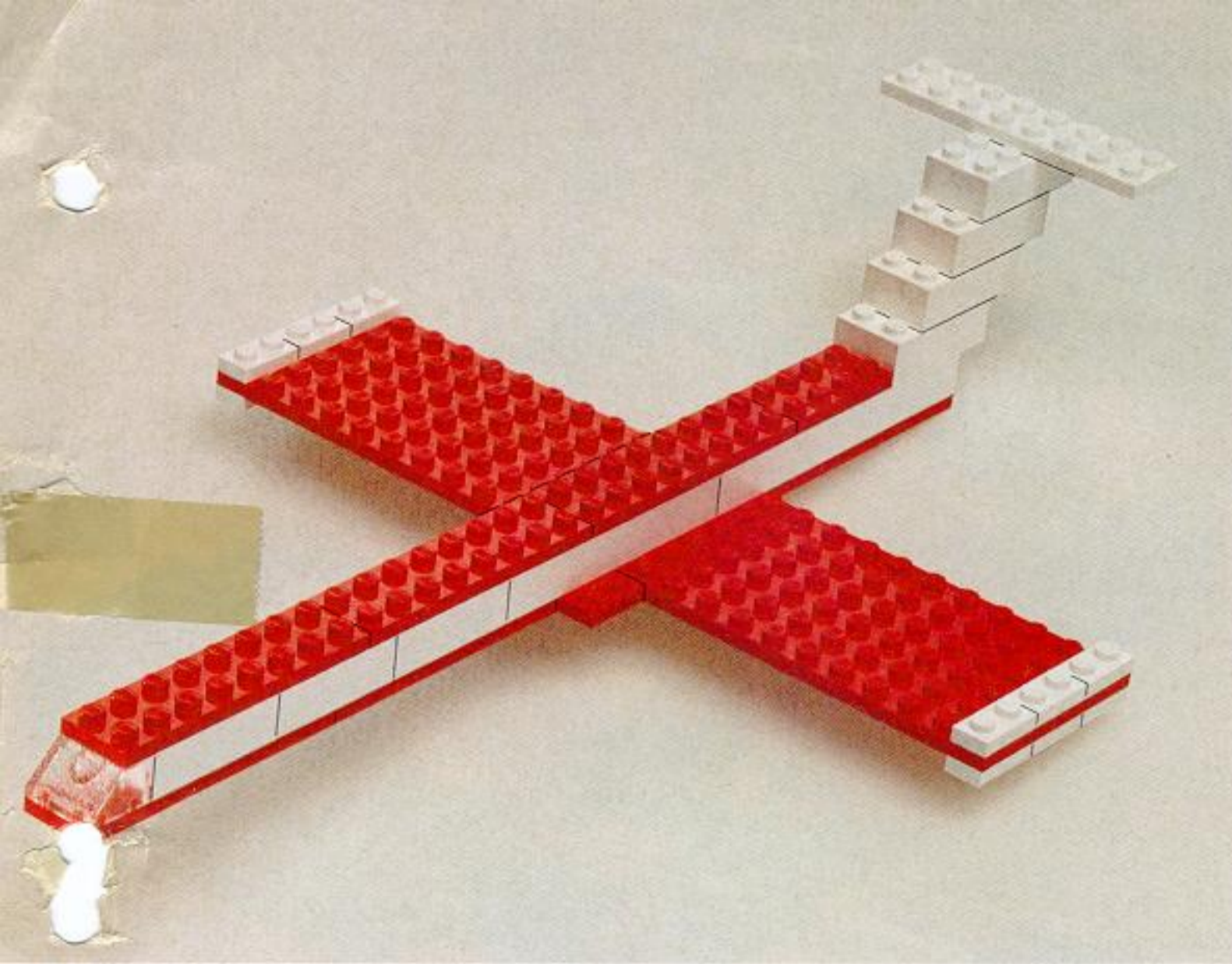

5

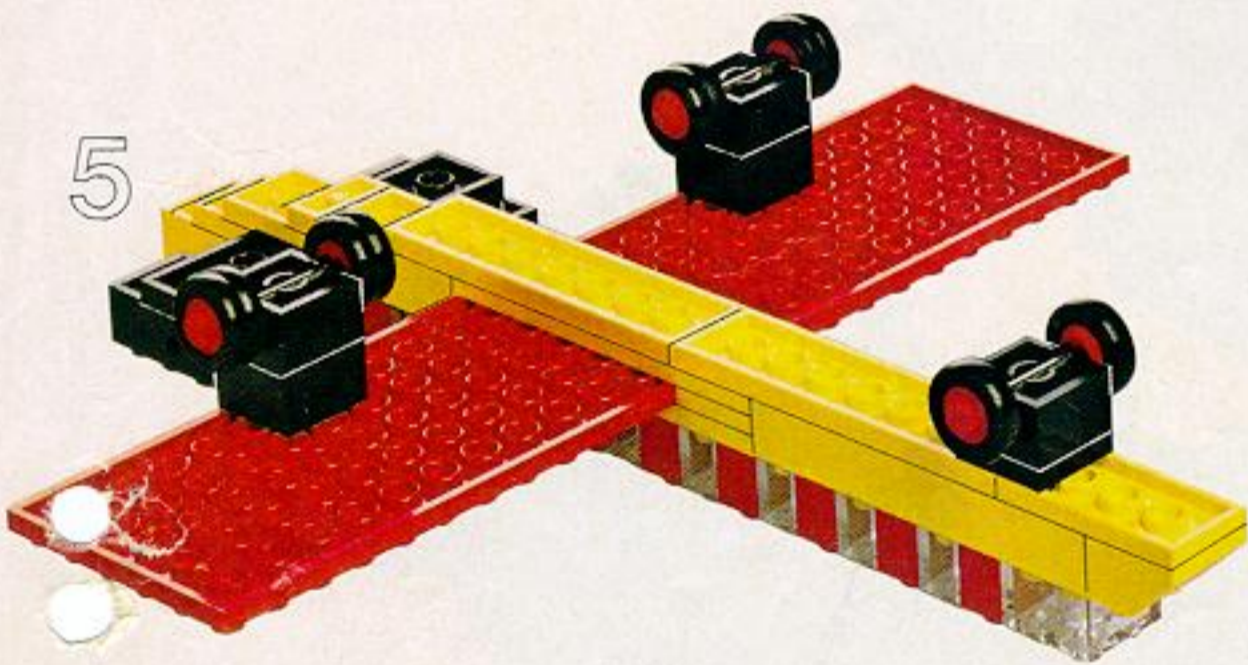

6

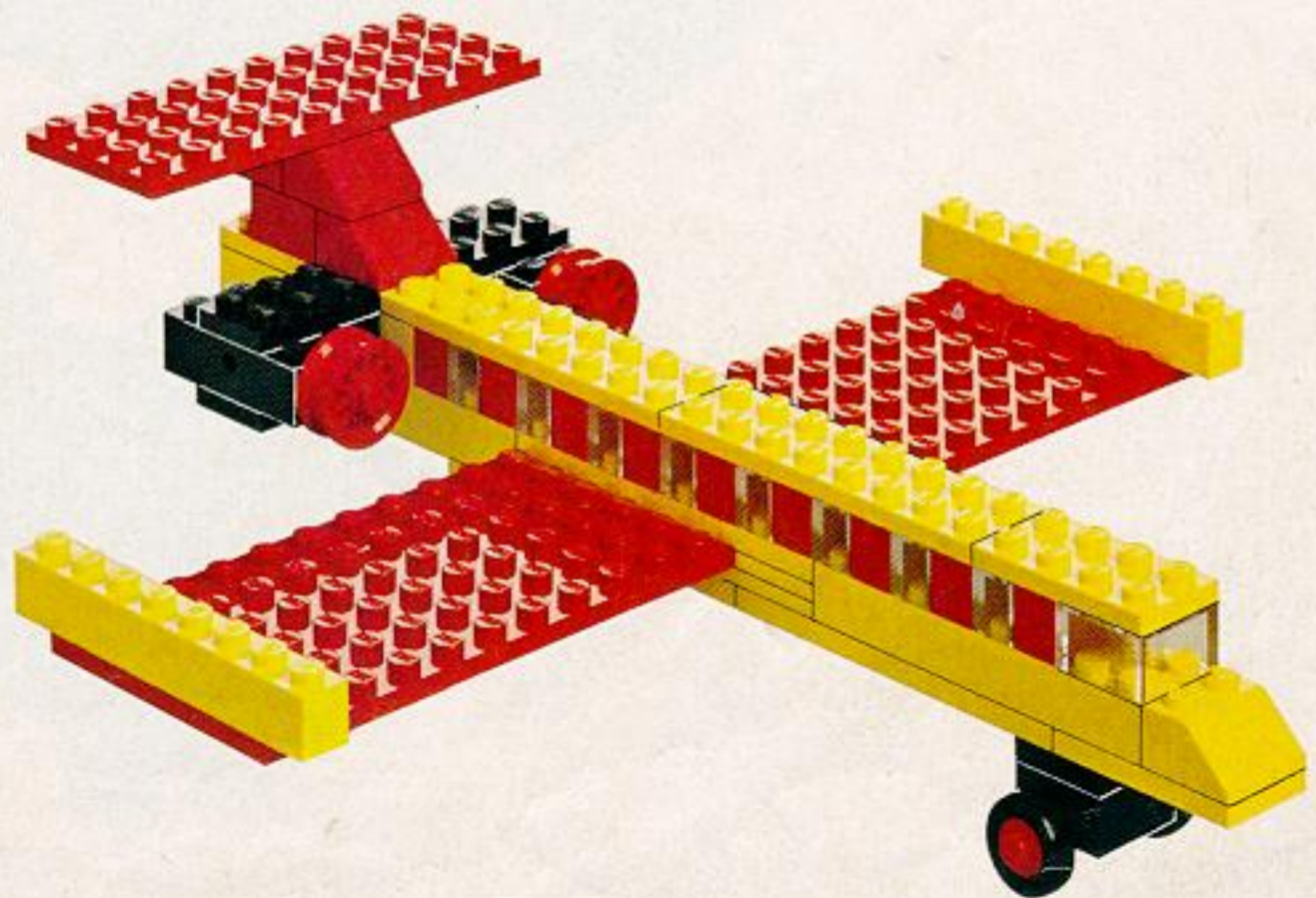

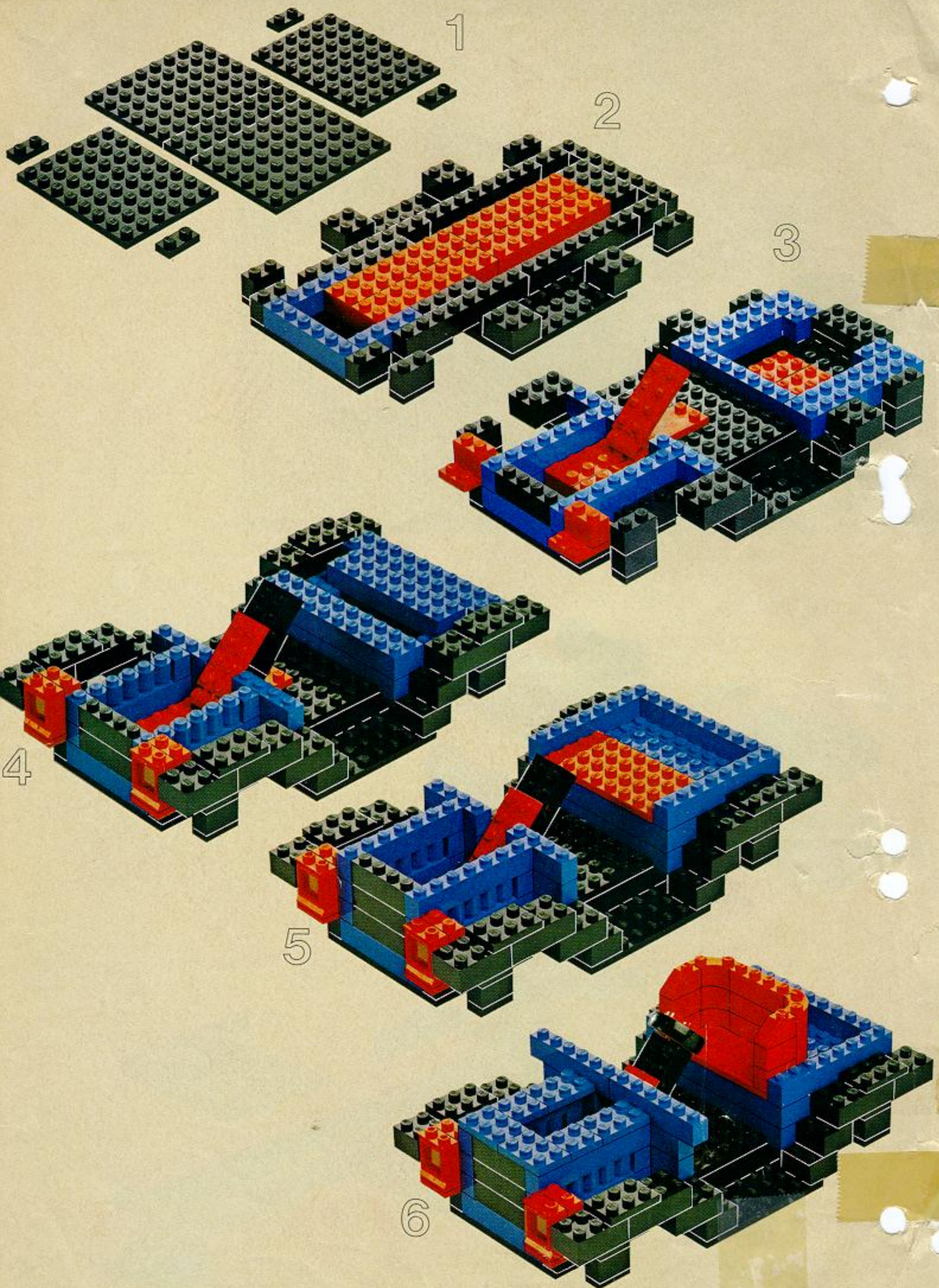

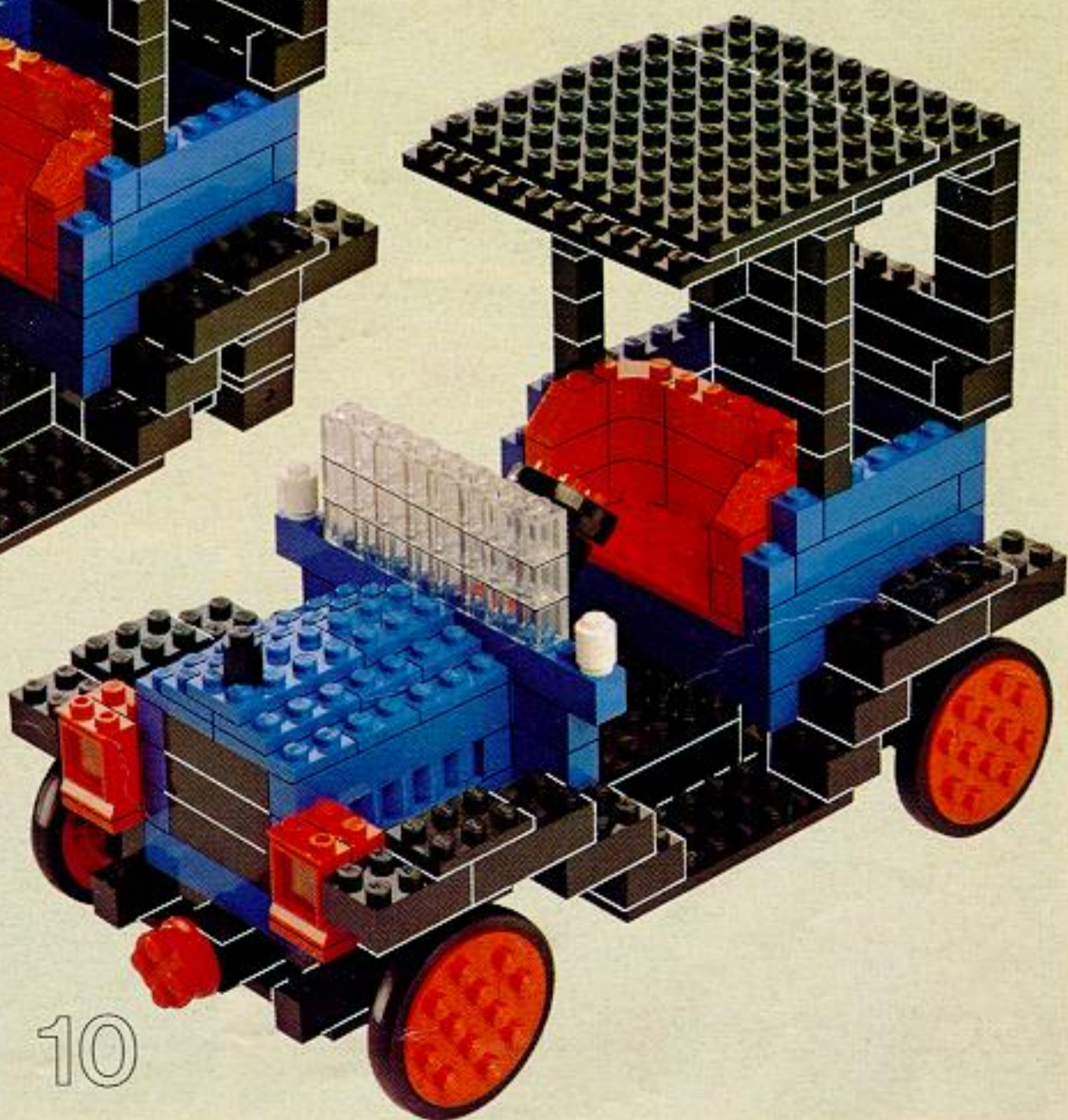
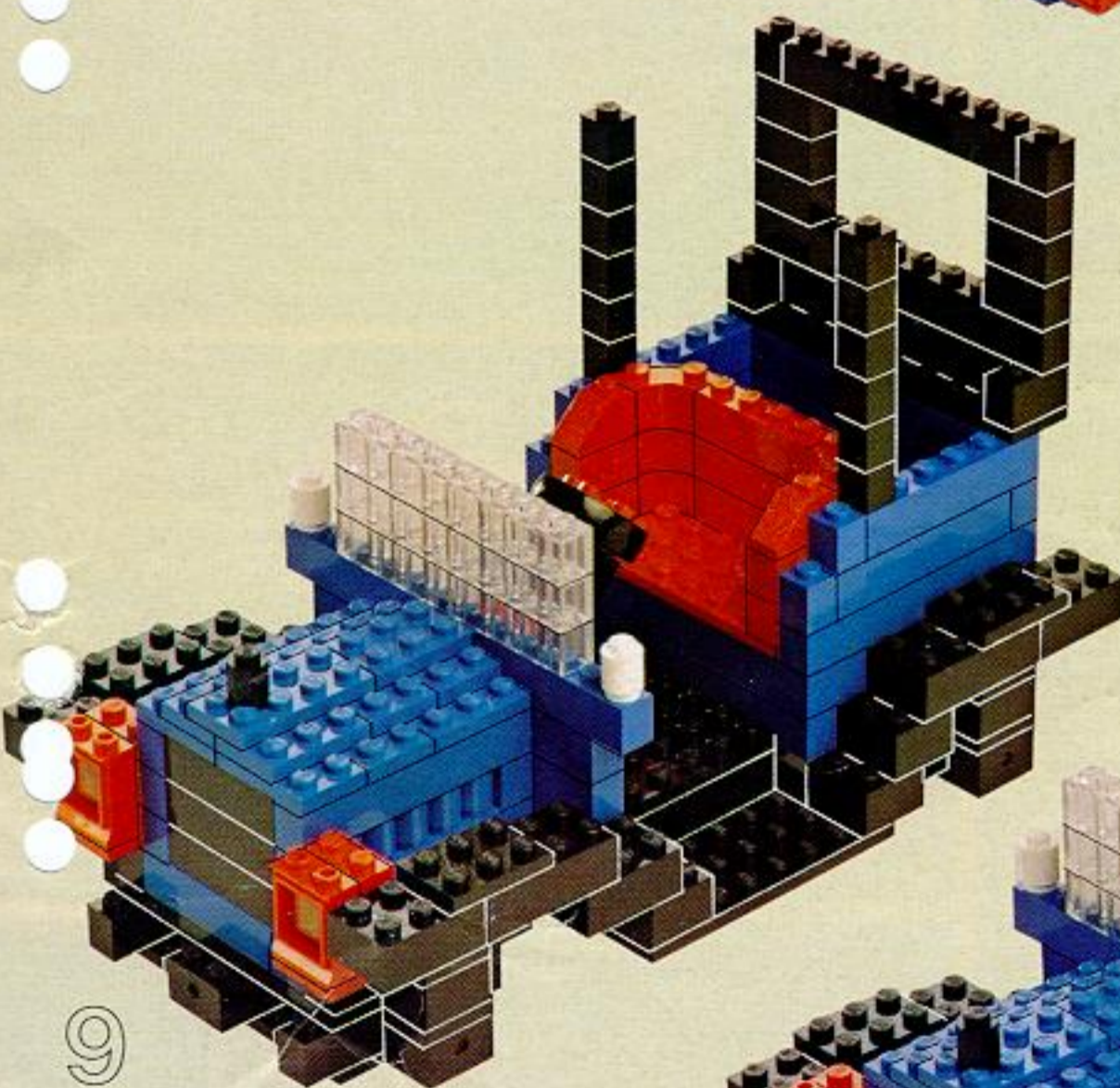
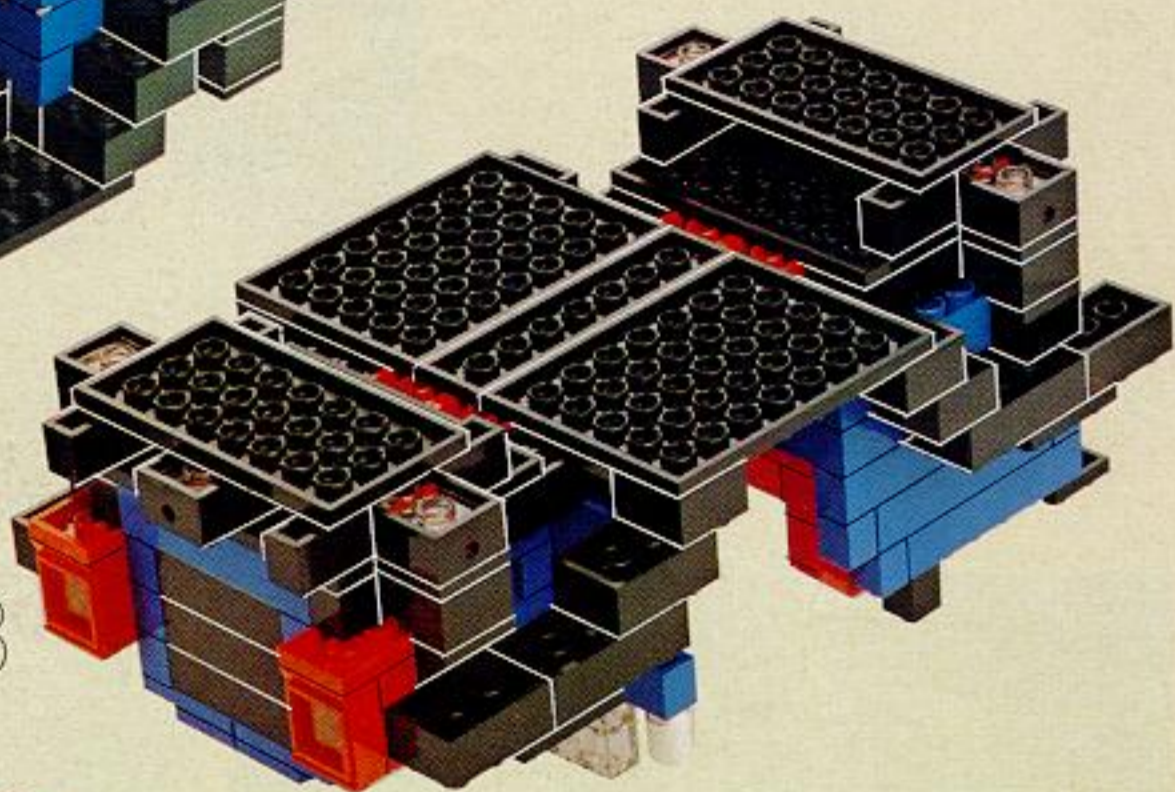
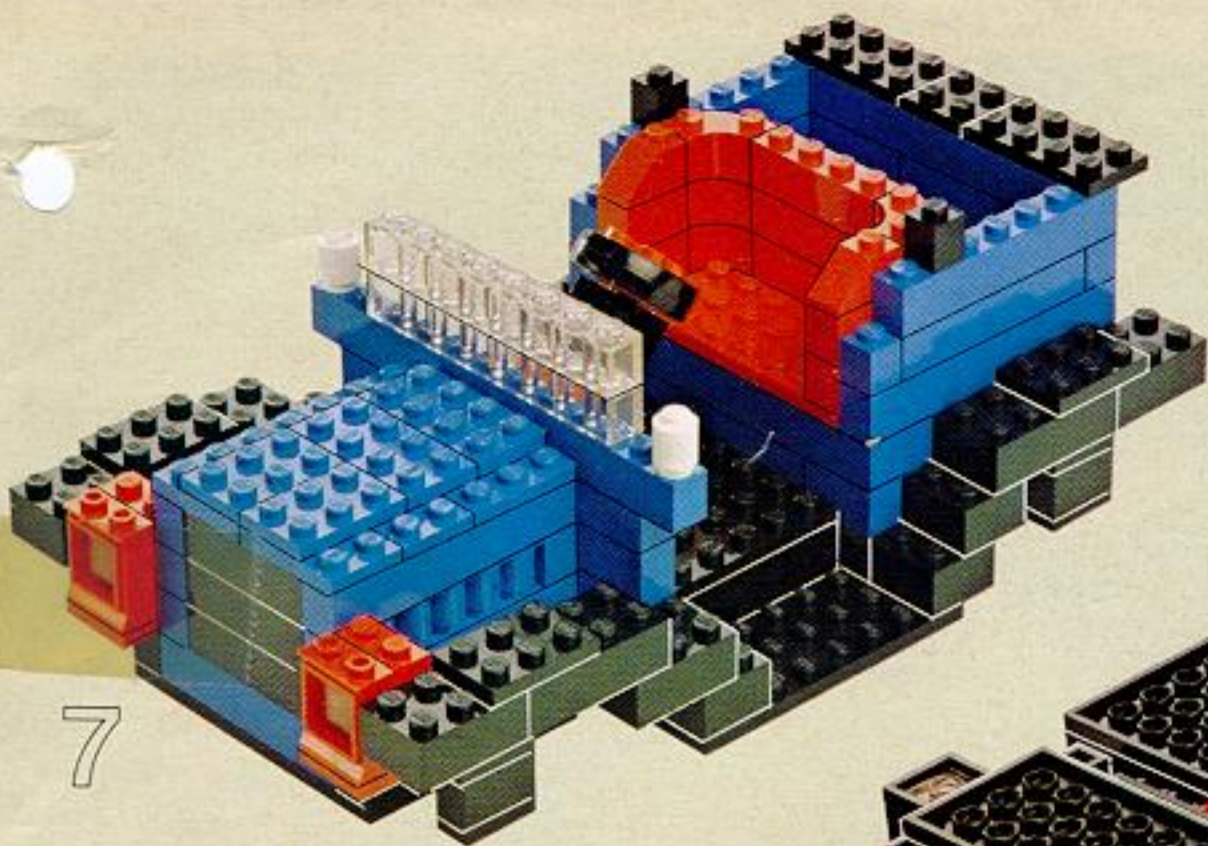

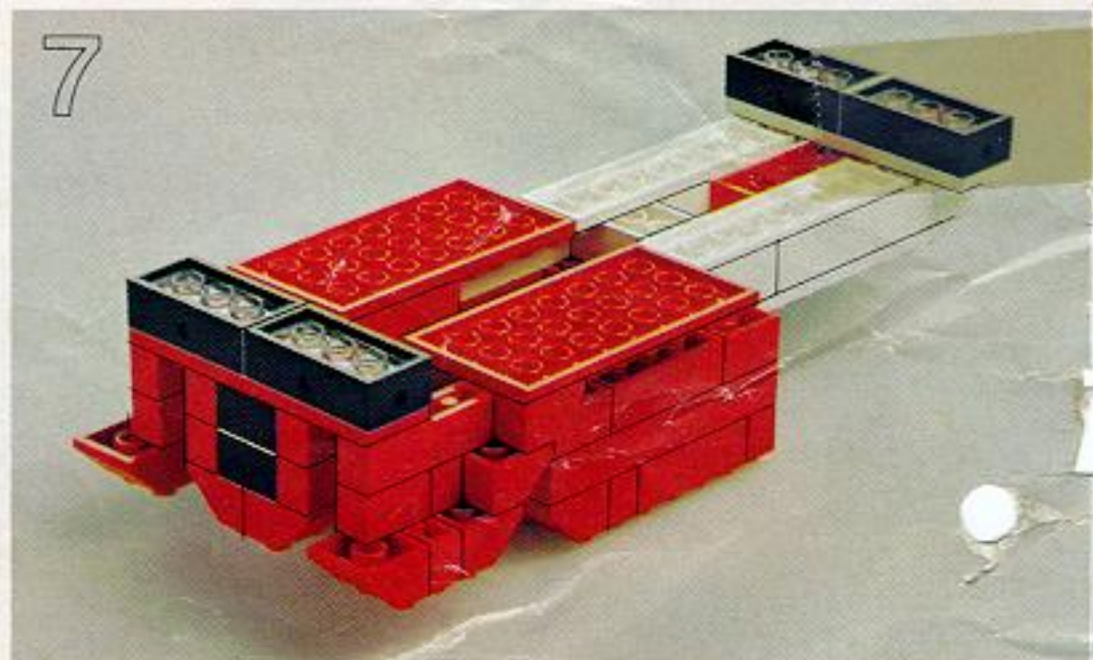
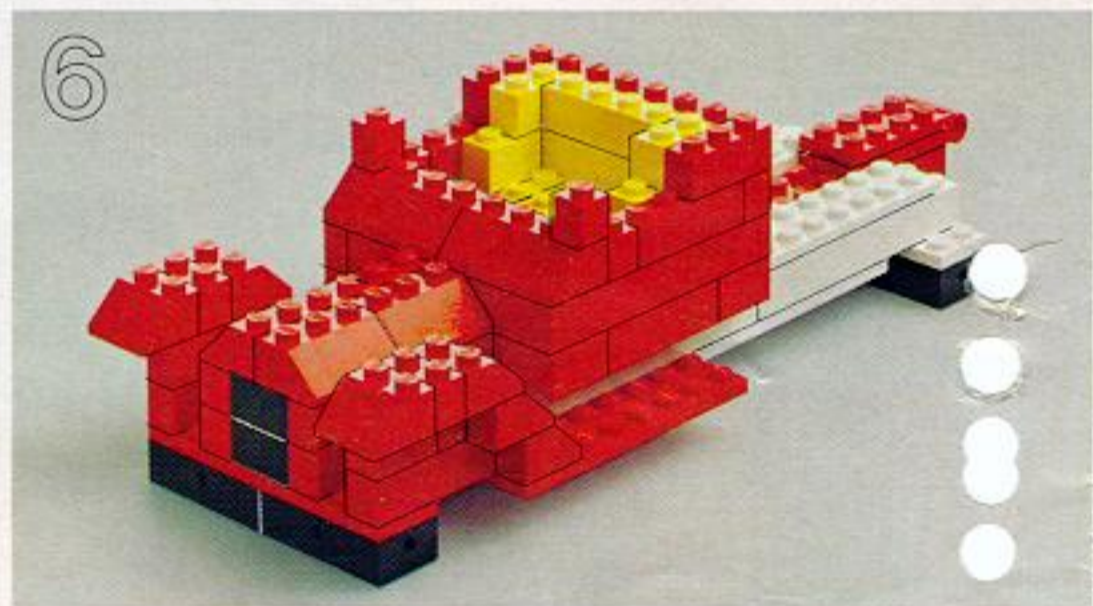
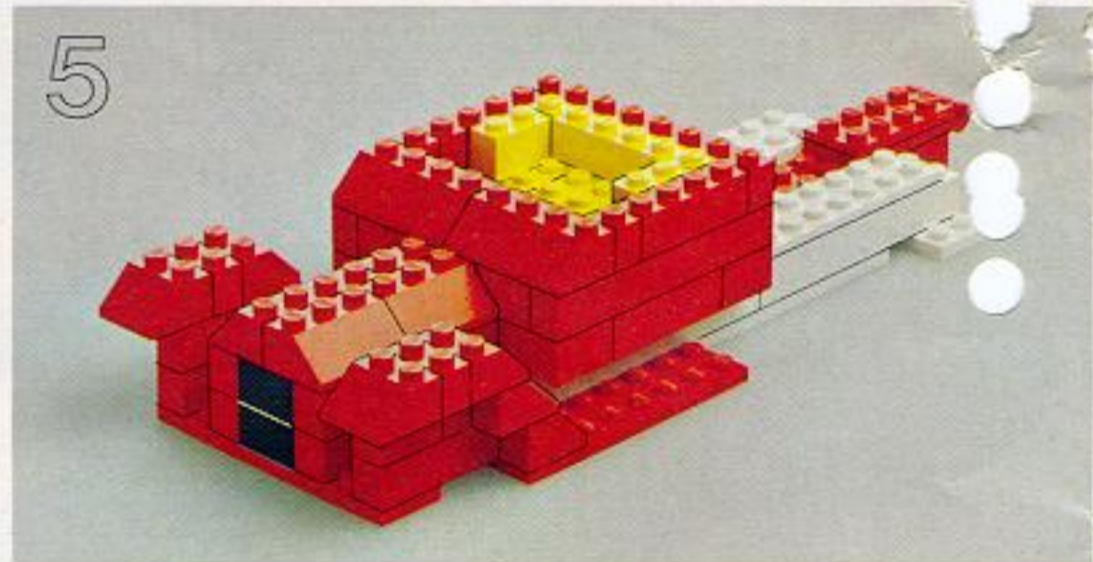
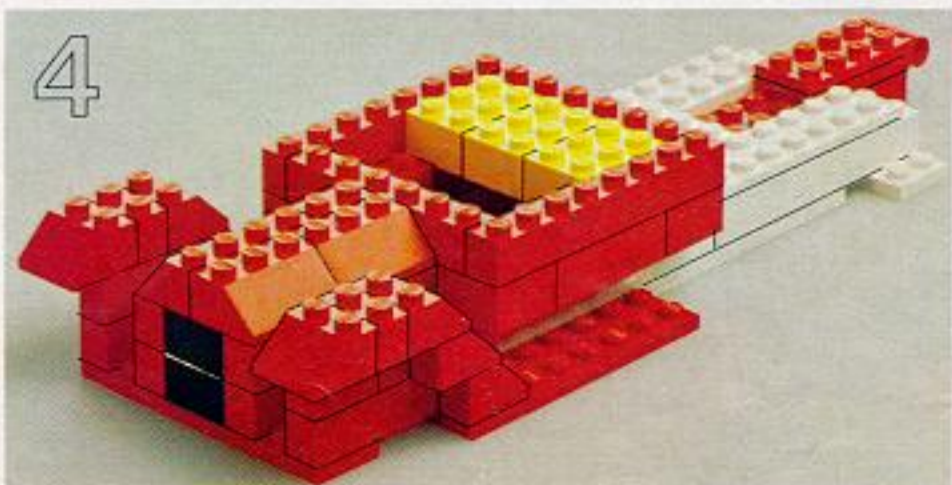
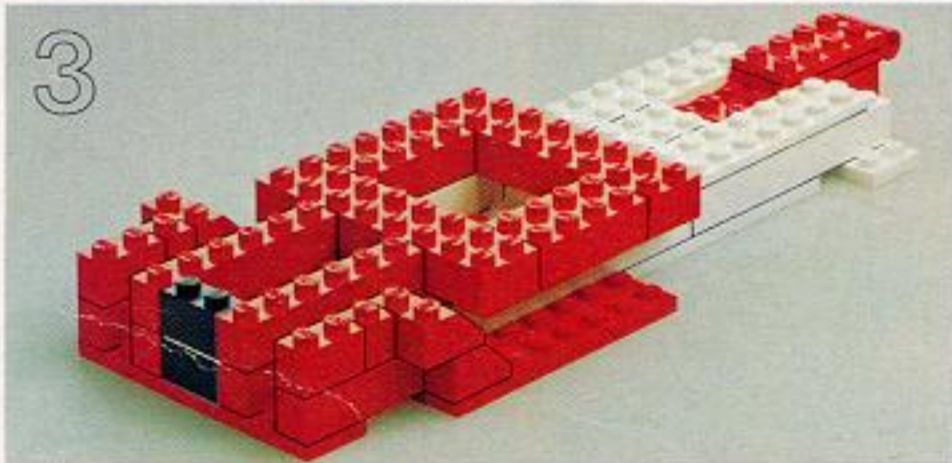
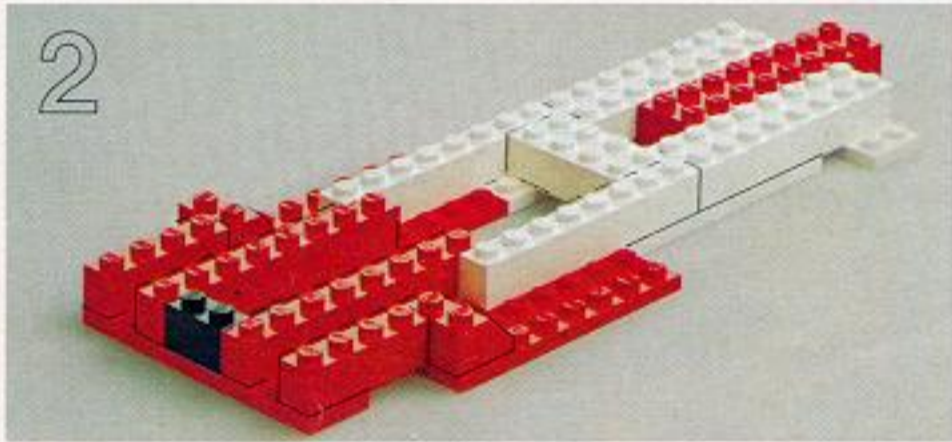
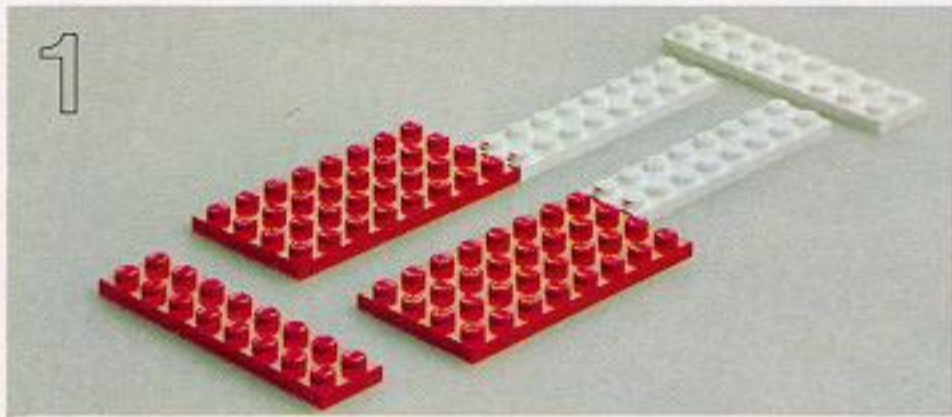
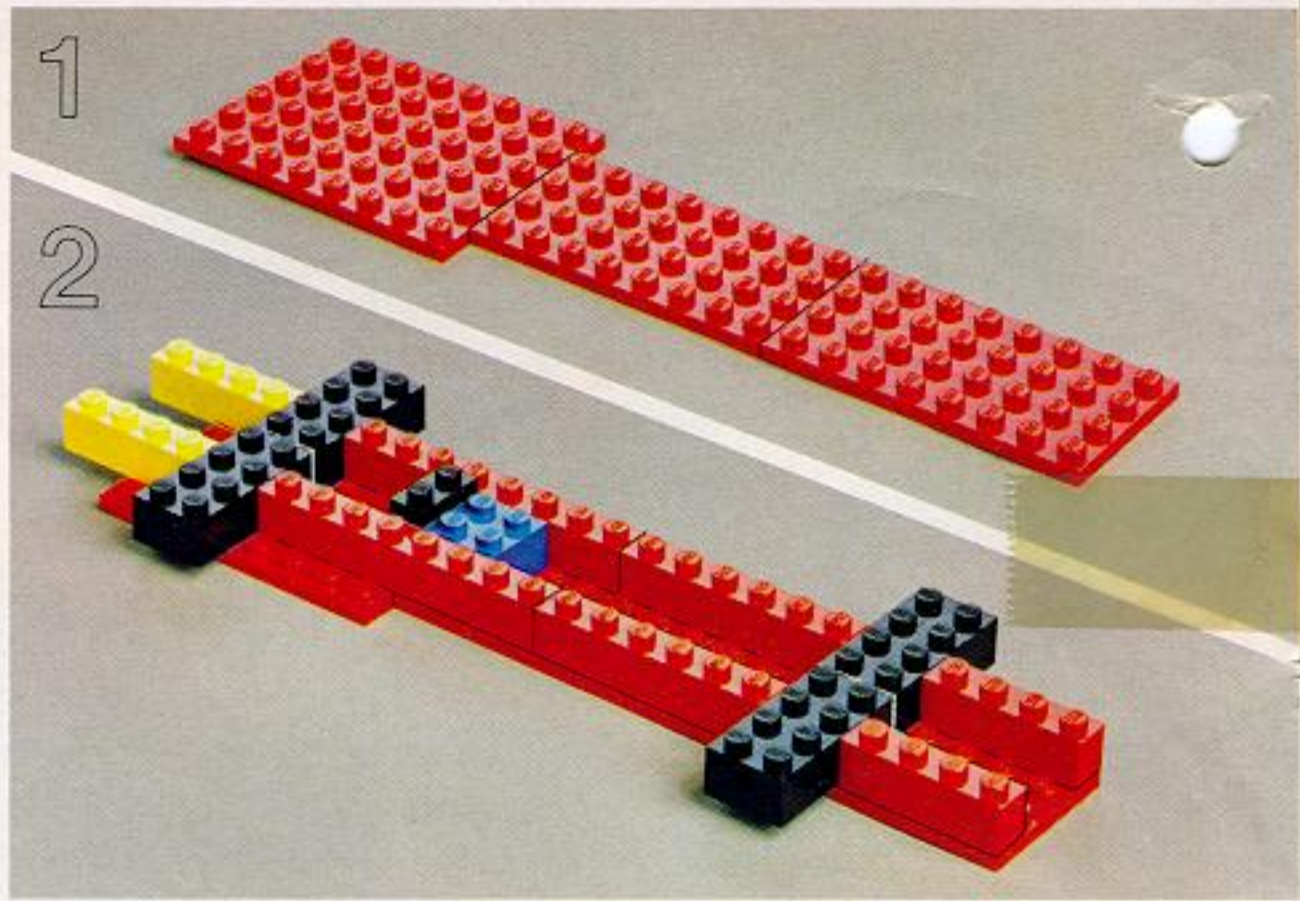

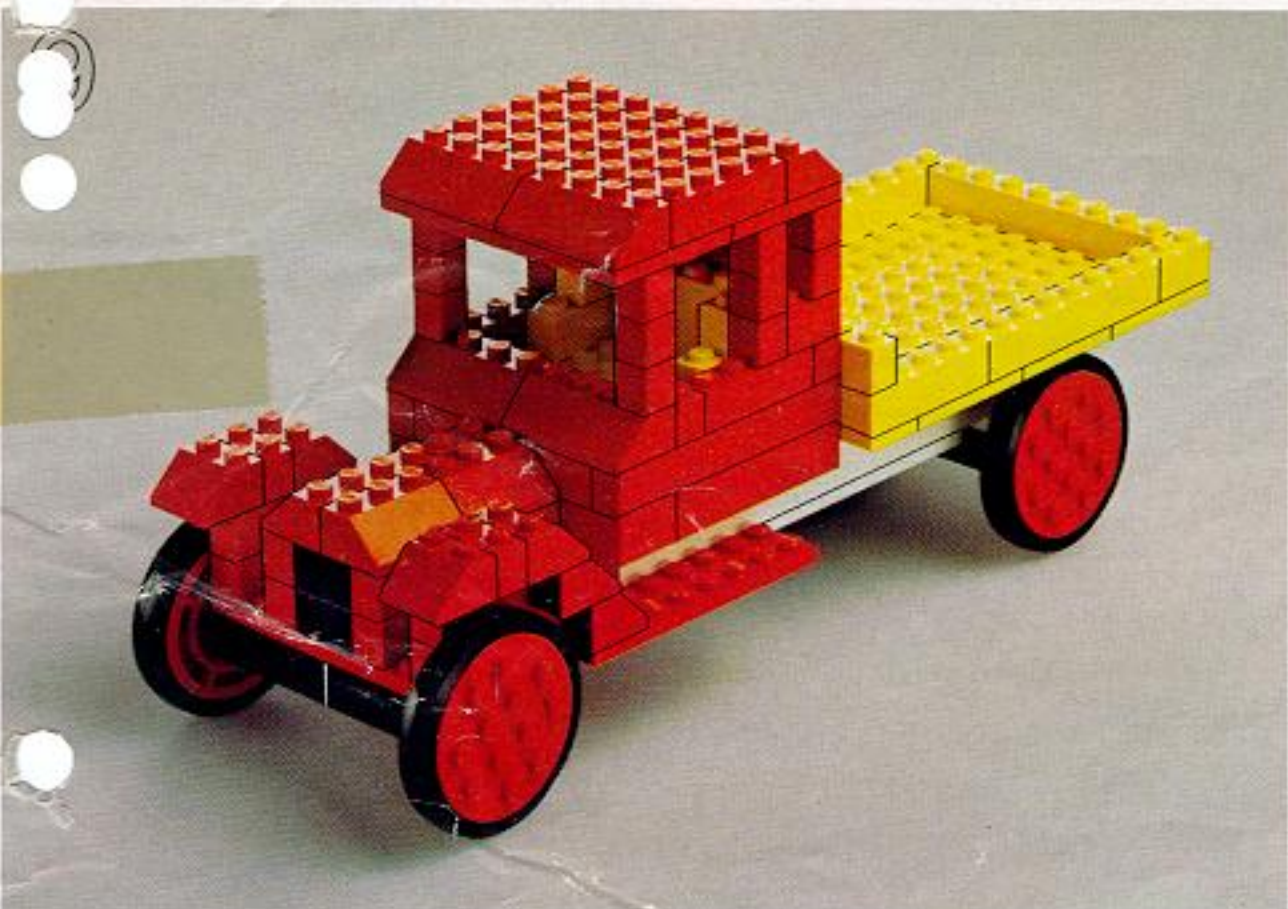
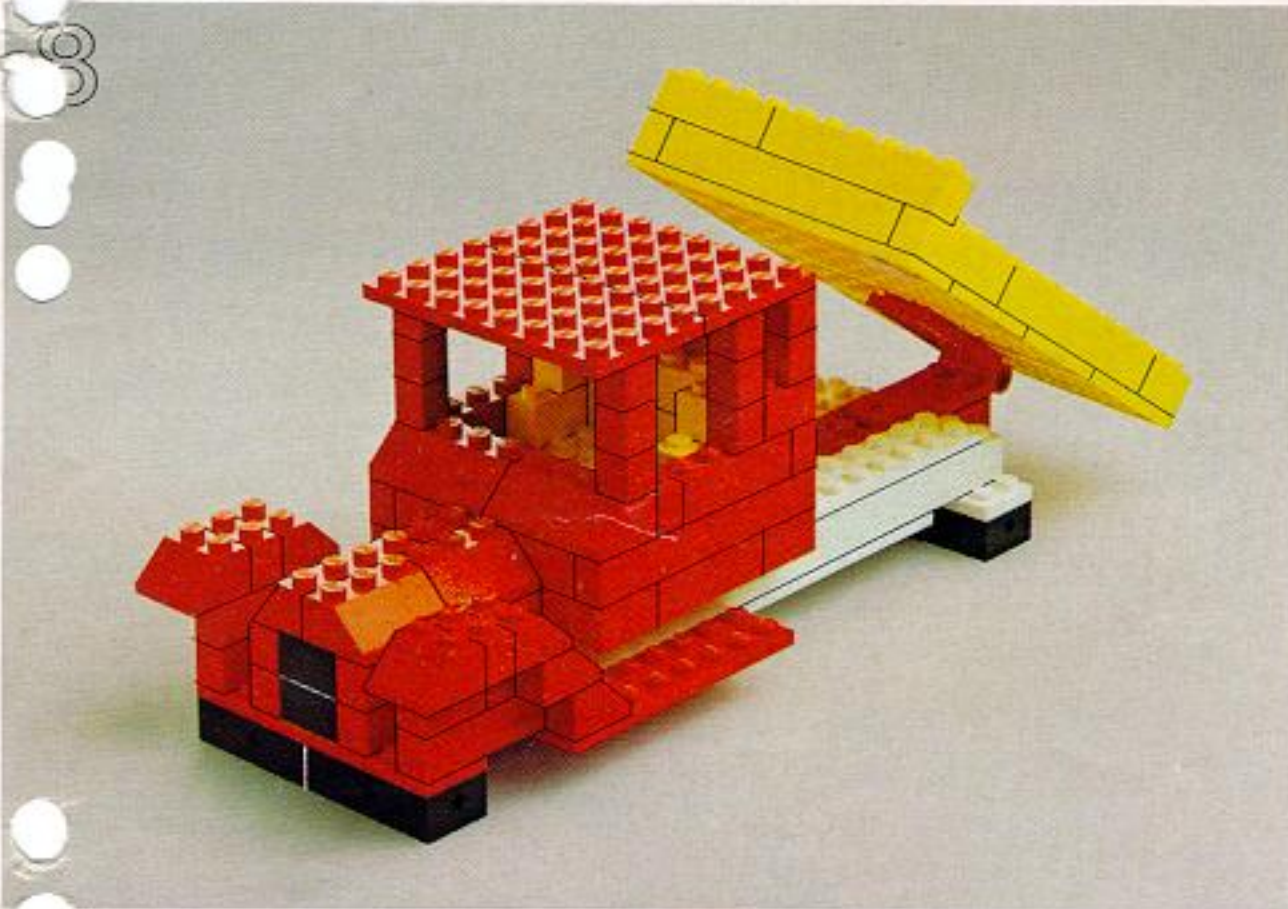

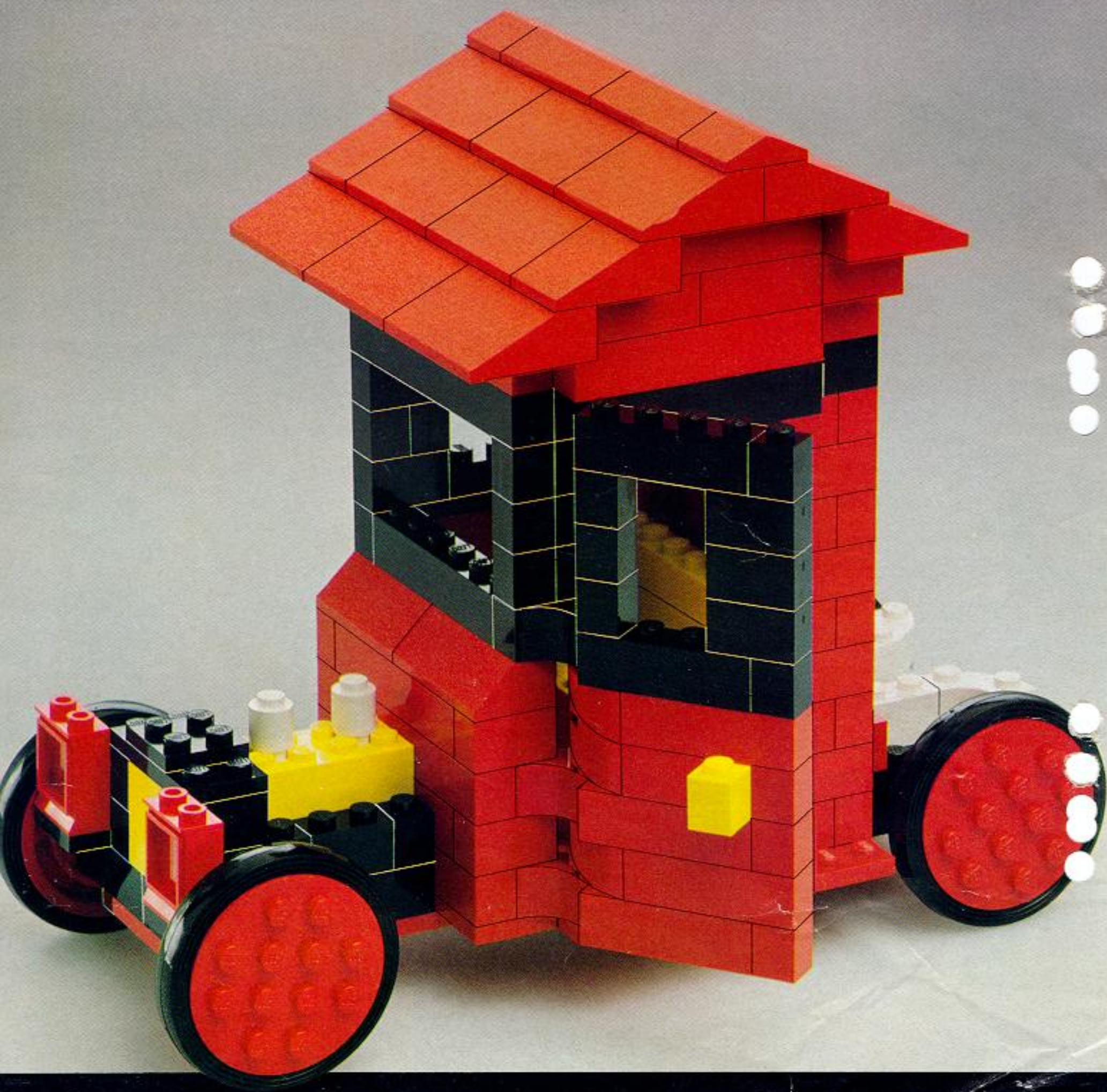

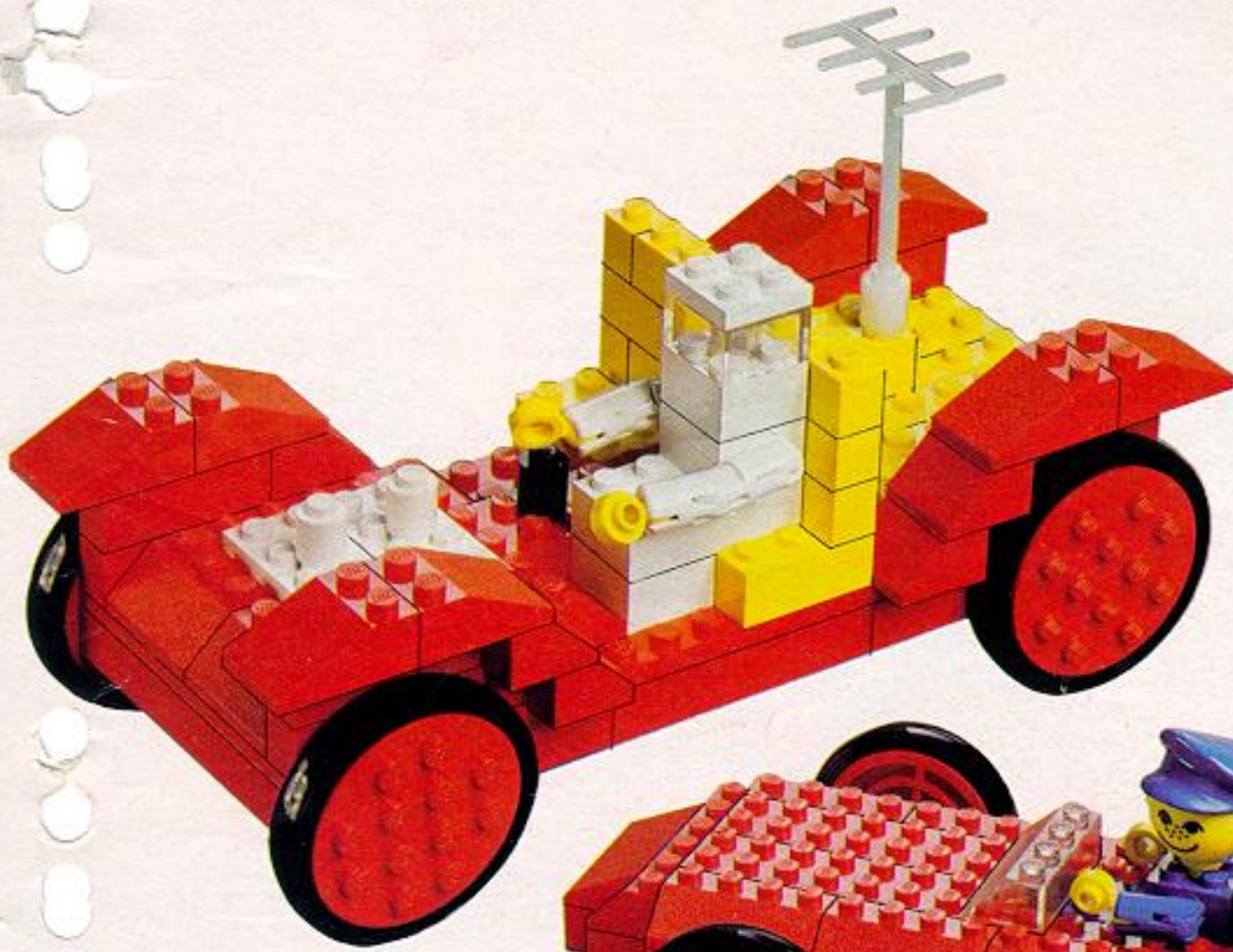
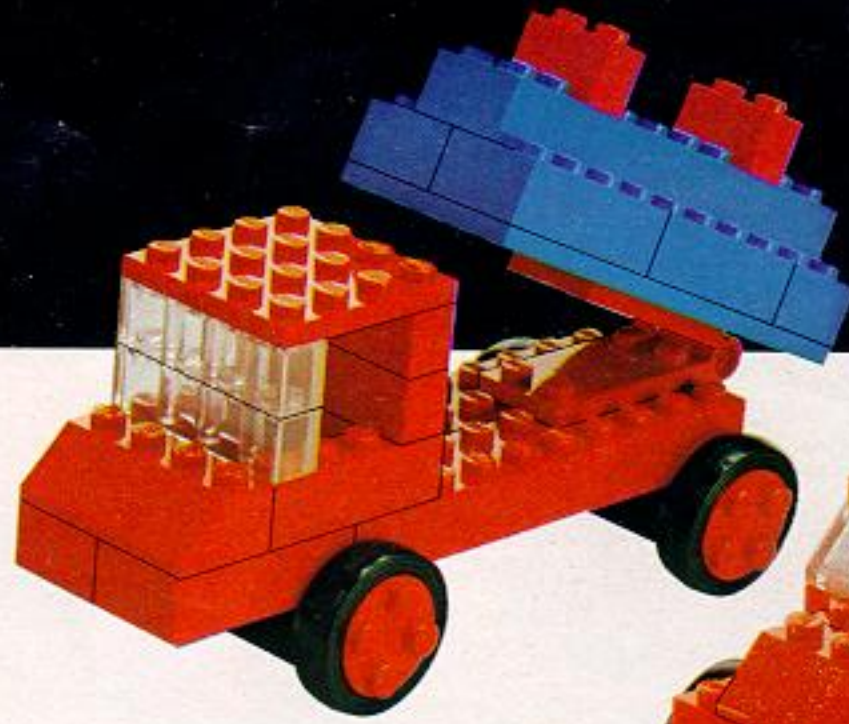

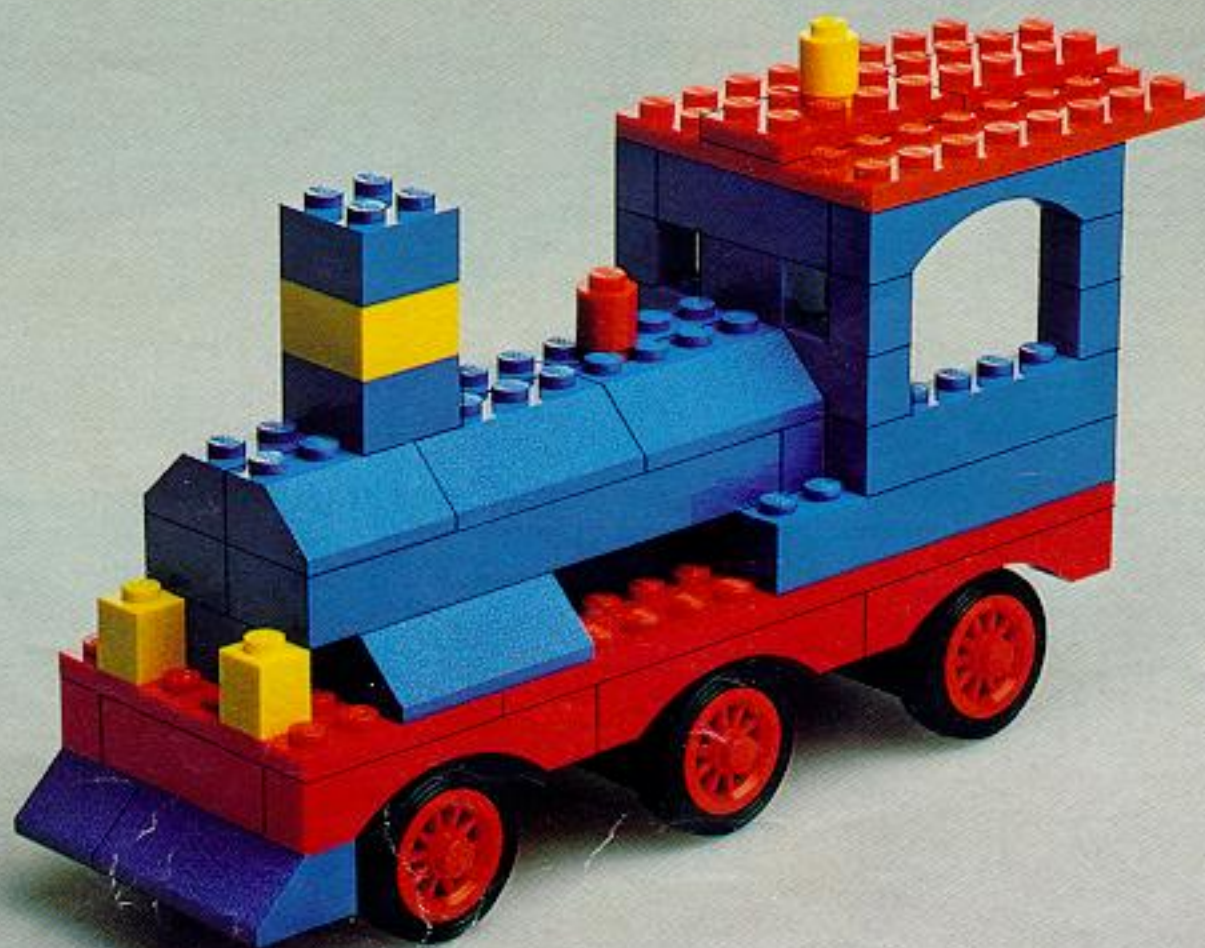
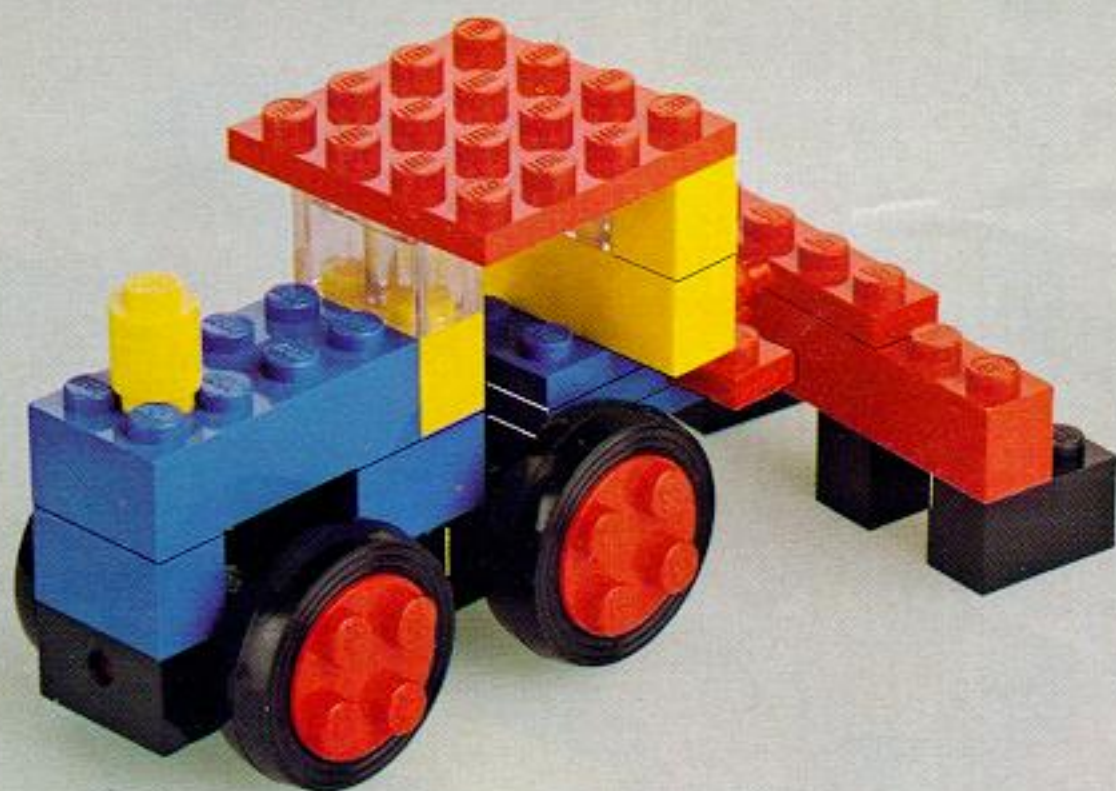
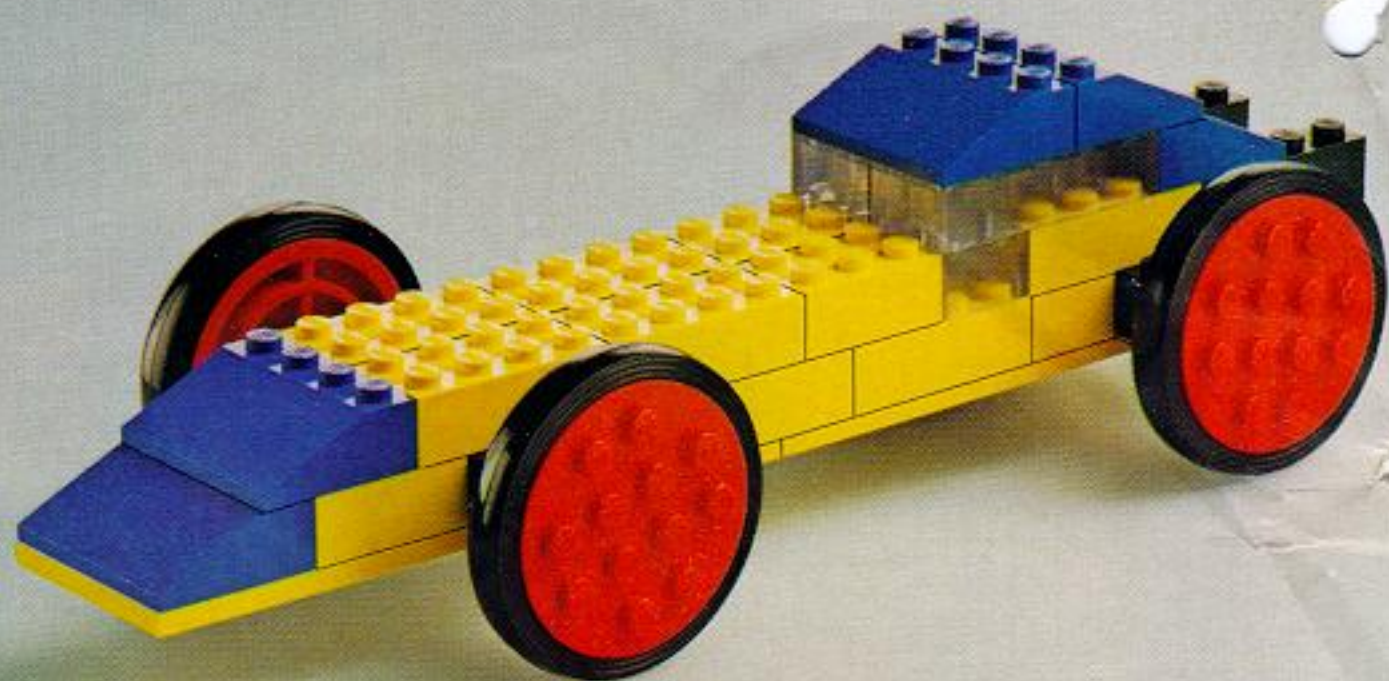

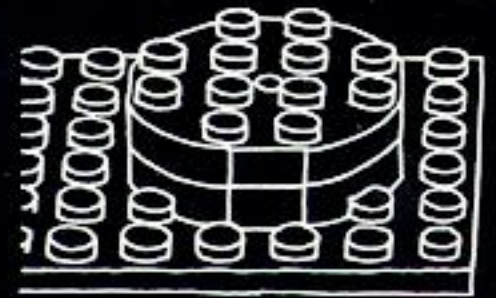
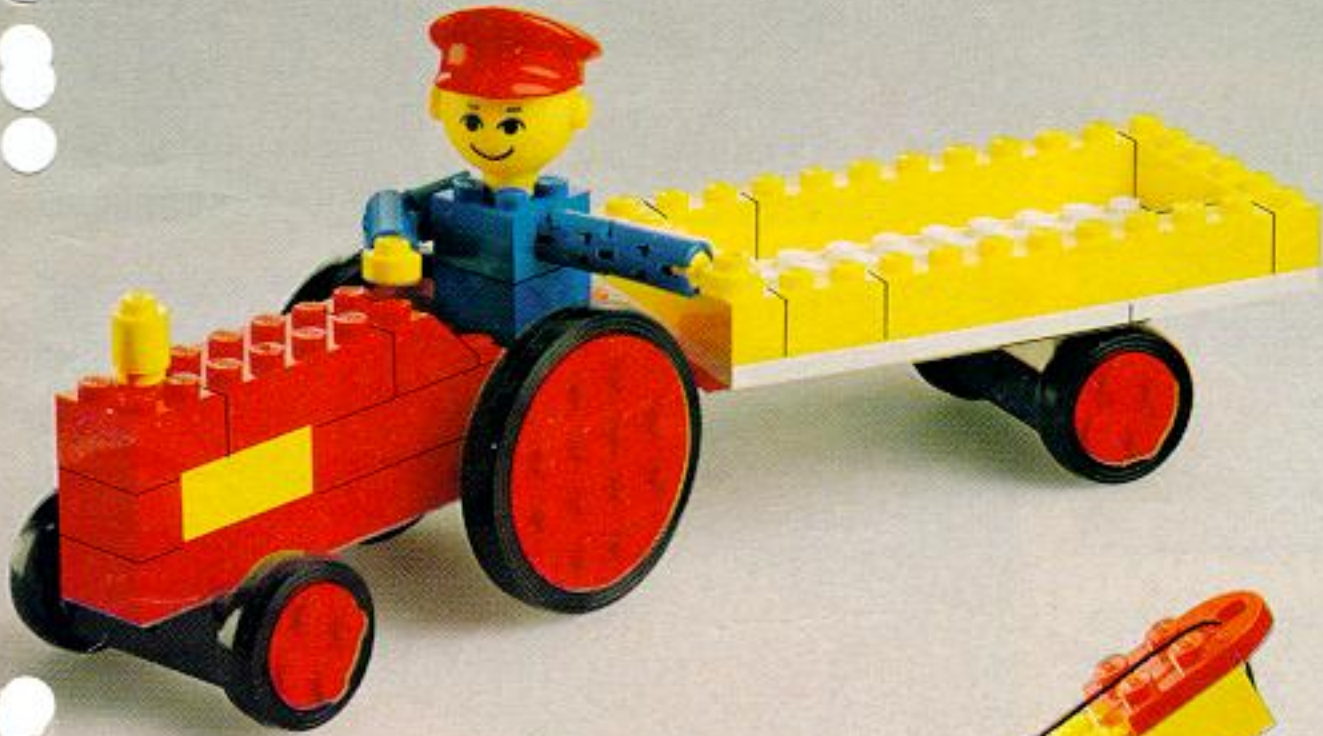

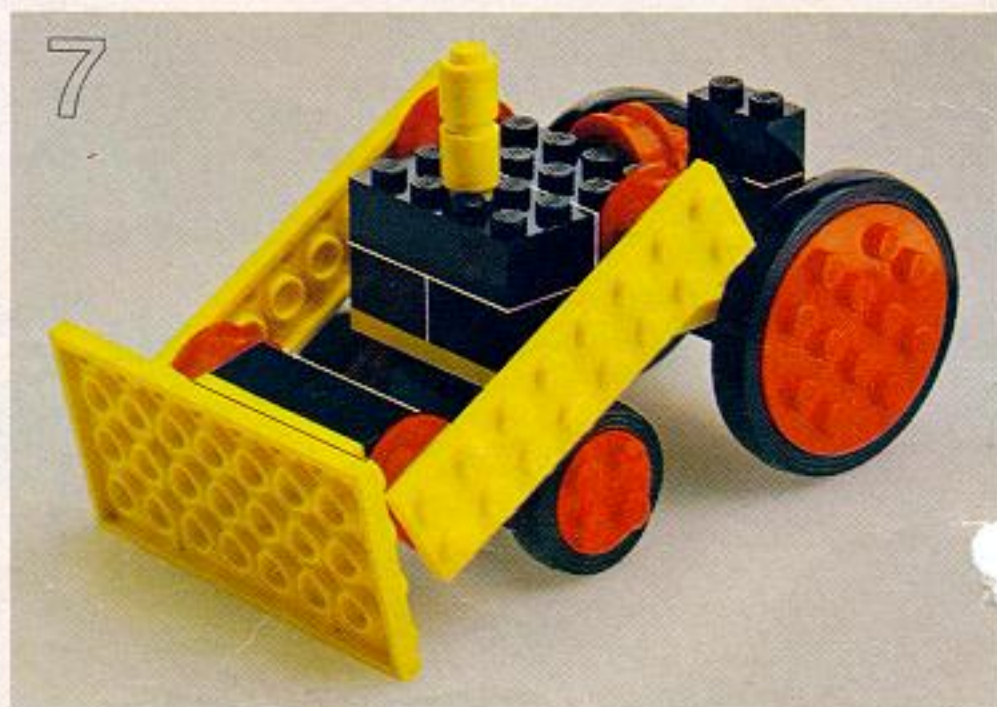
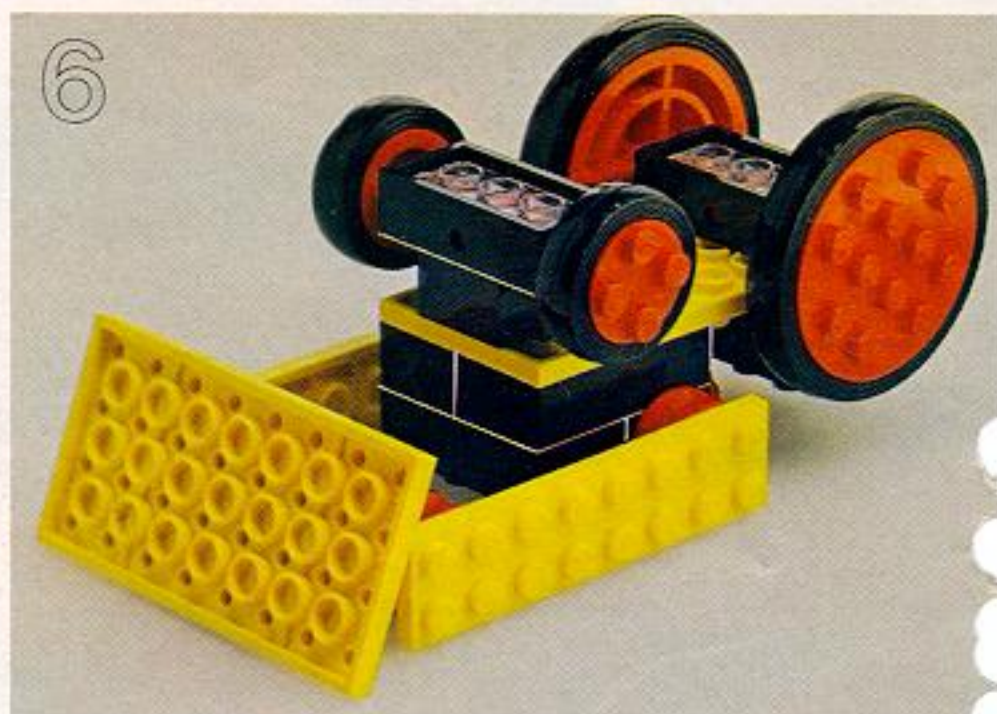
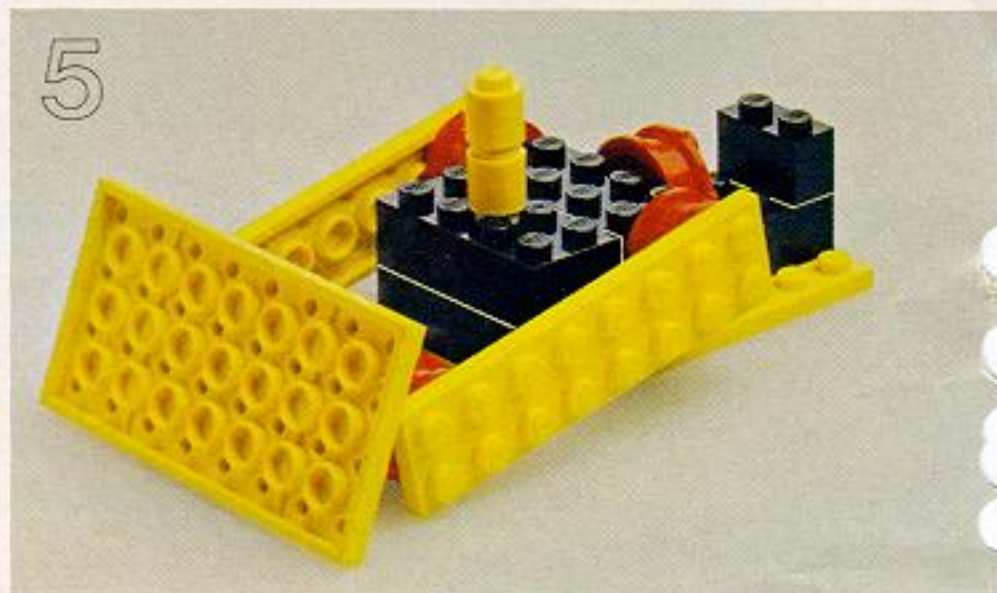
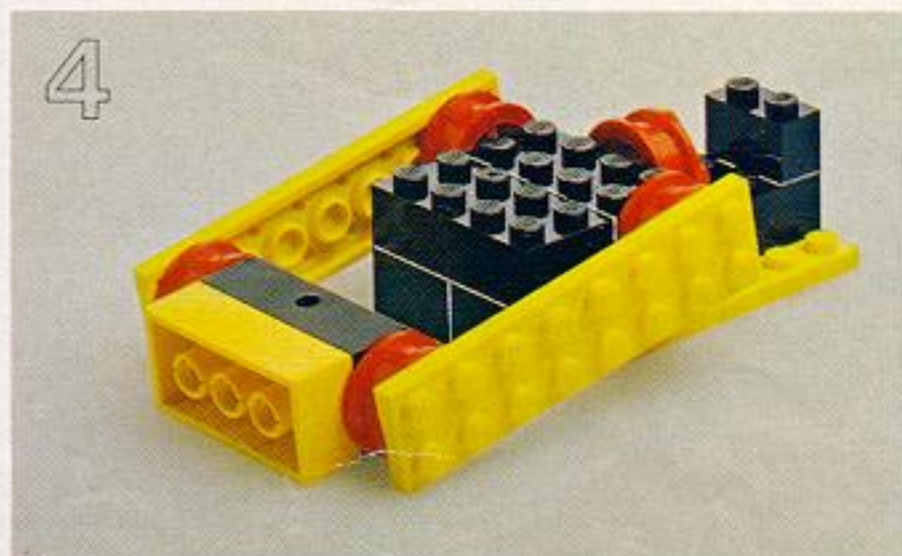
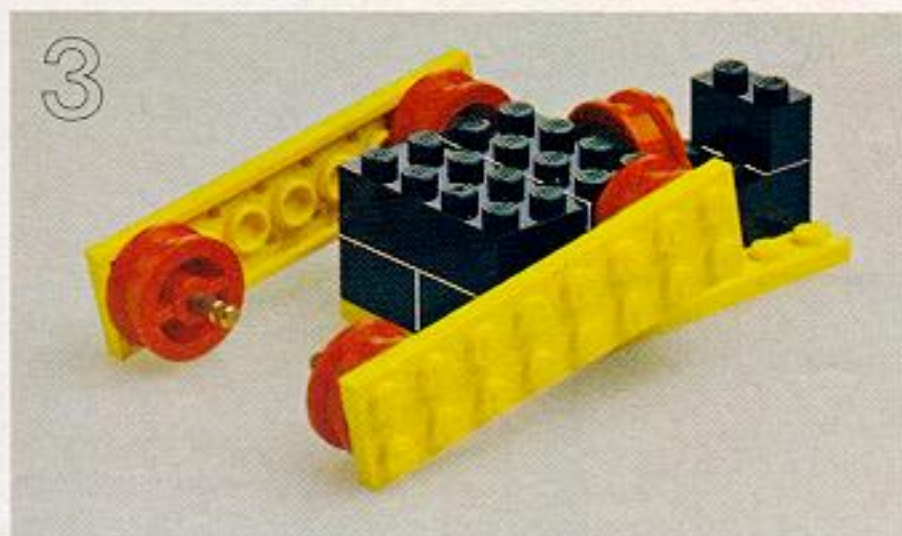
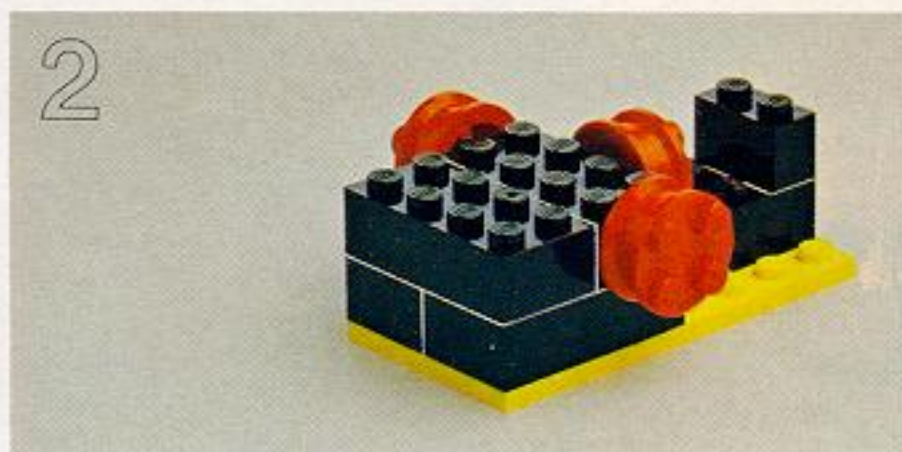
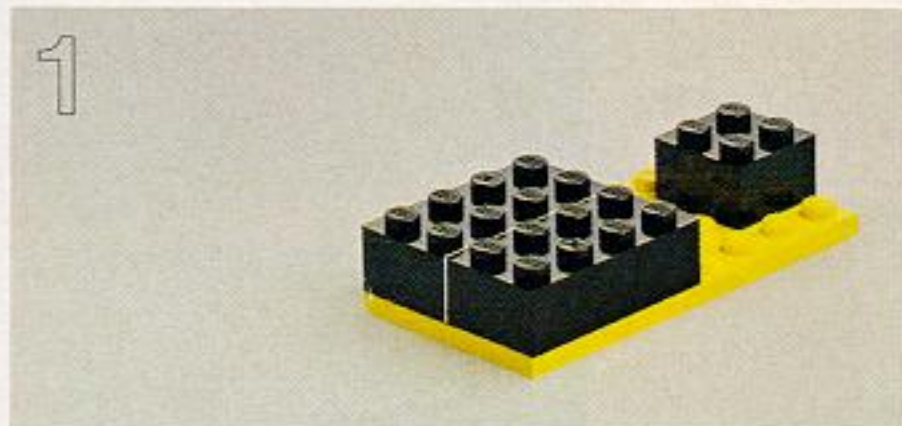

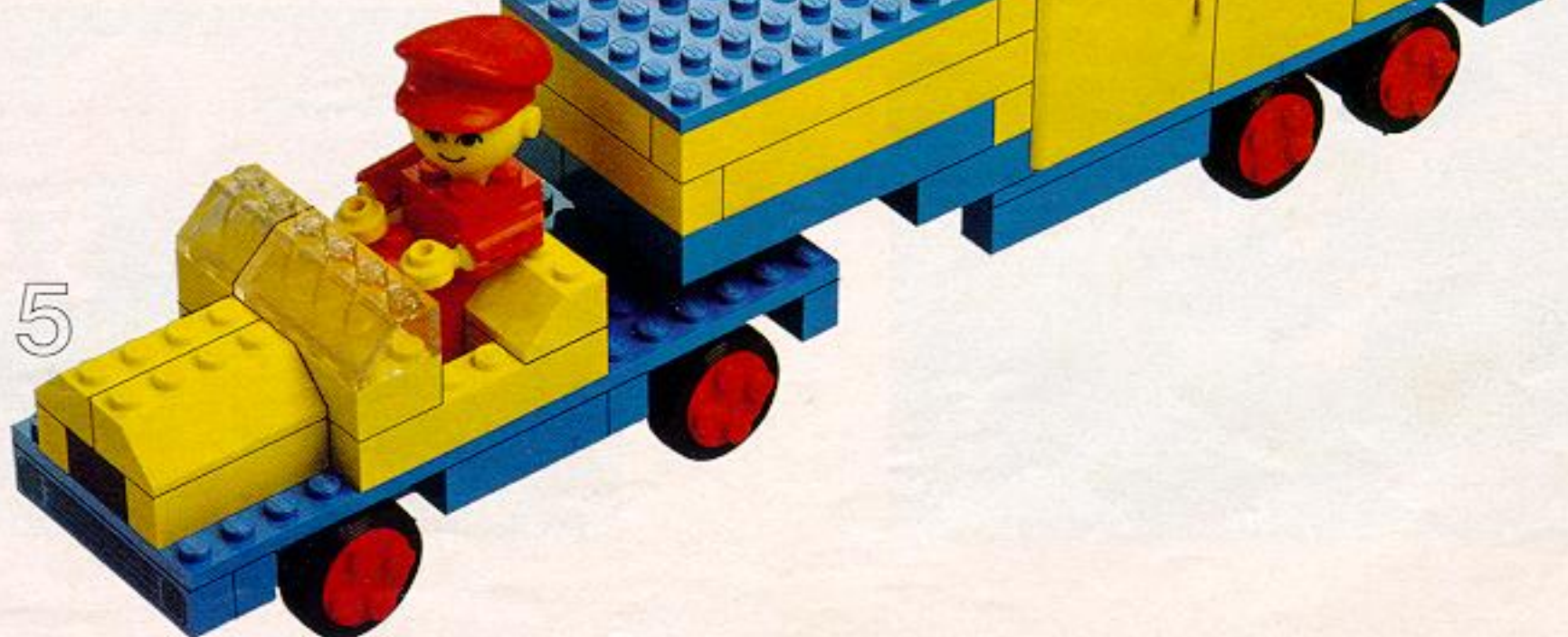
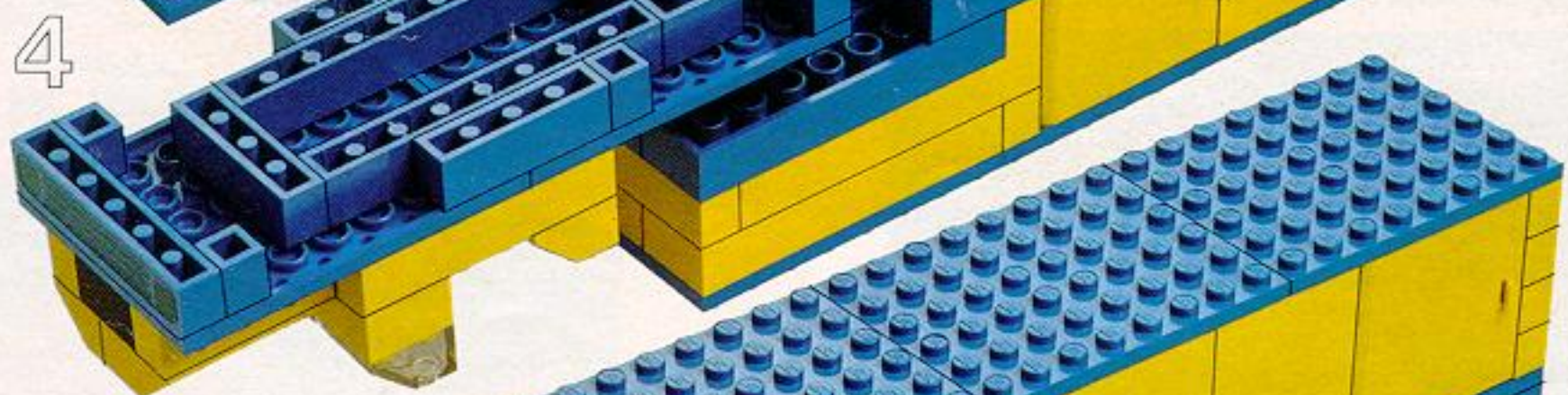
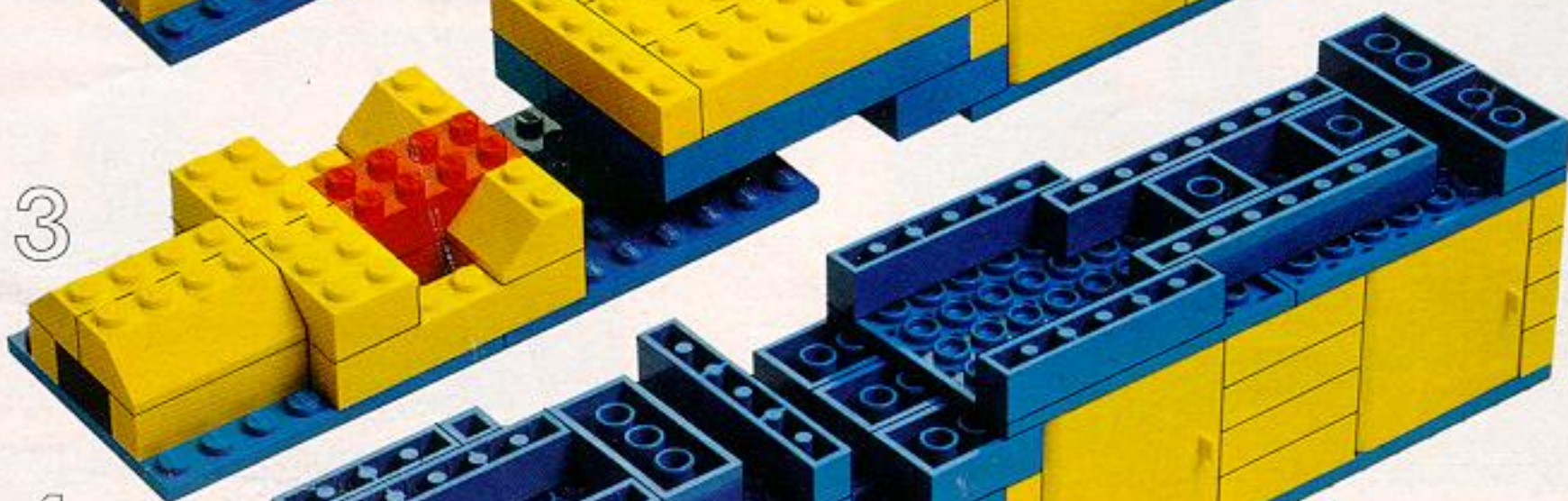
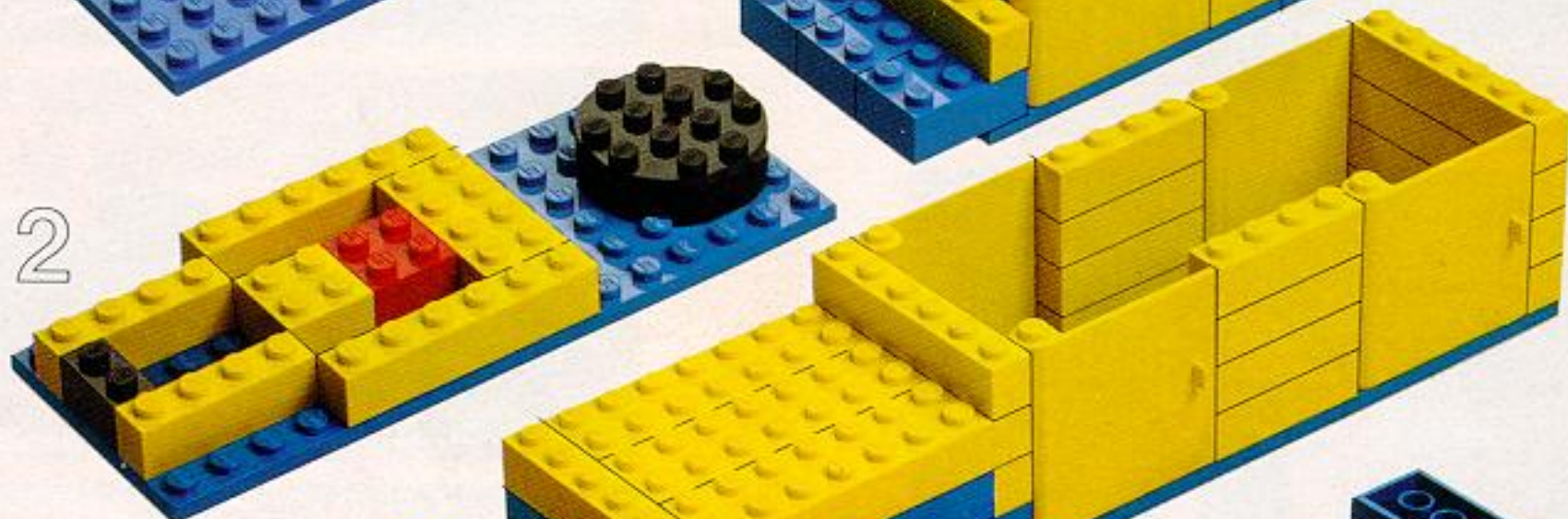
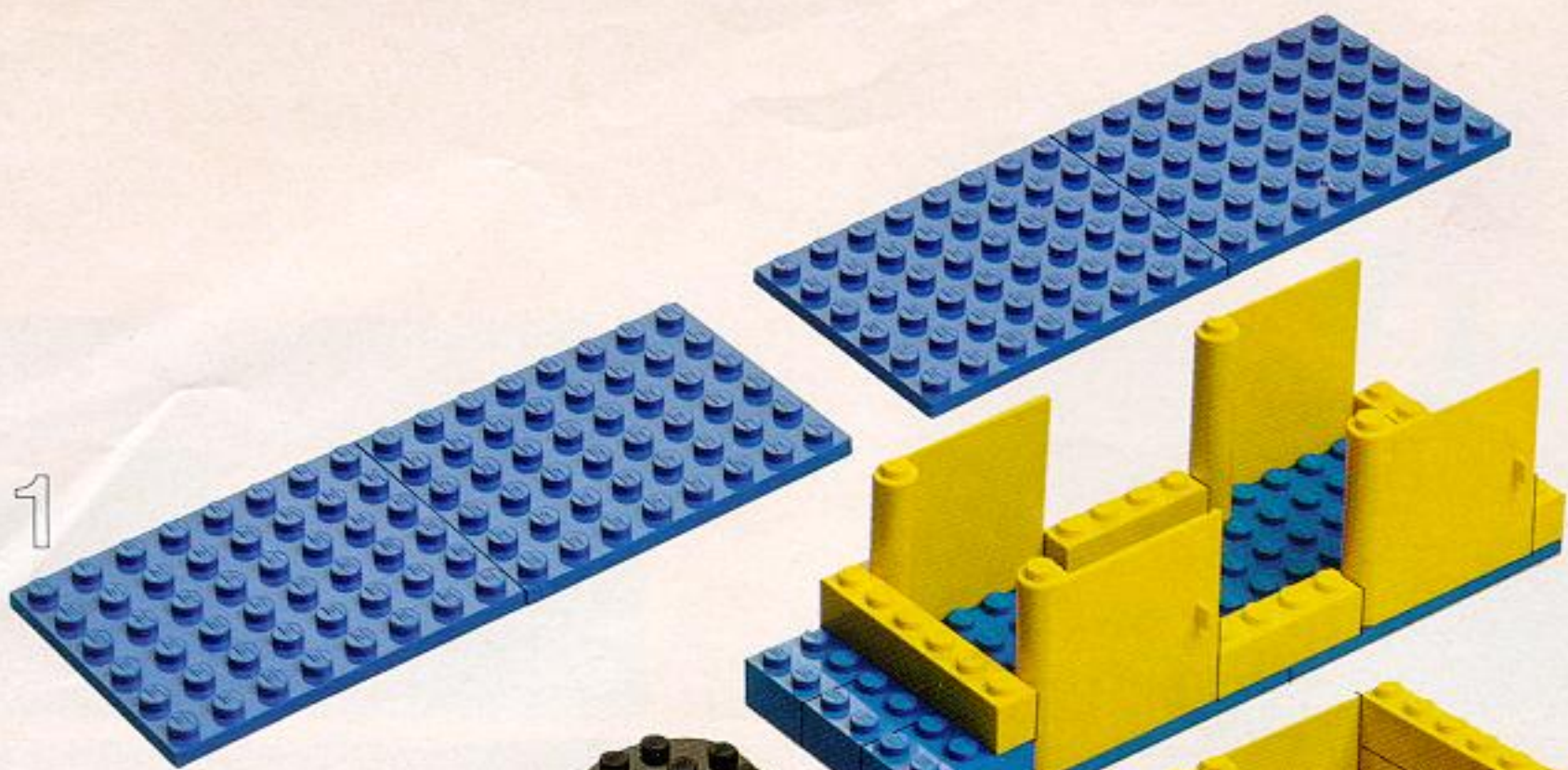

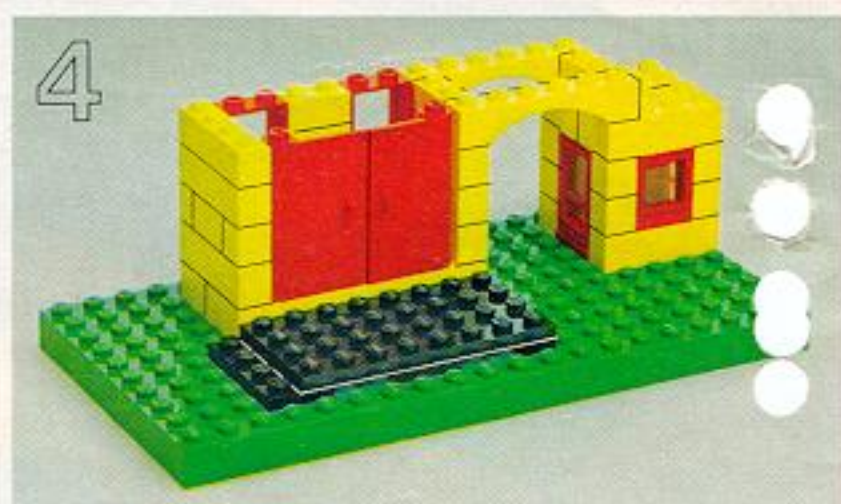
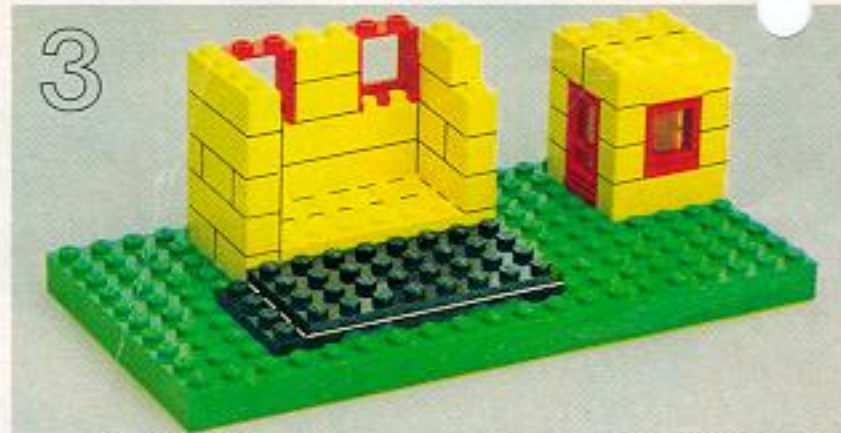
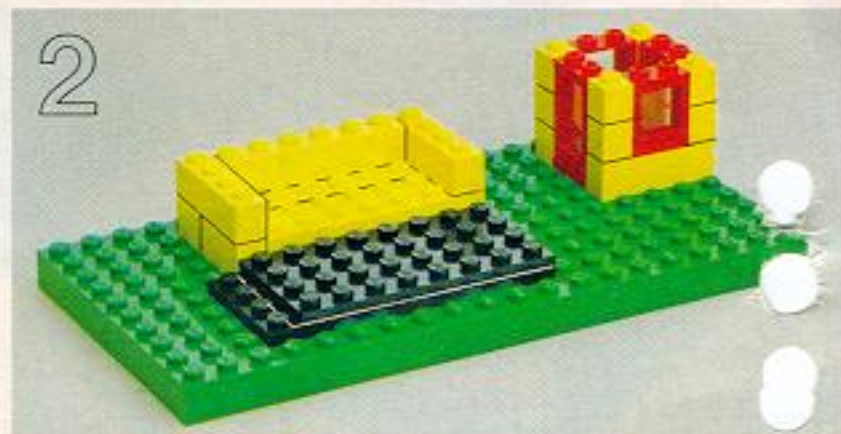
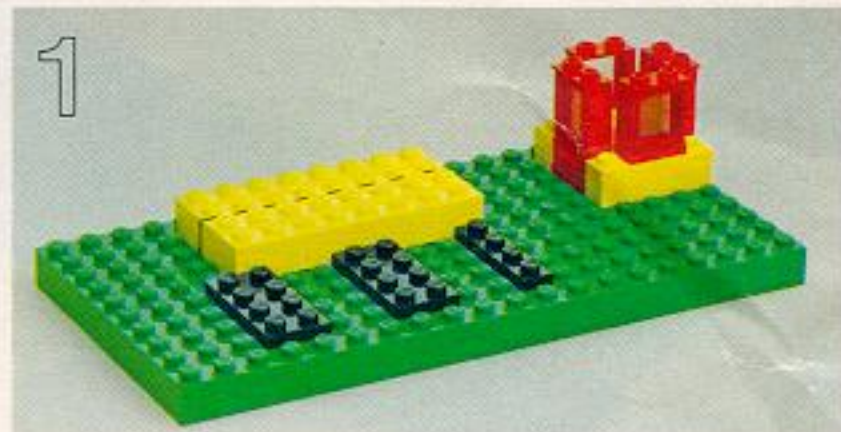

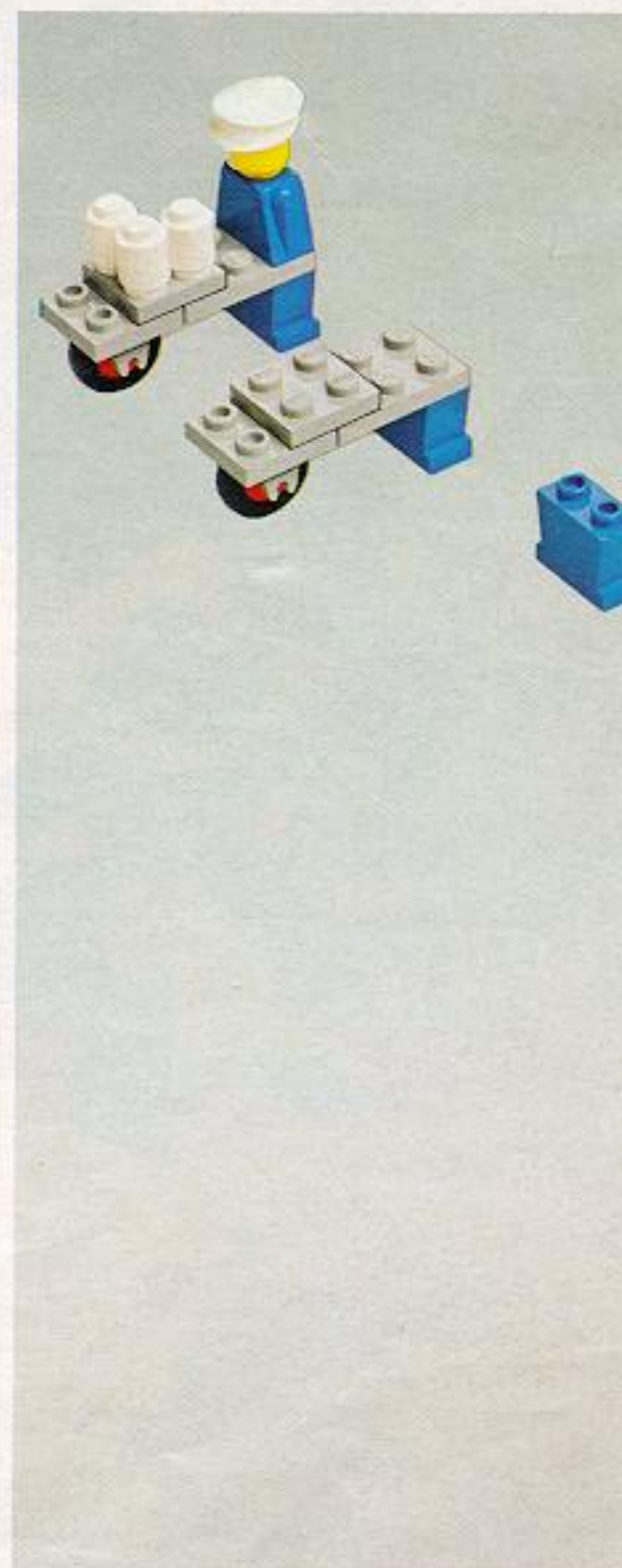
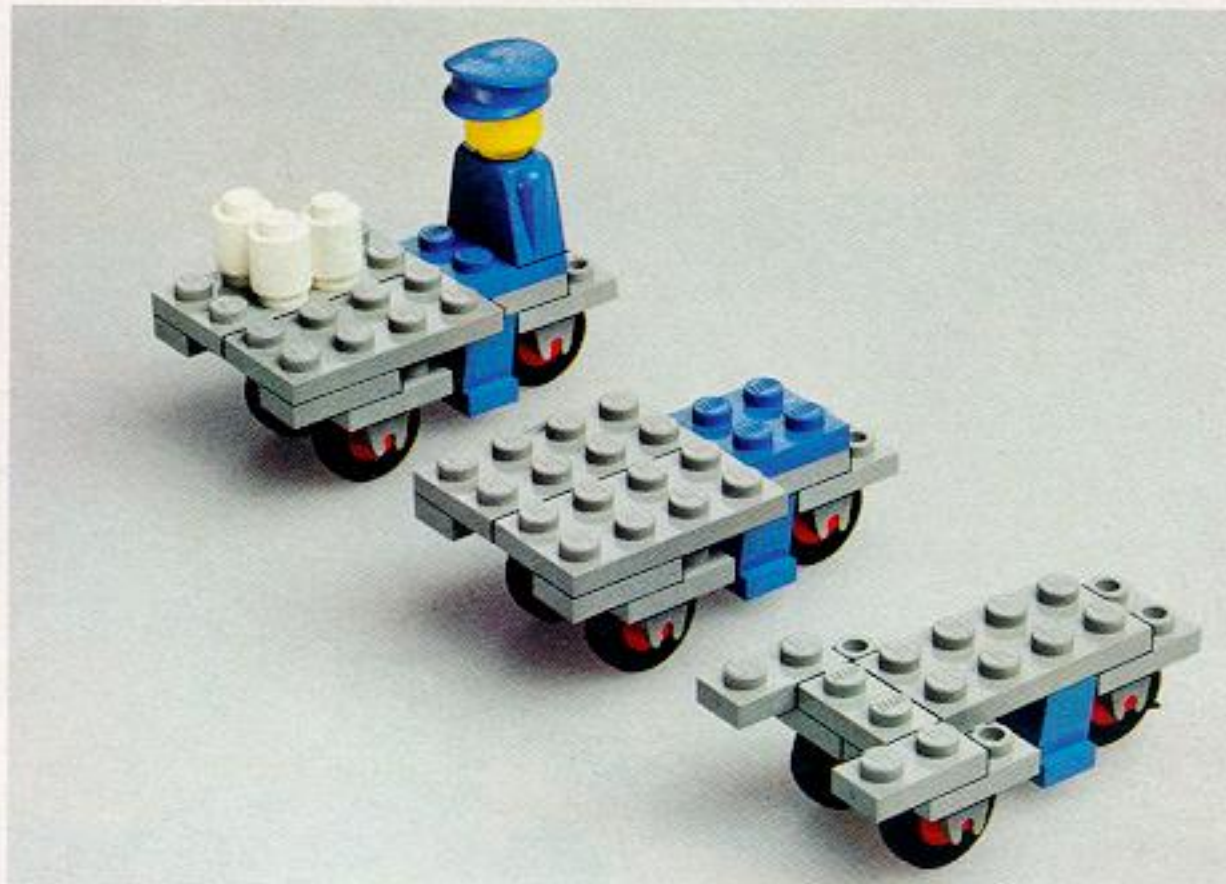

61





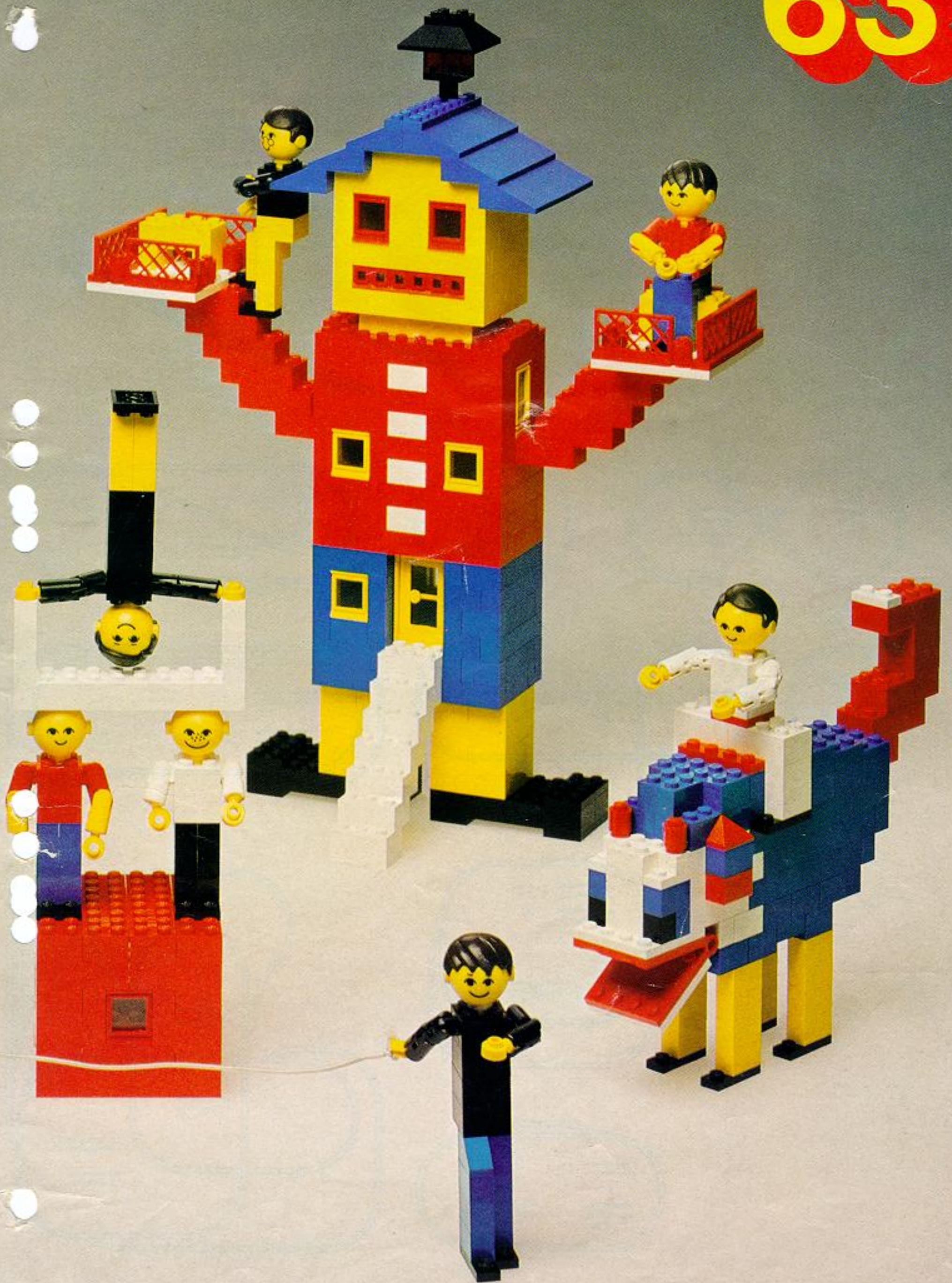

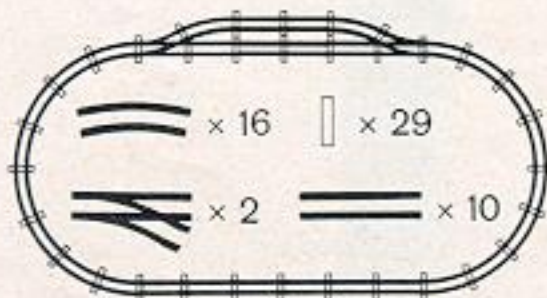
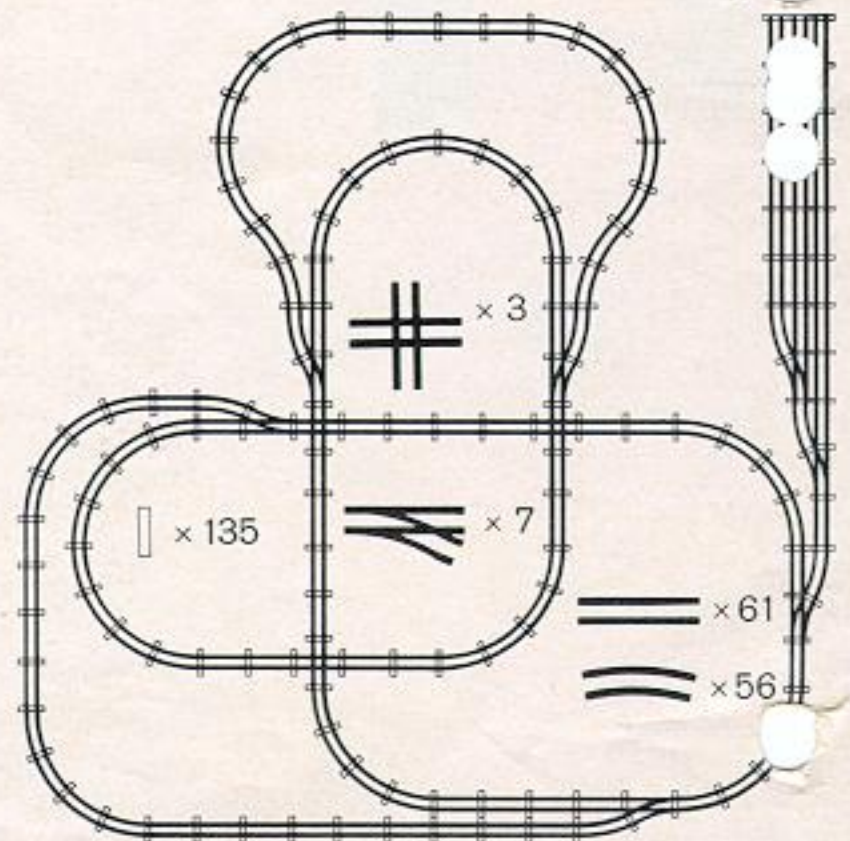
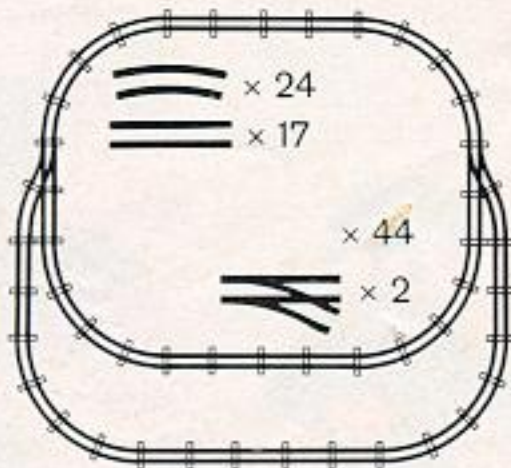
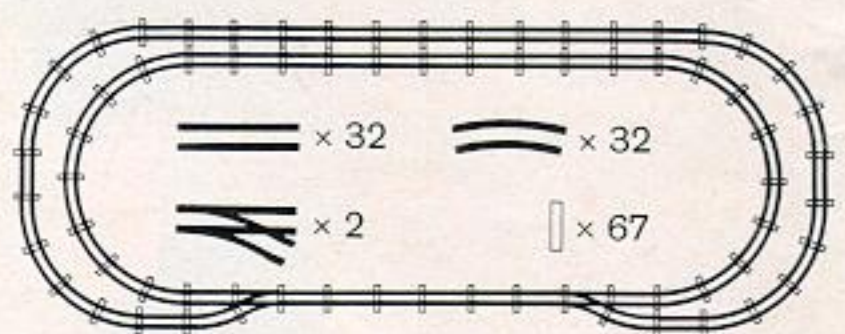
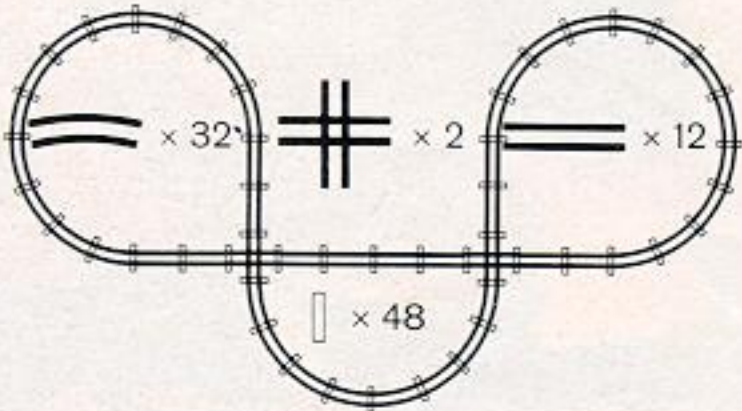
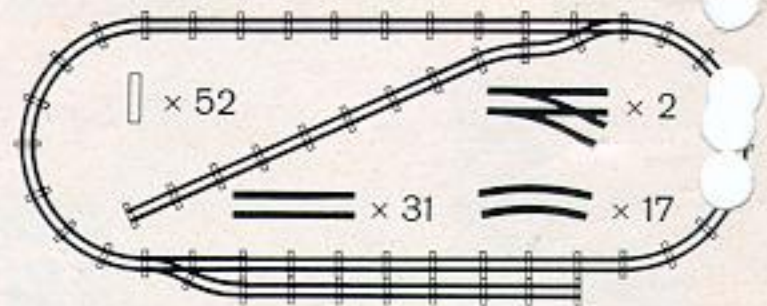
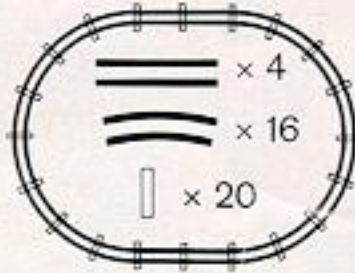
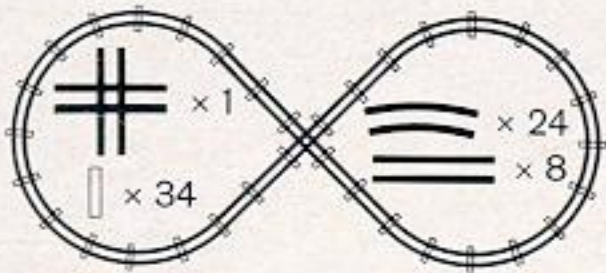
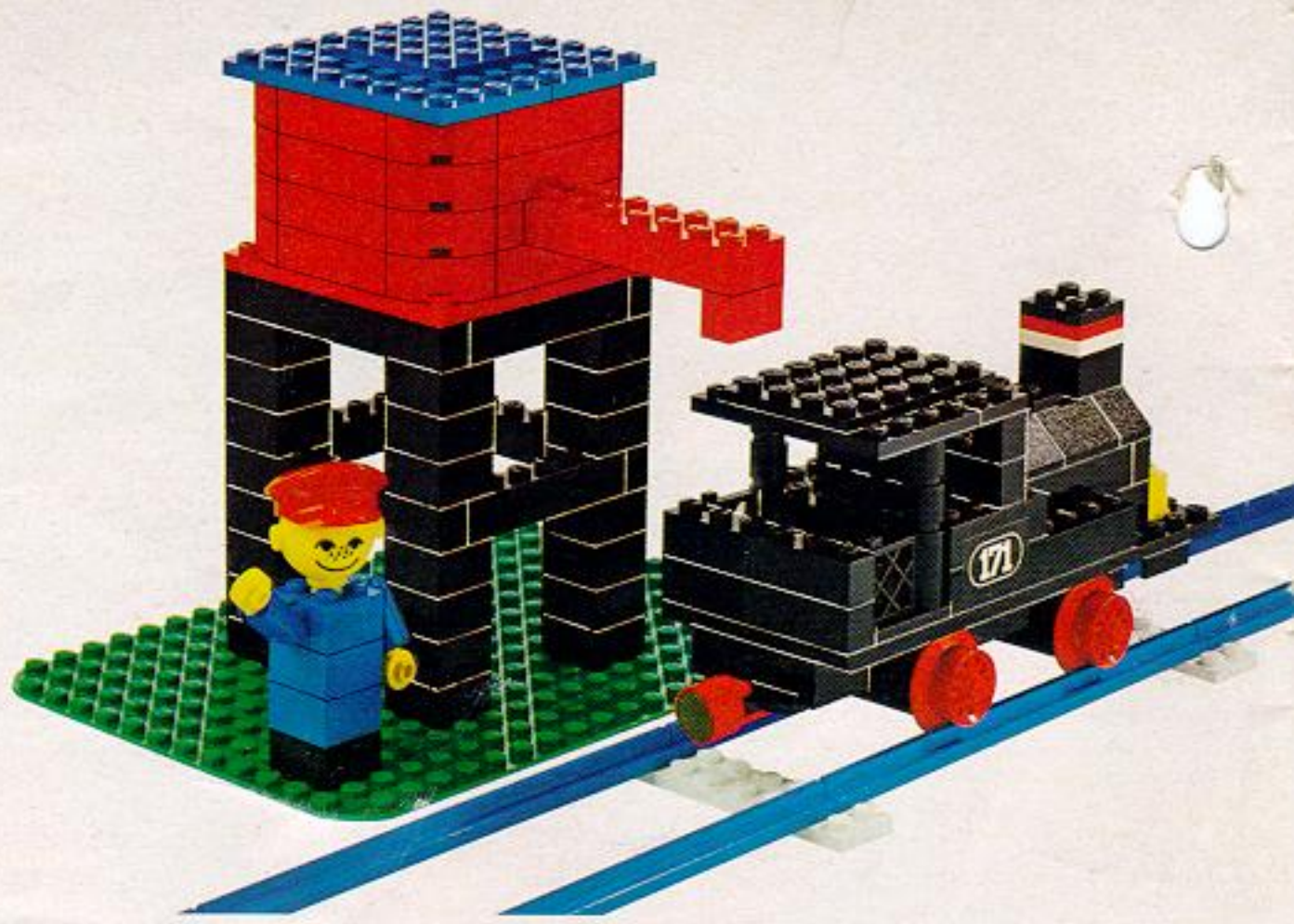

65

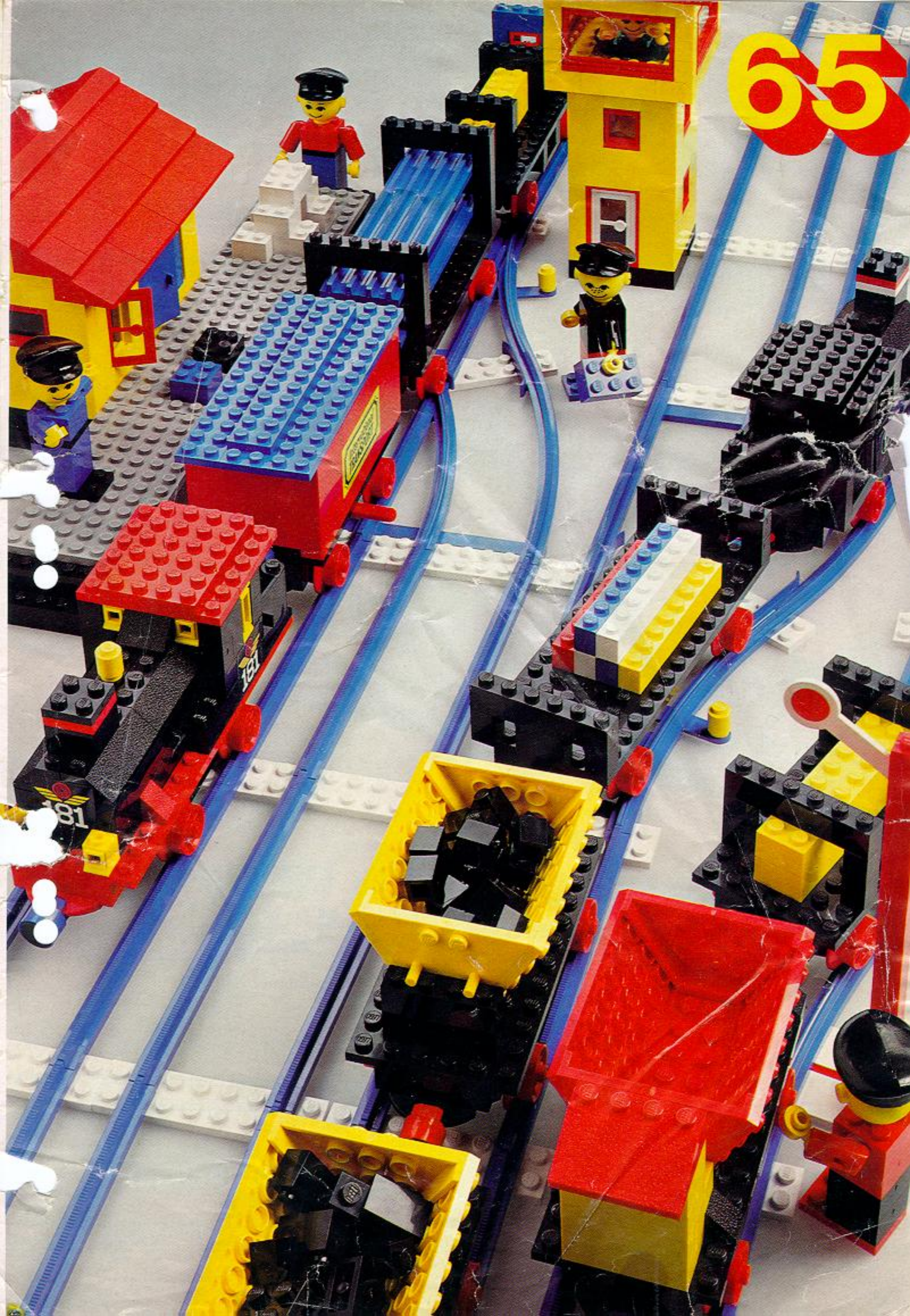

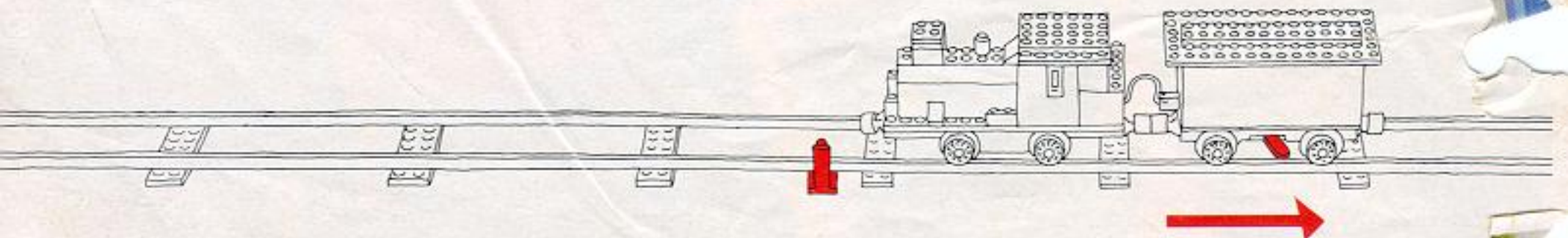
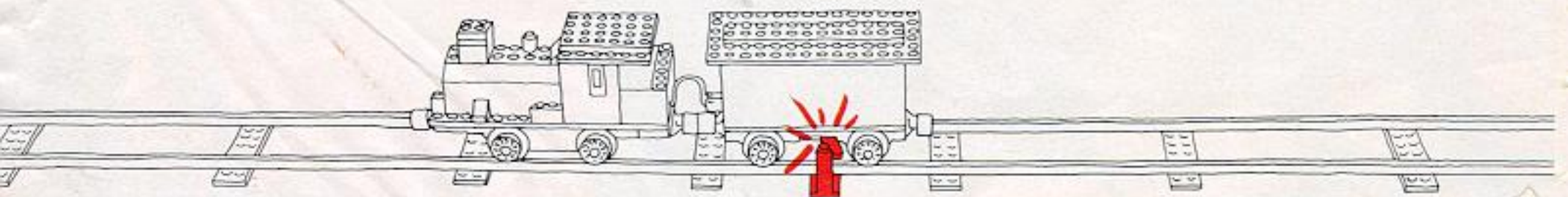
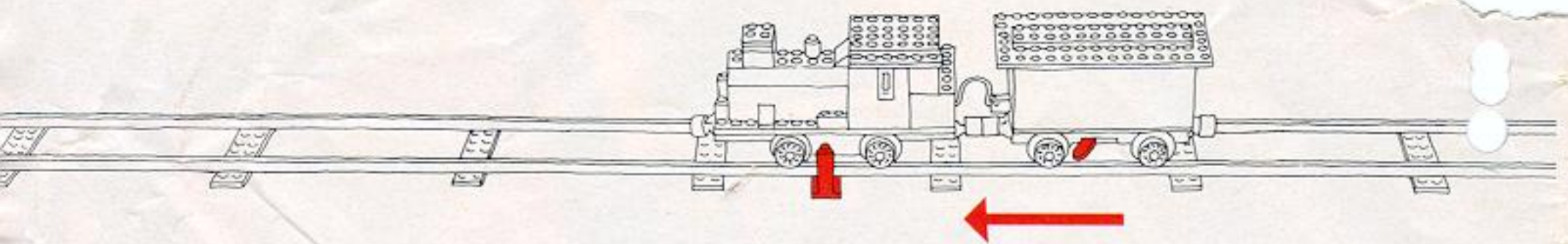
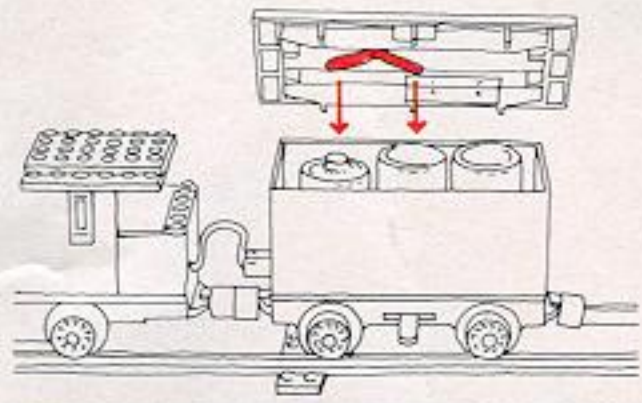

67

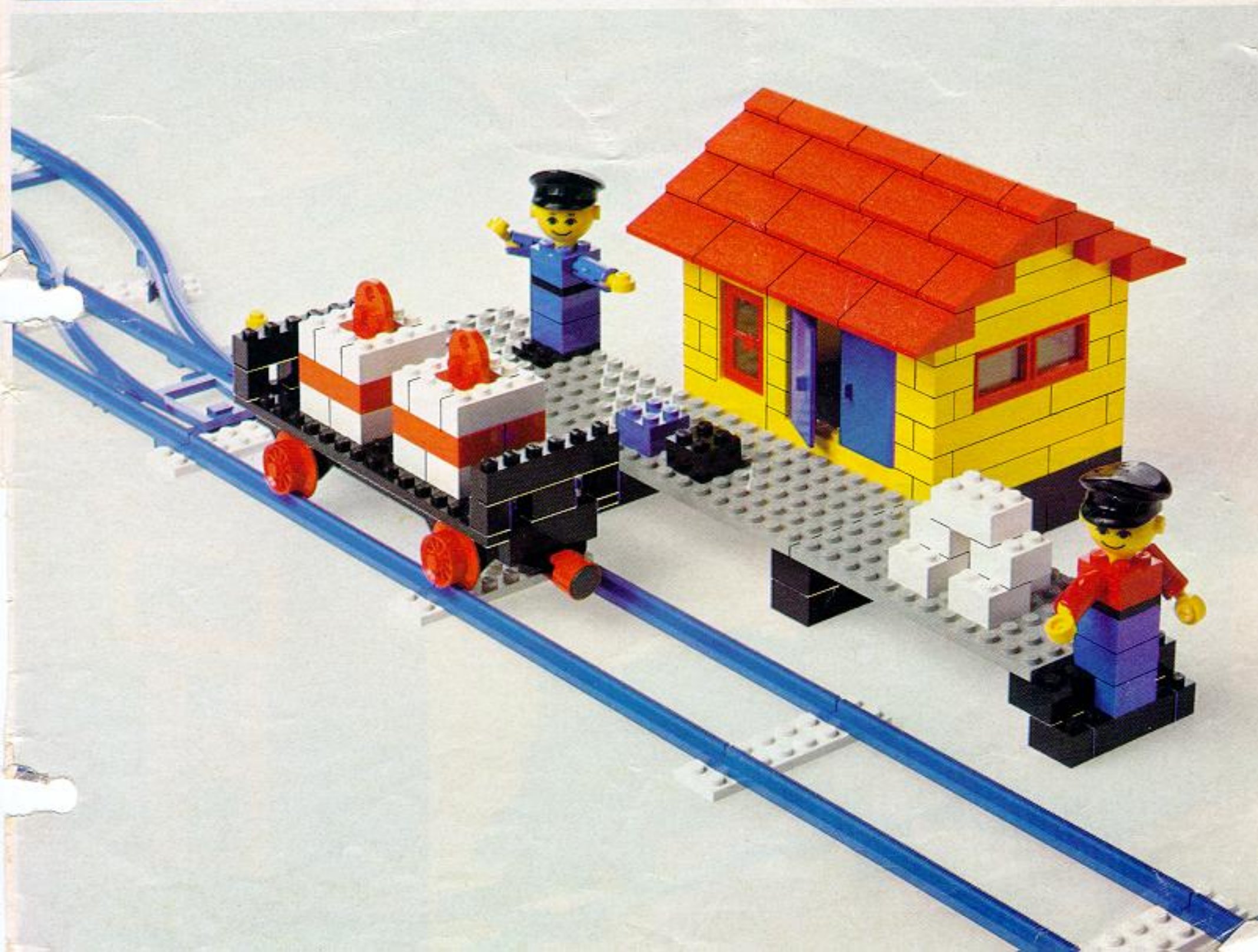

68

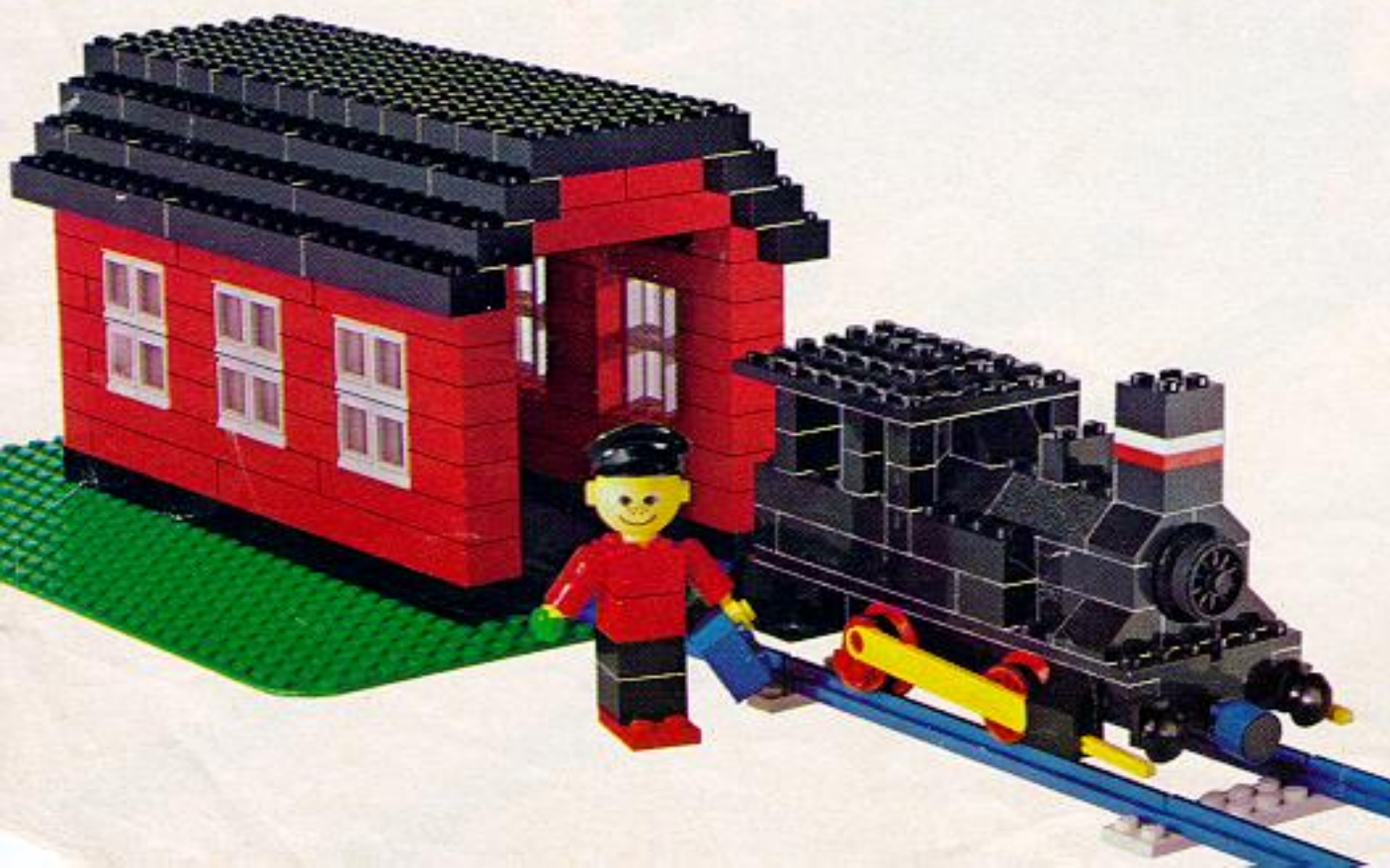

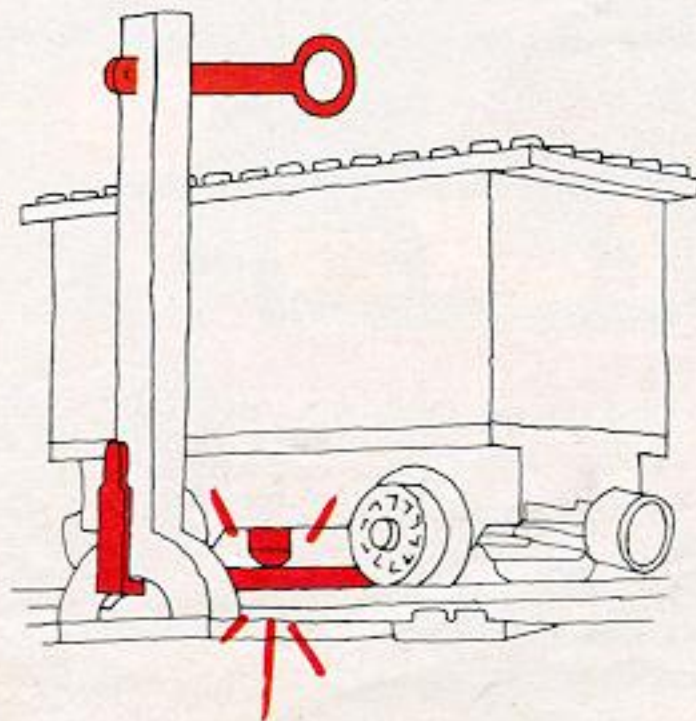
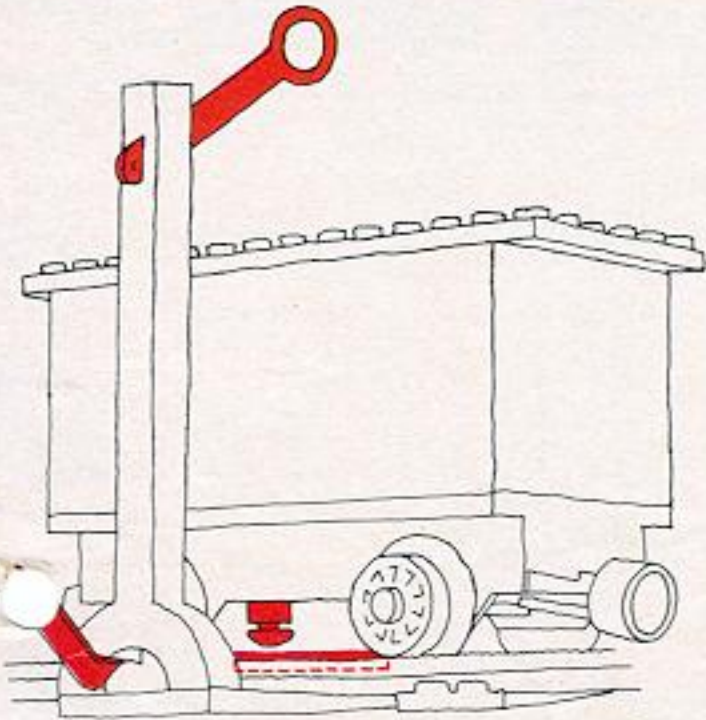
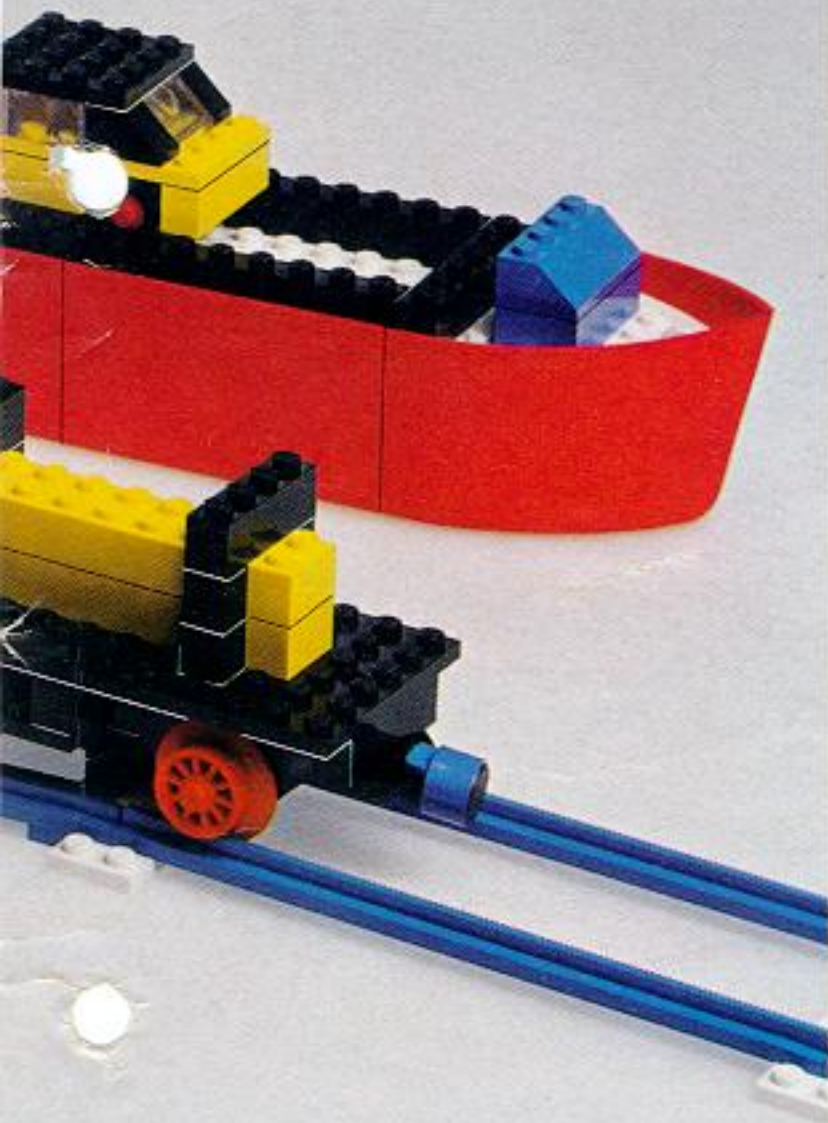

70



13

68

68

69

68

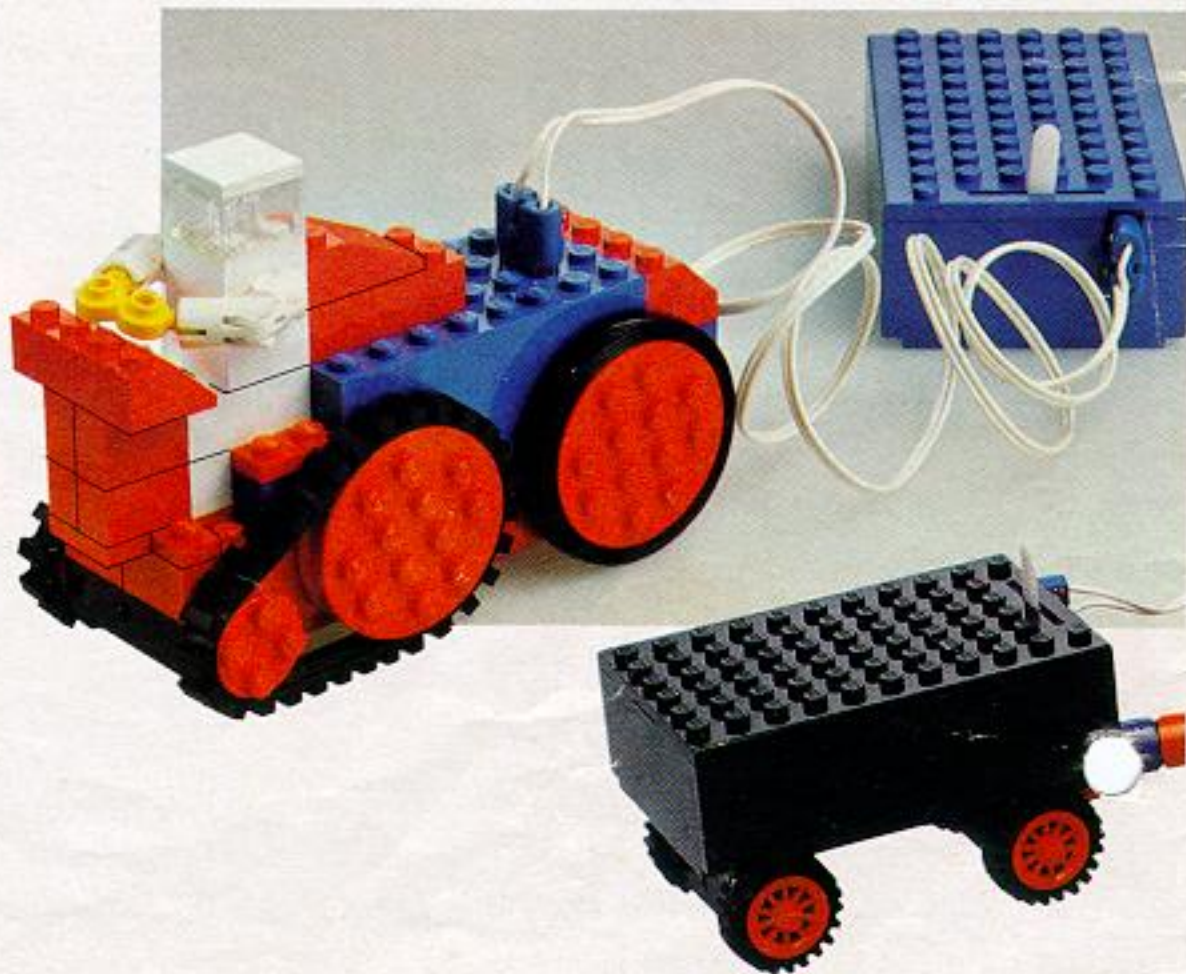
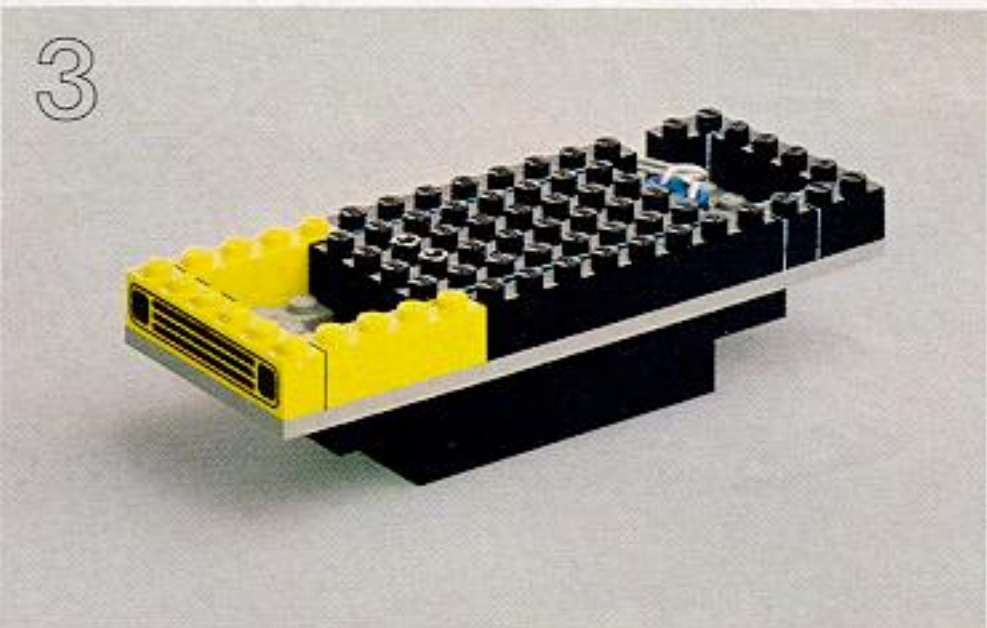
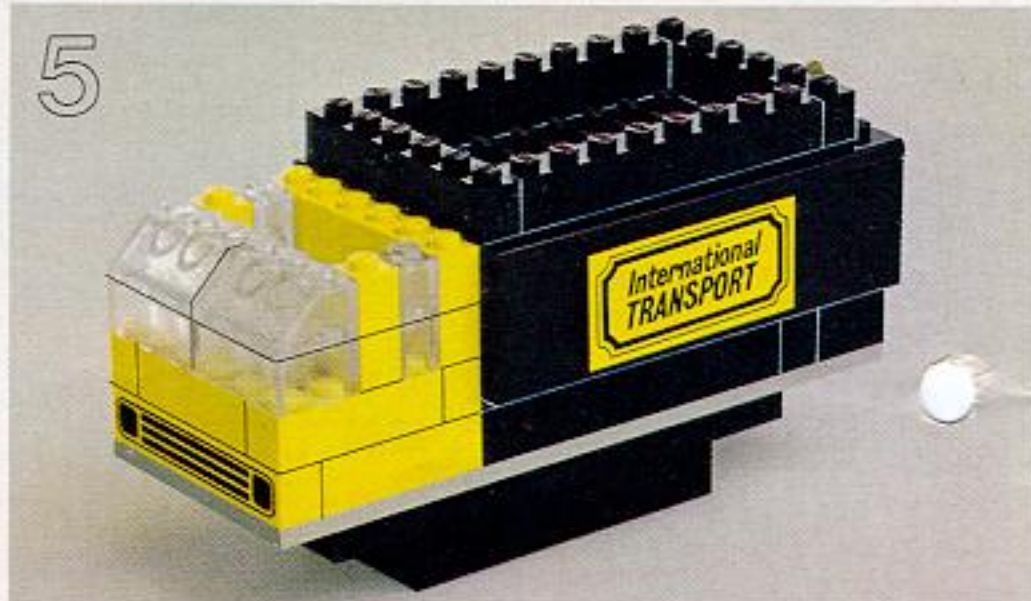
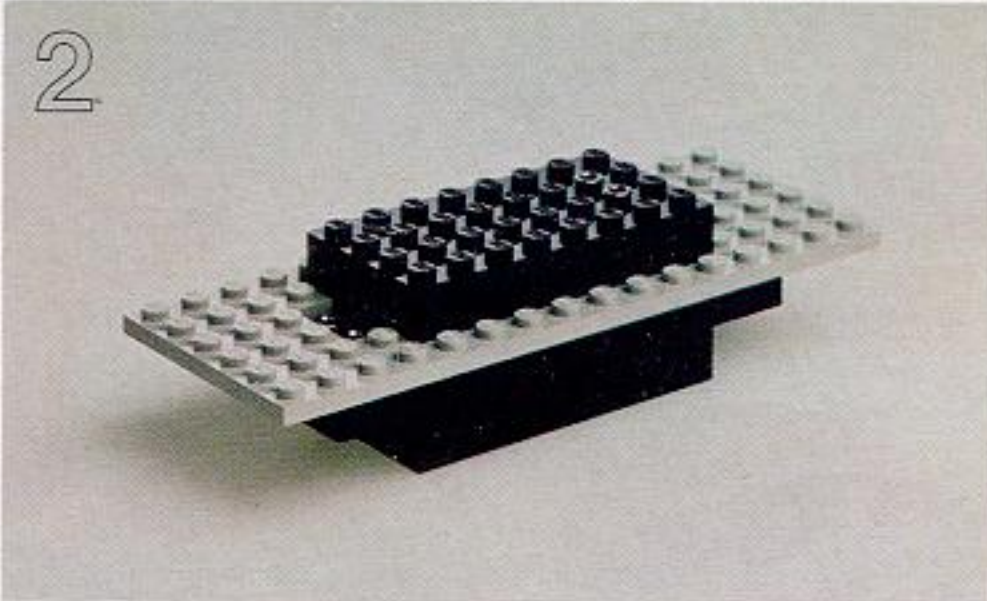
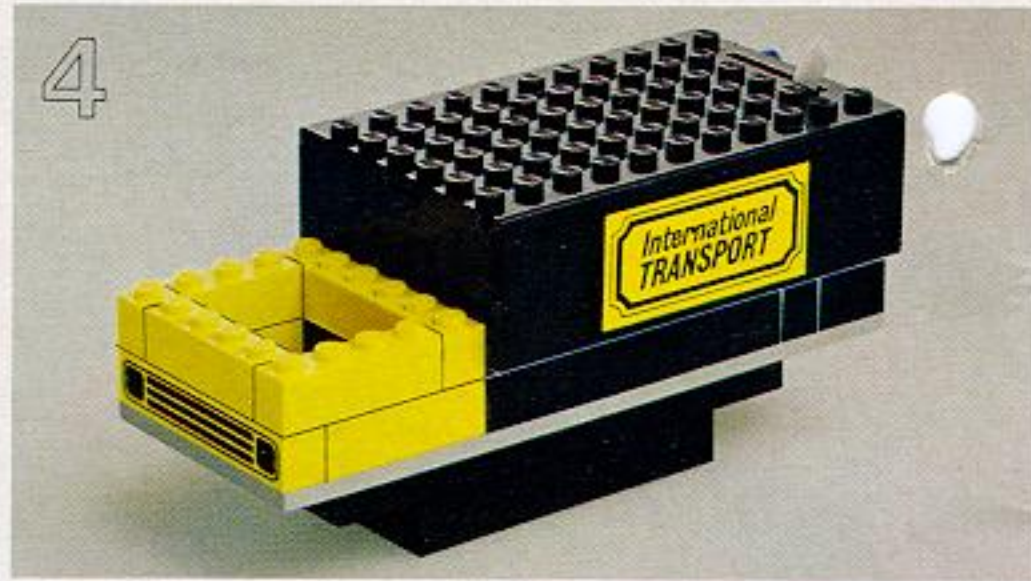
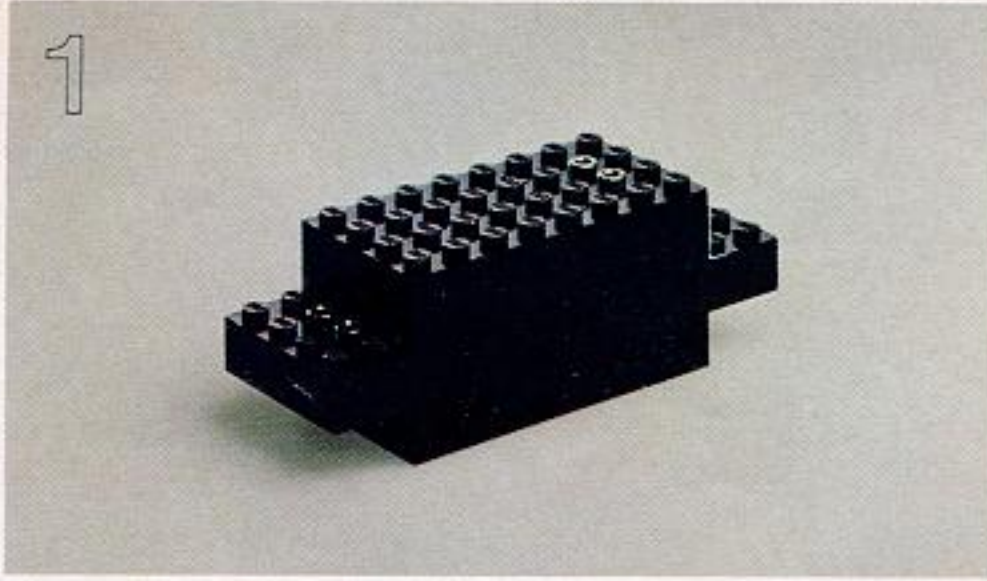

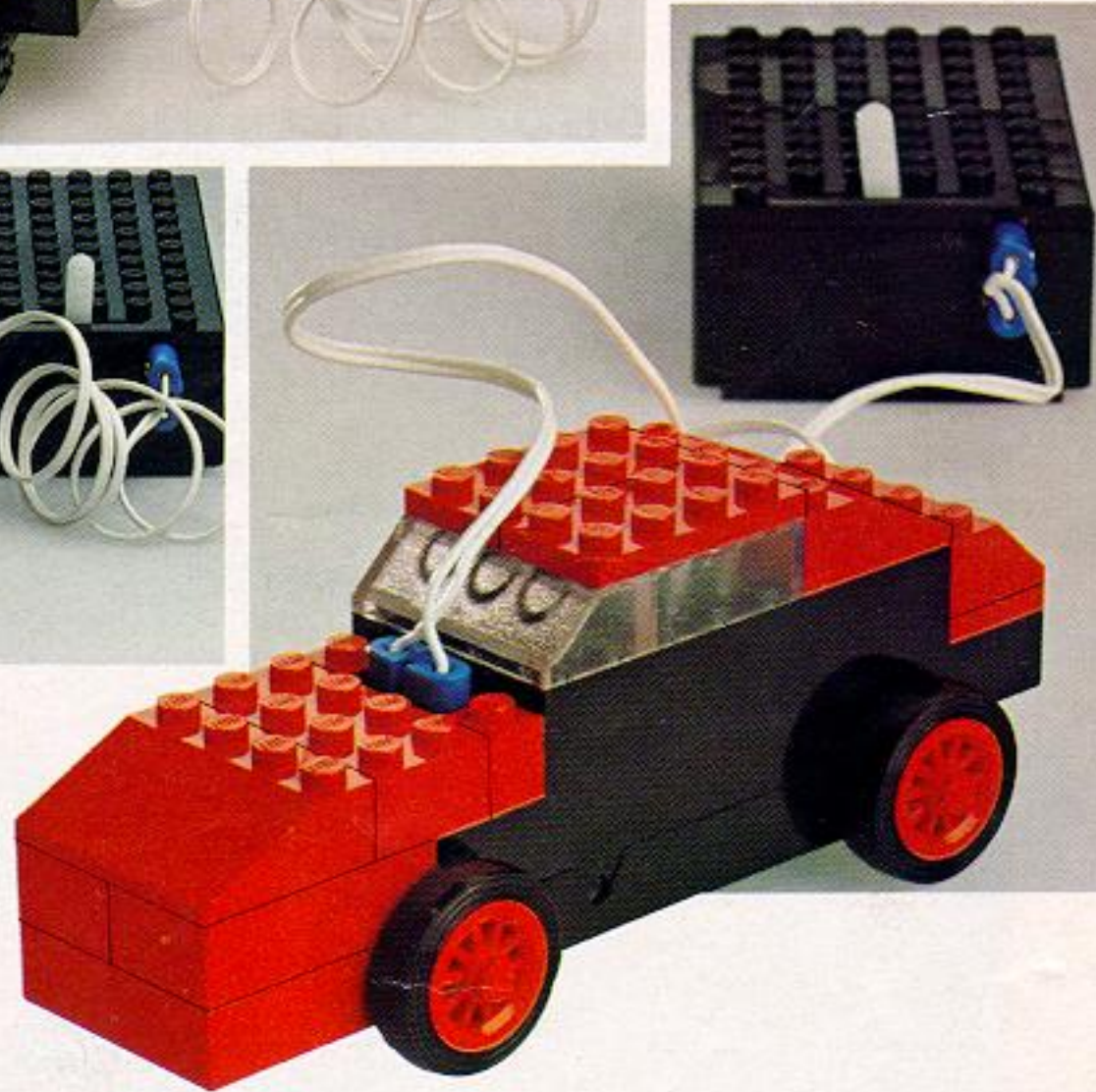
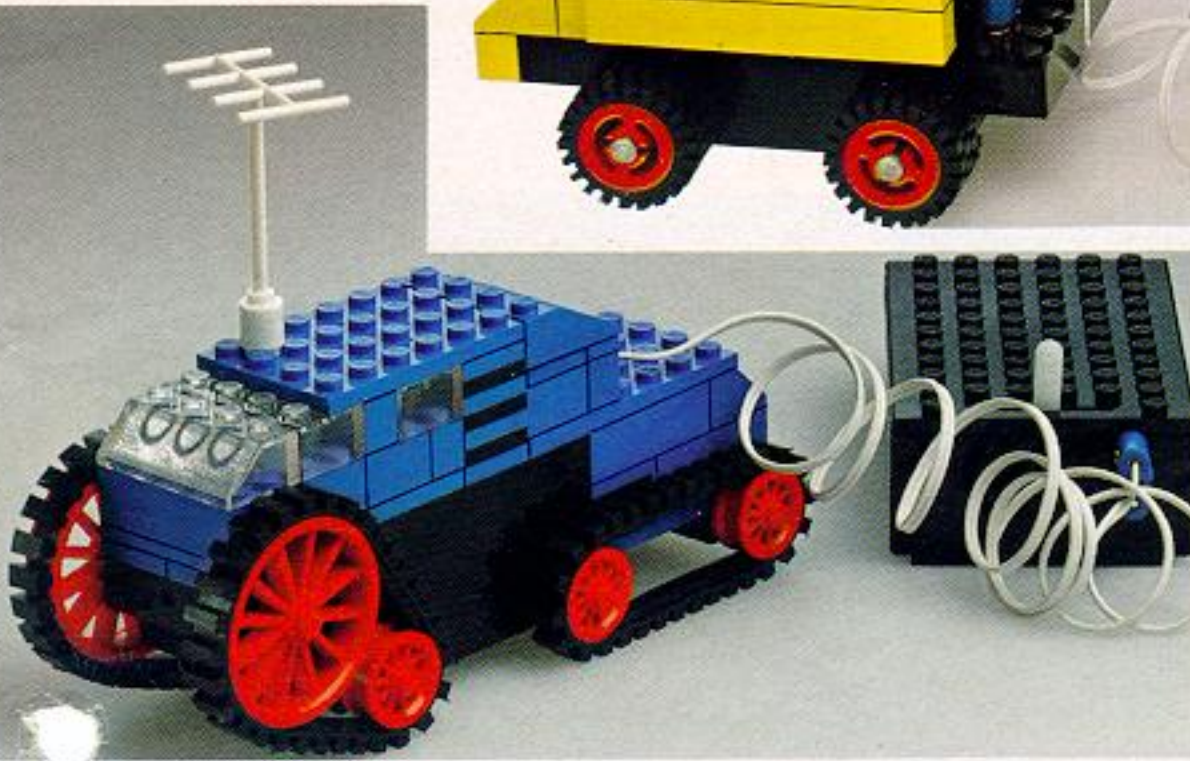
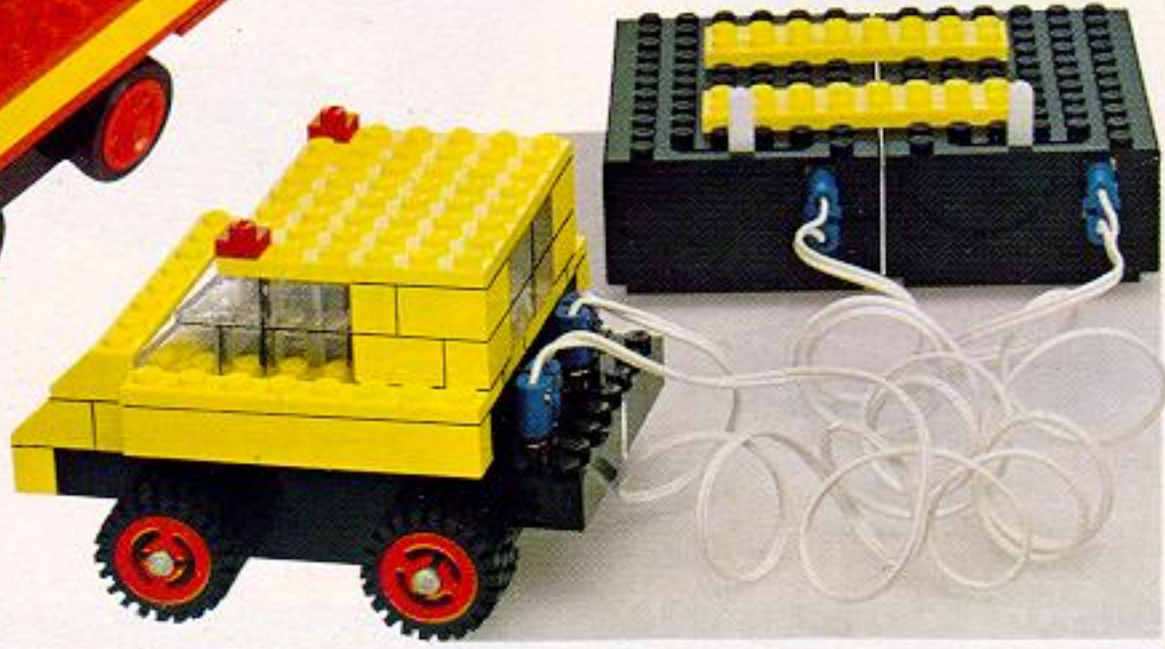

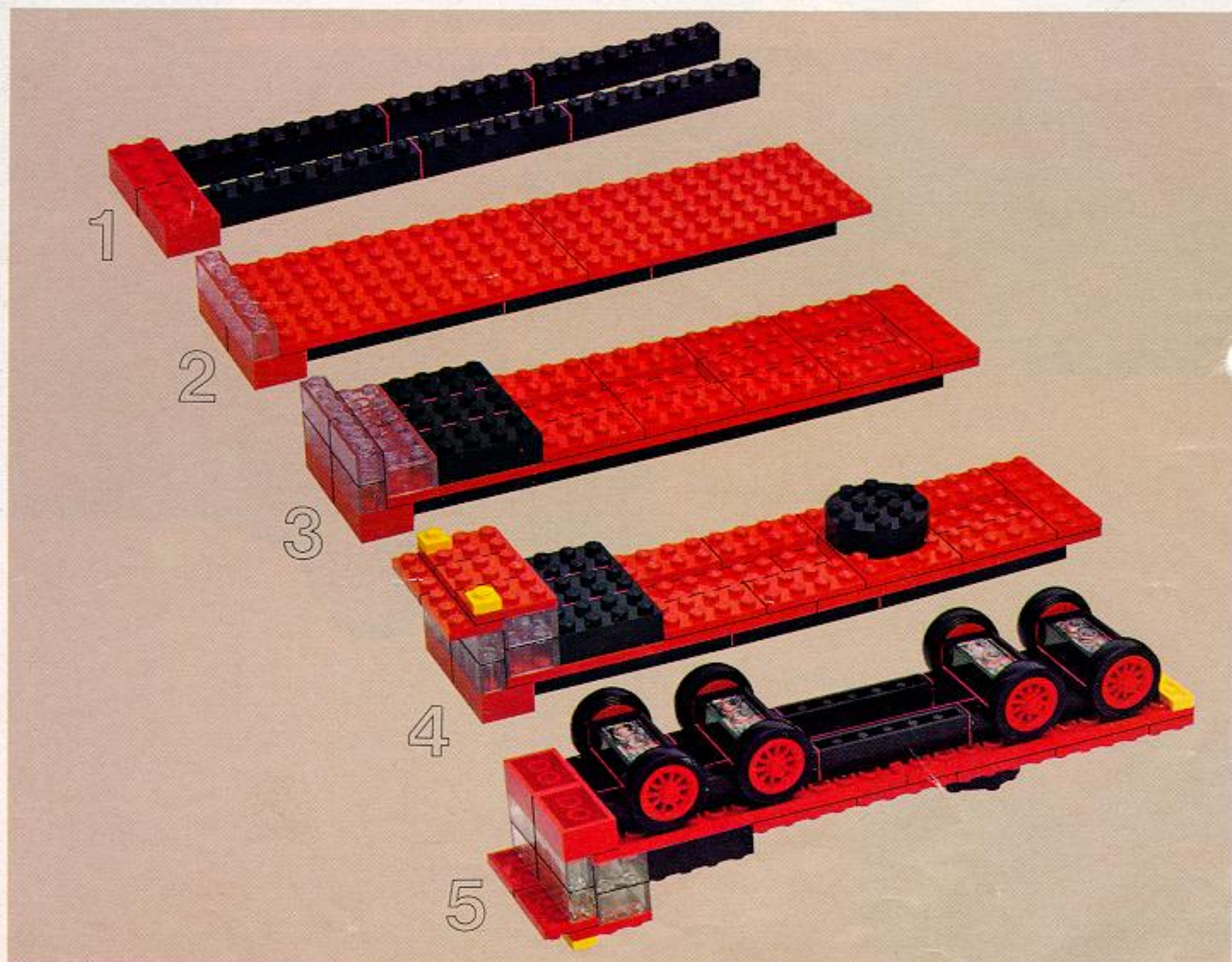
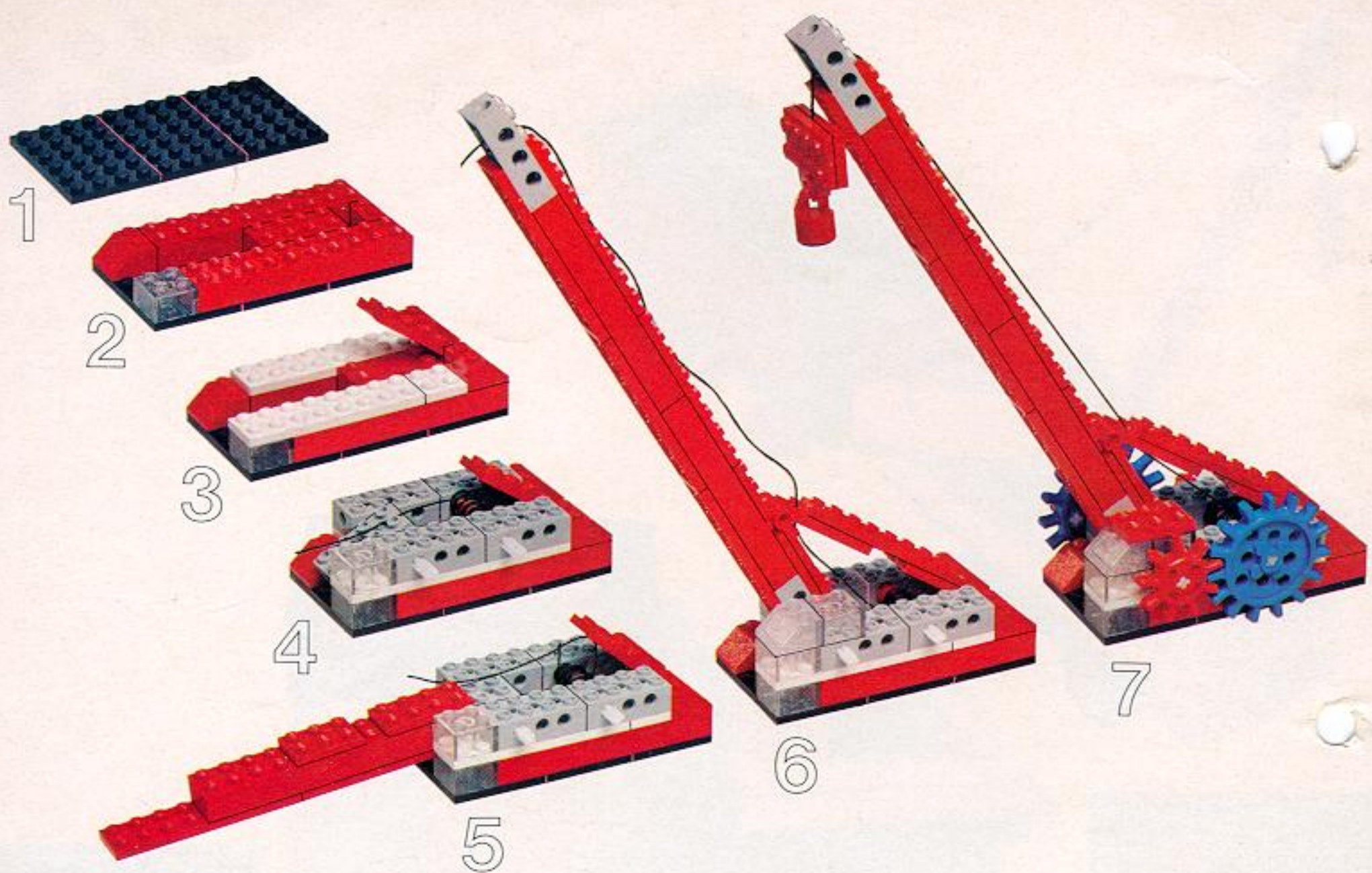

75

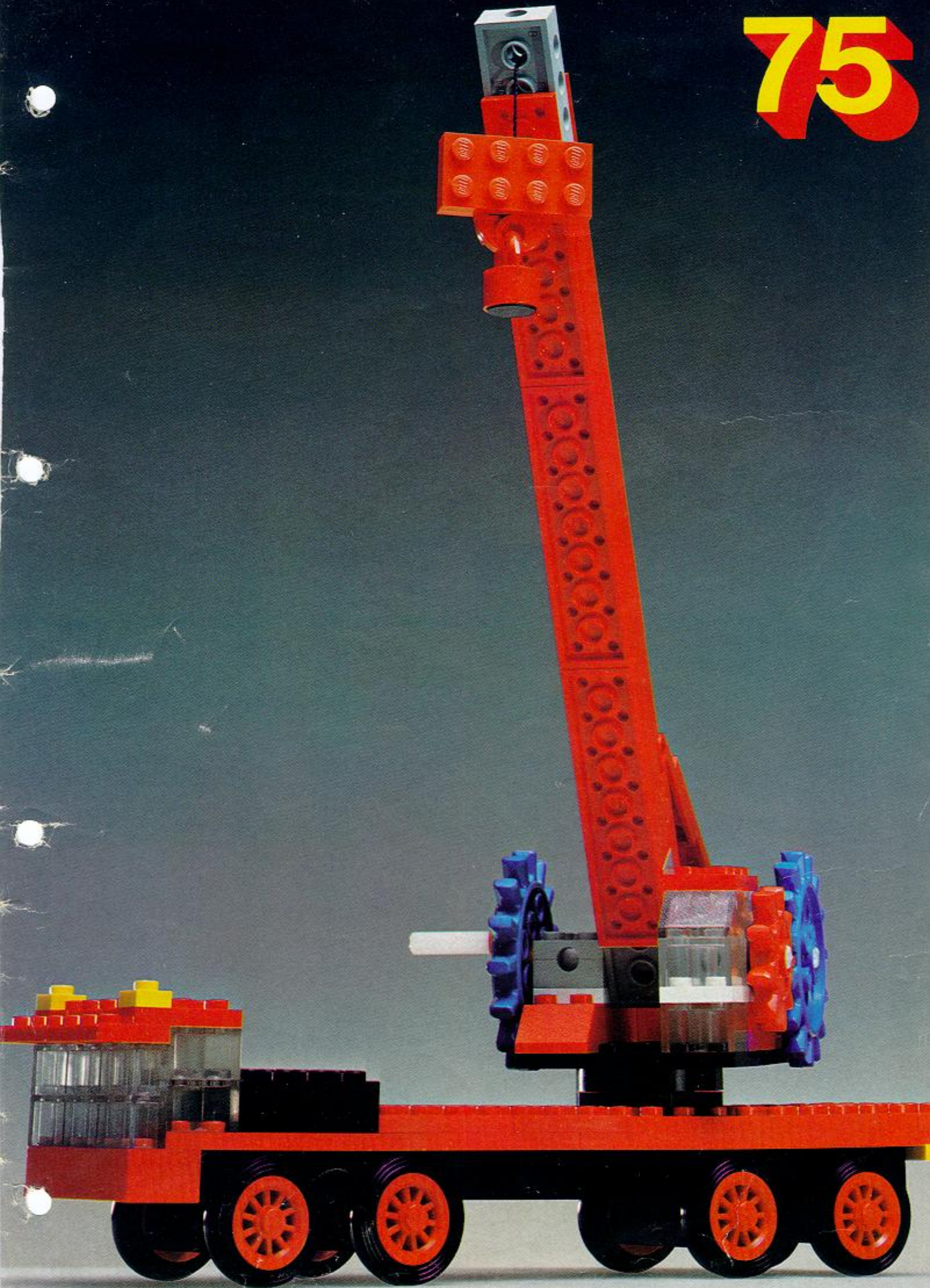

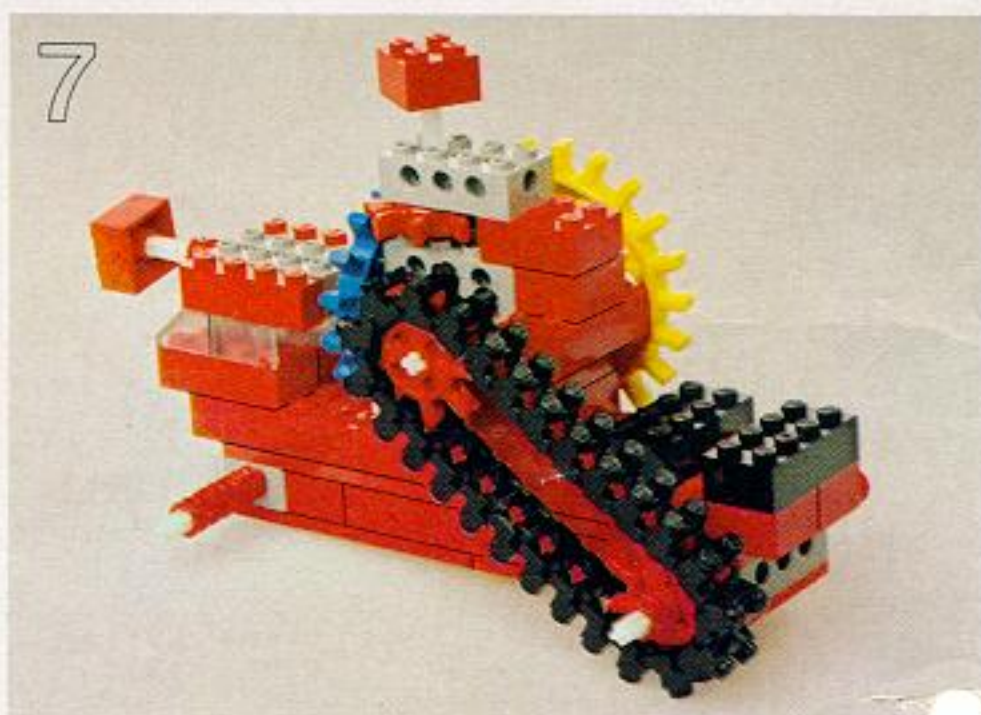
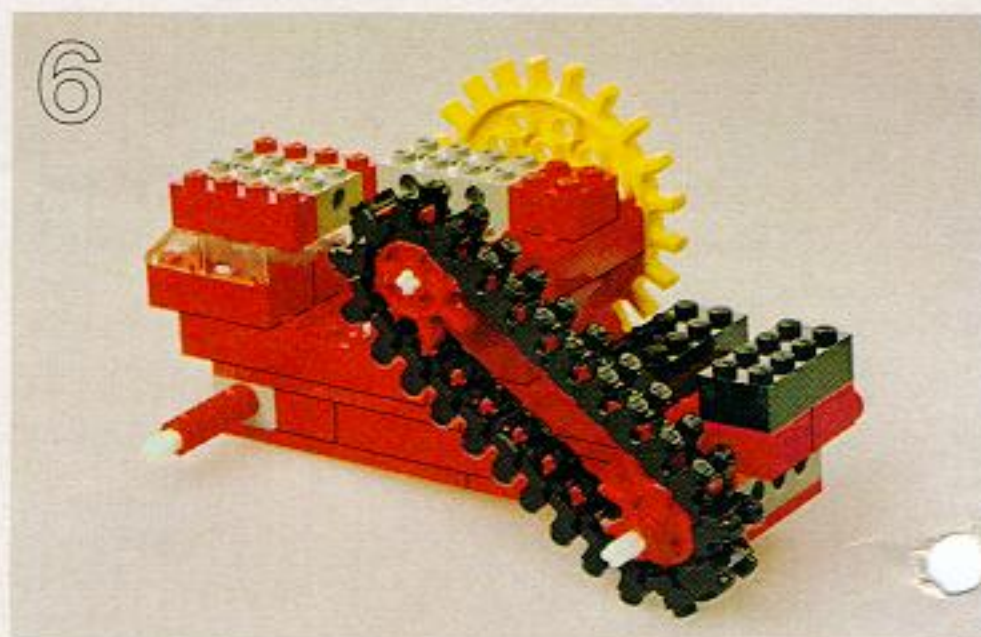
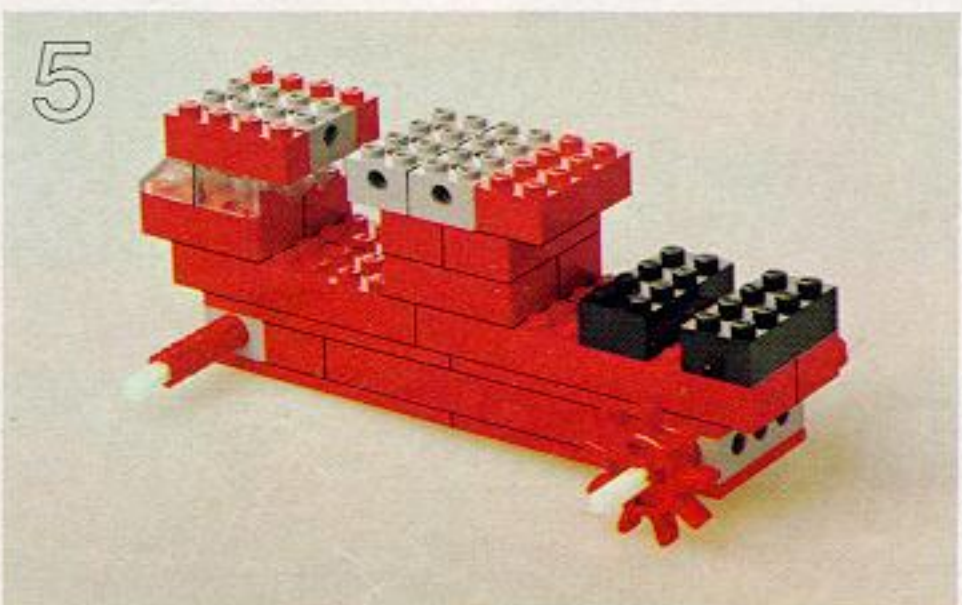
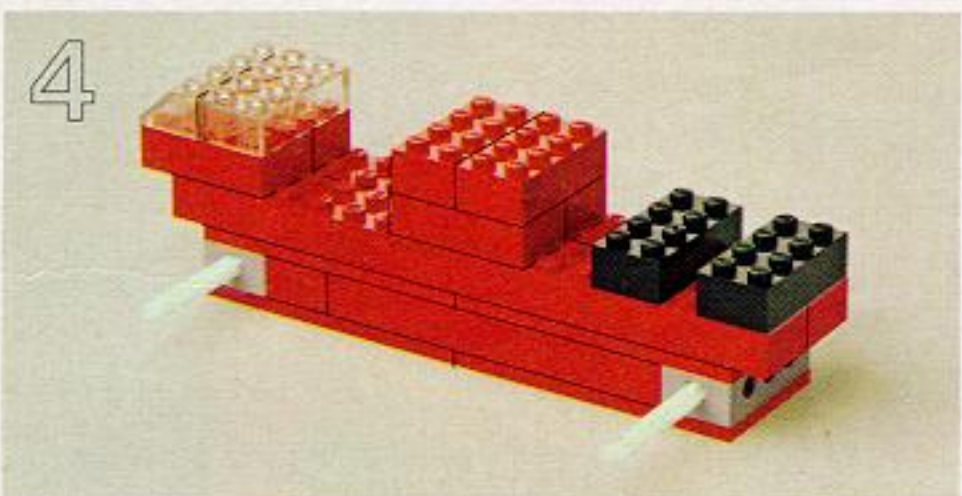
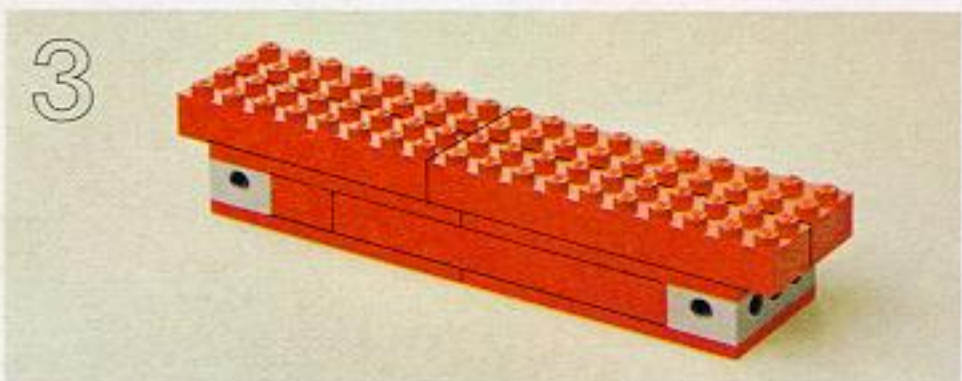
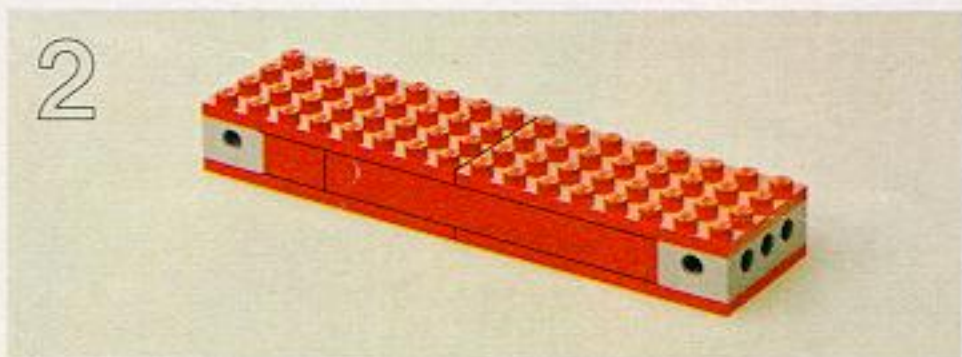
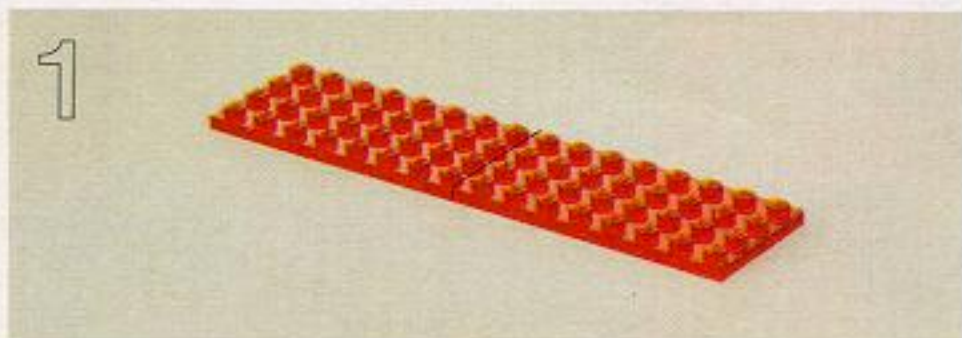

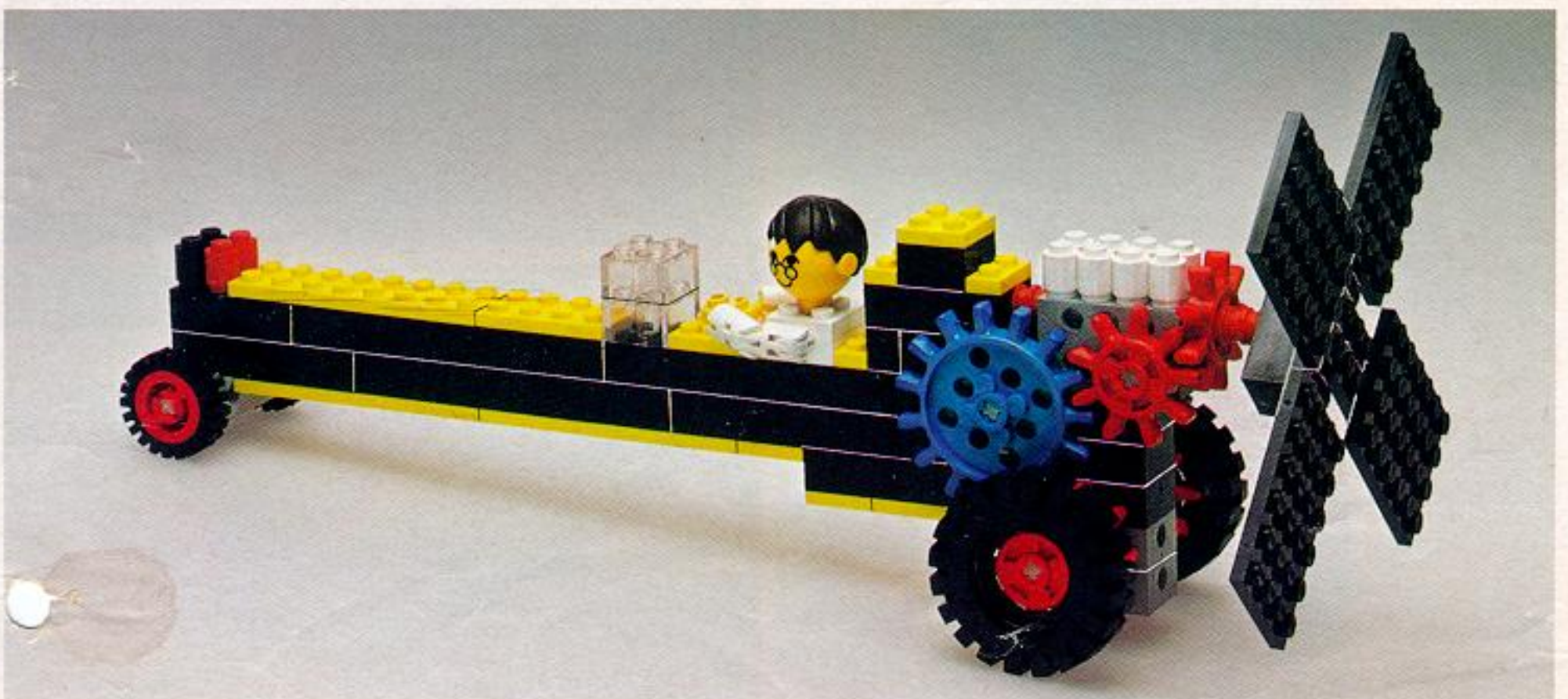
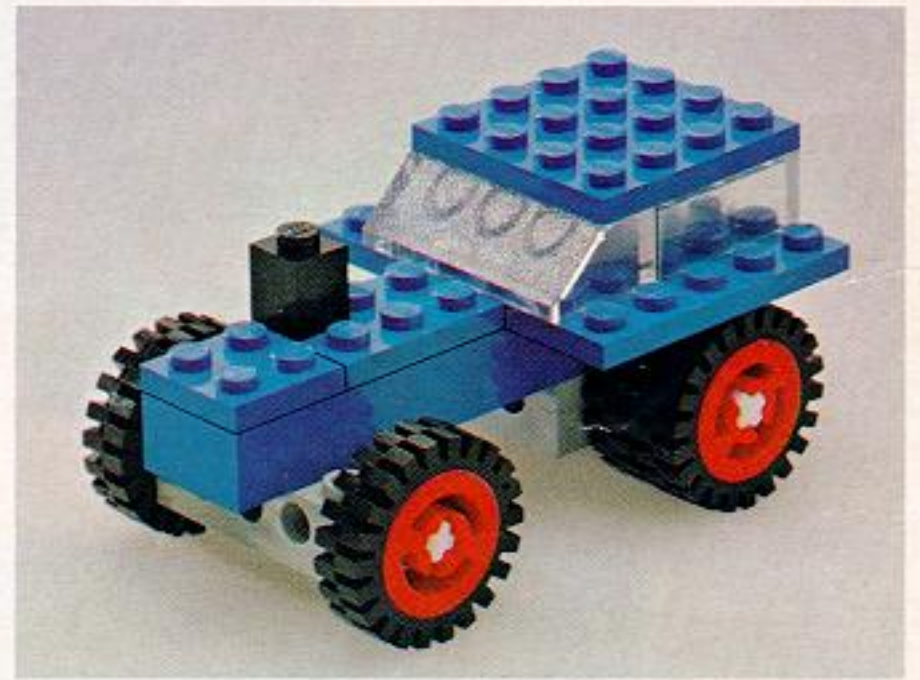
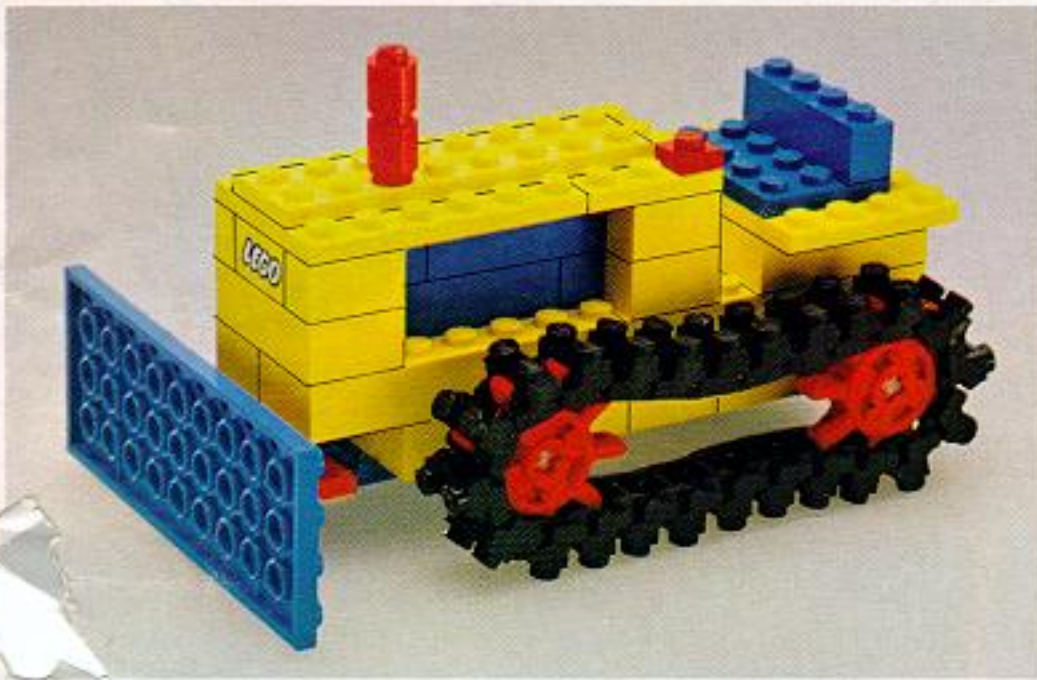
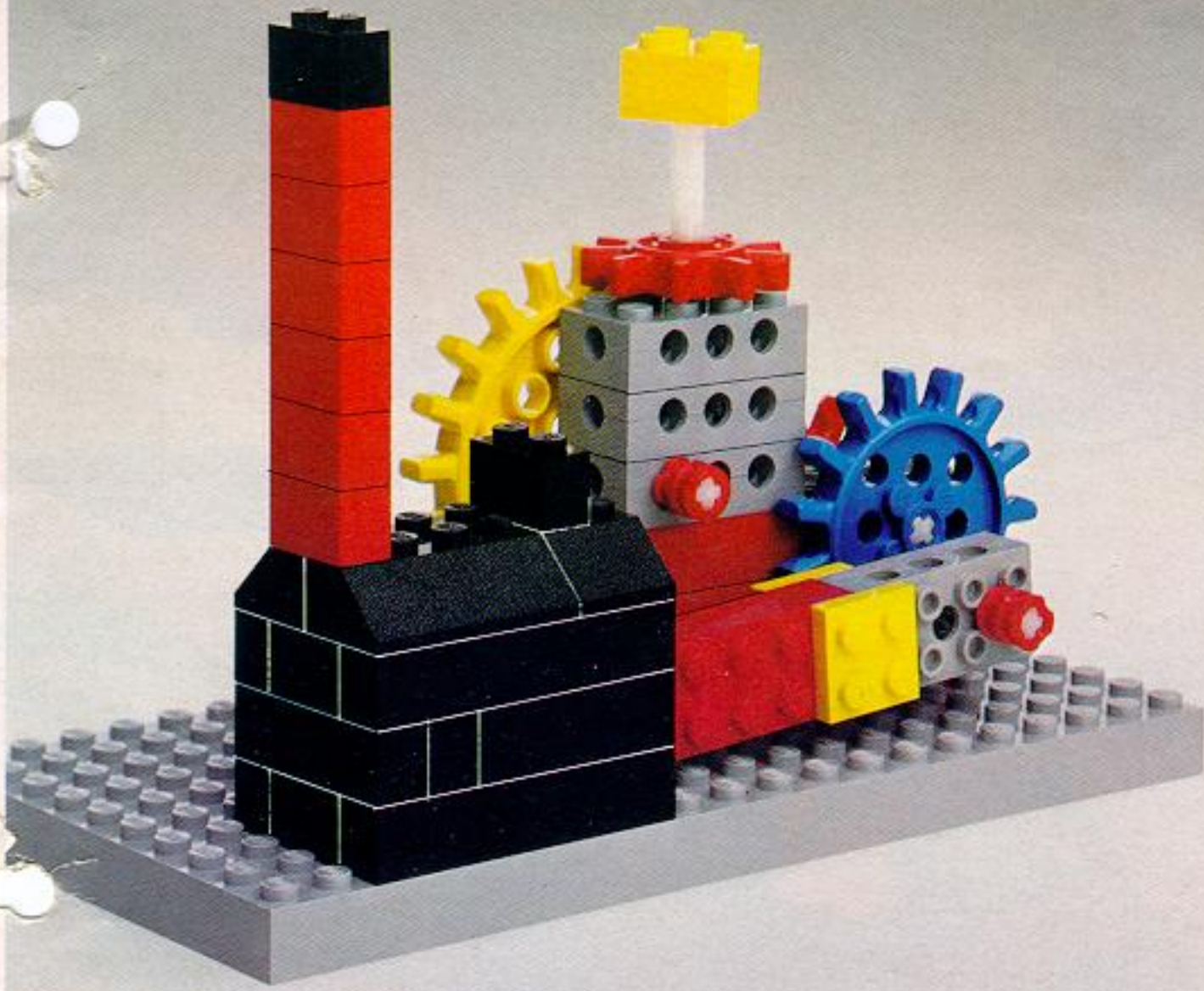

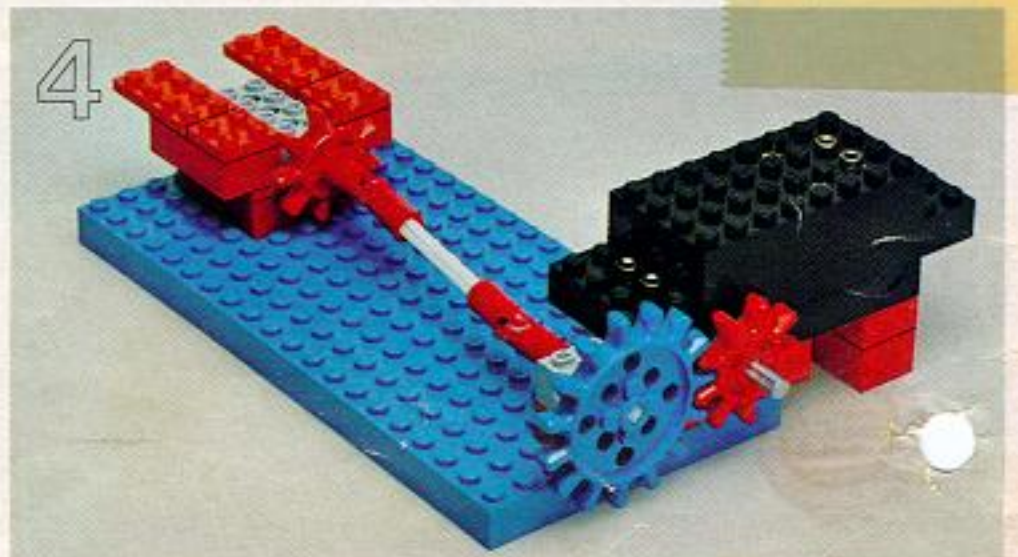
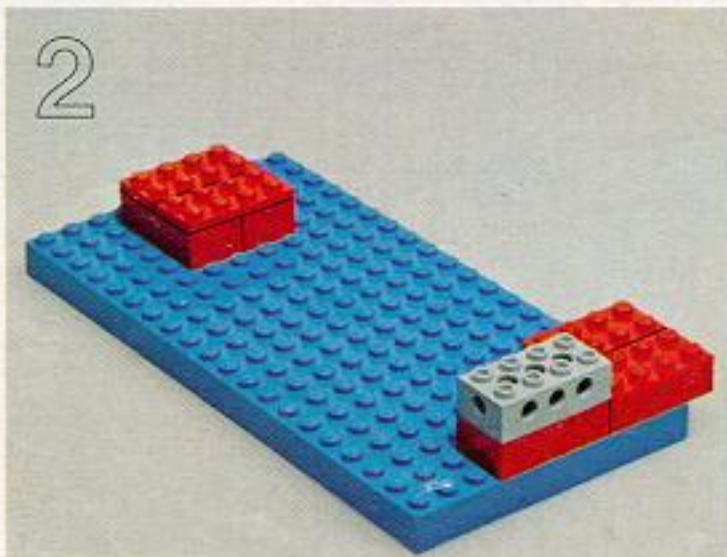
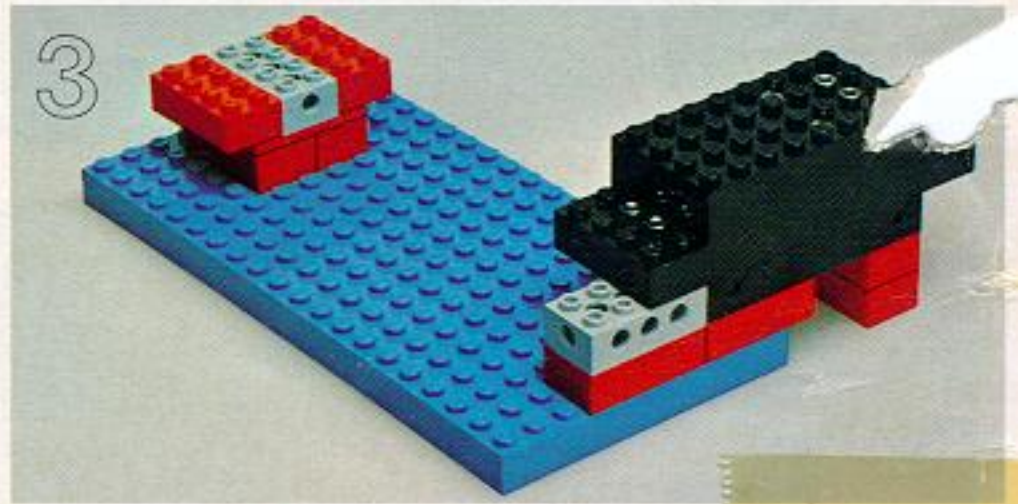
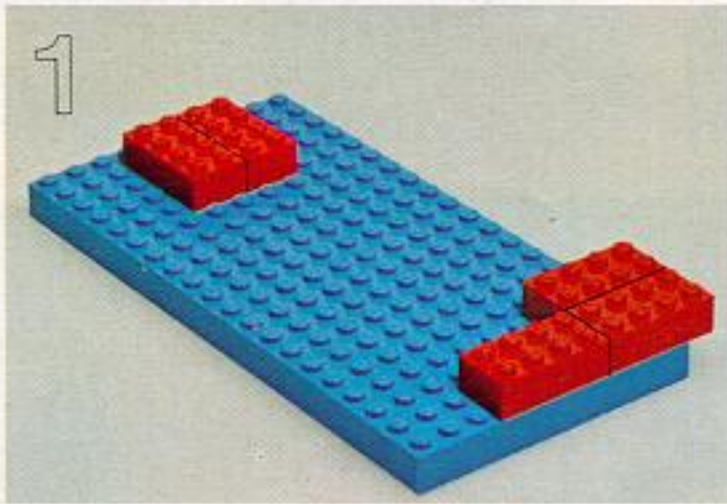

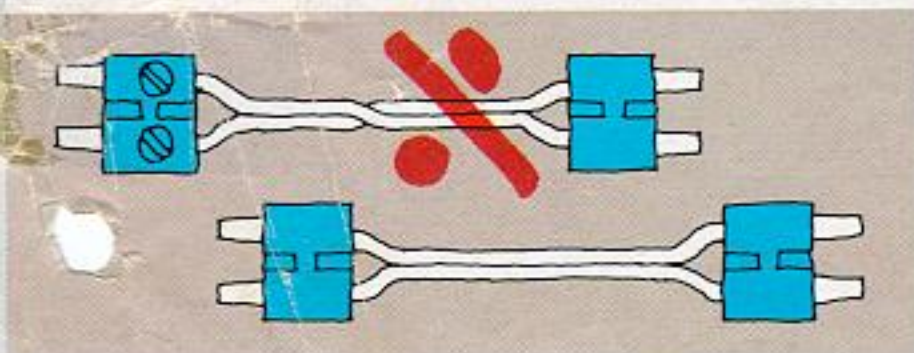
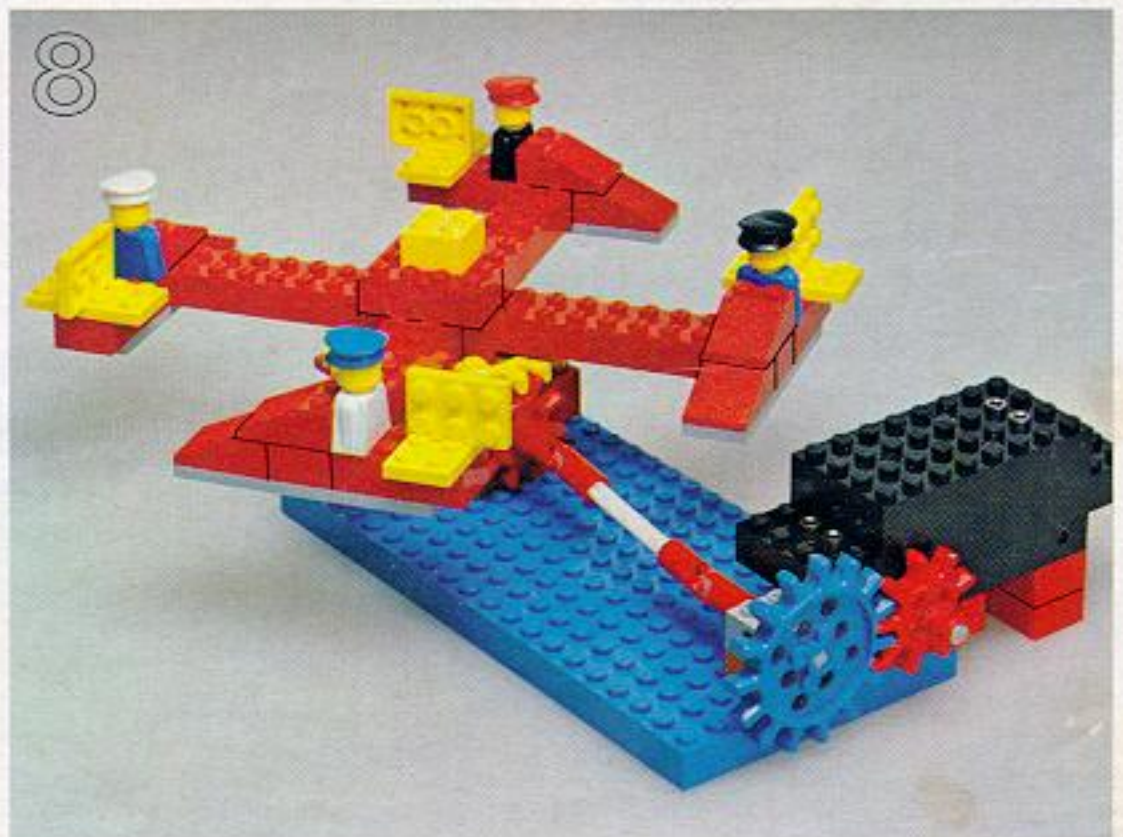
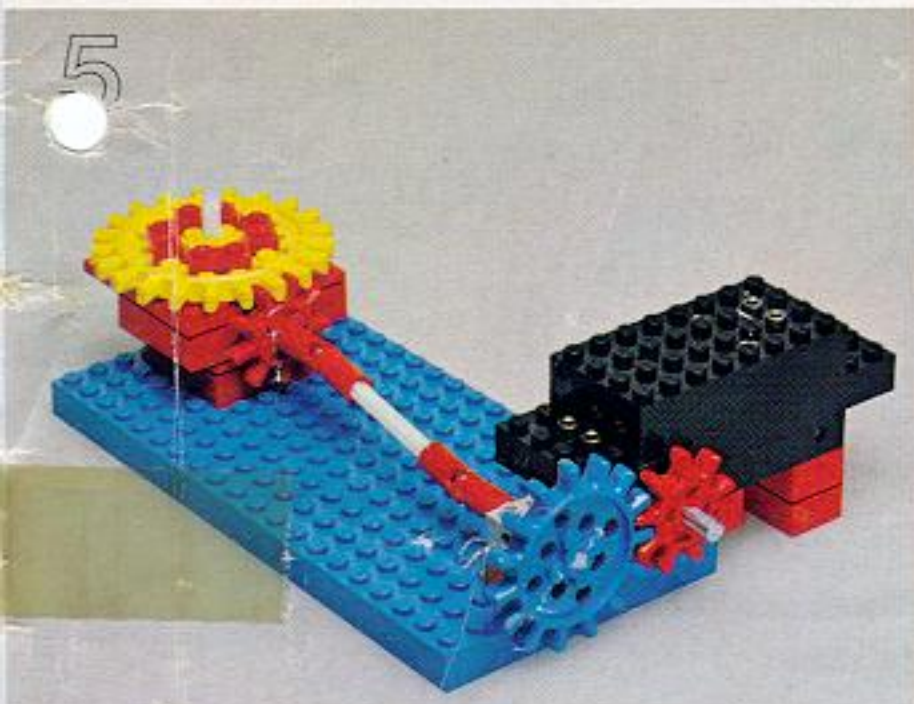
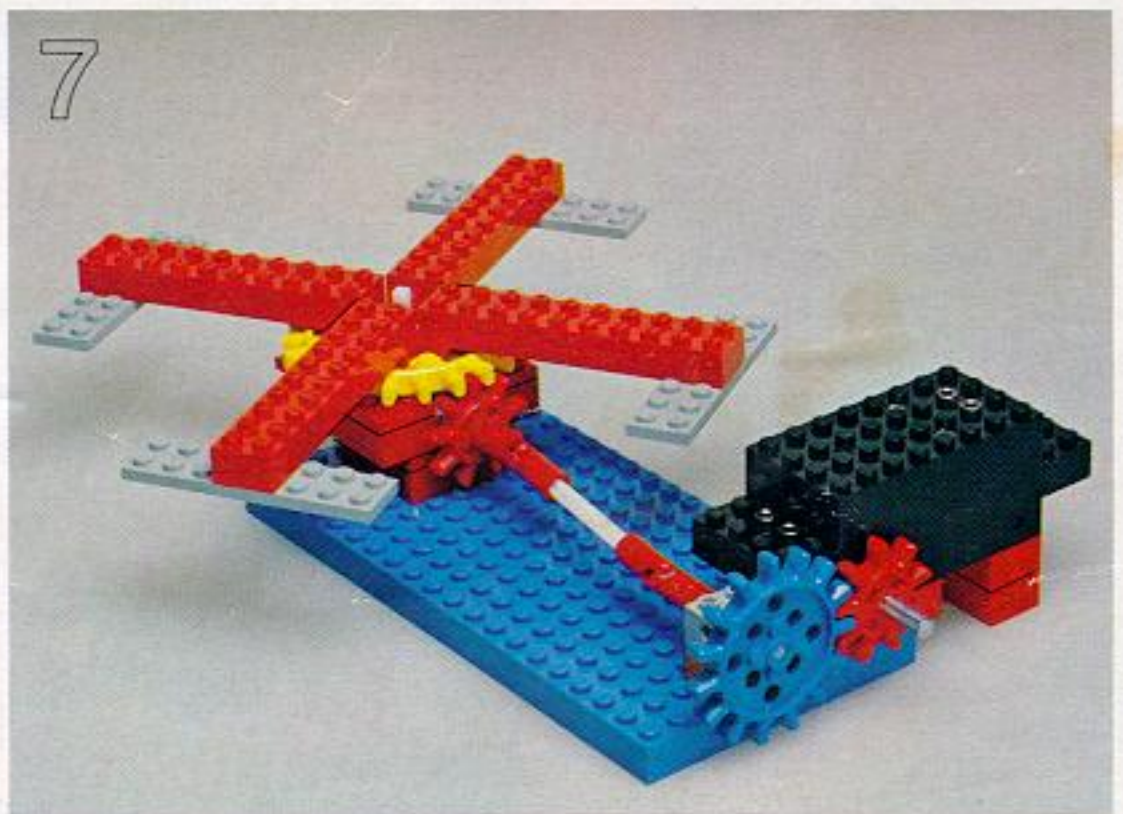
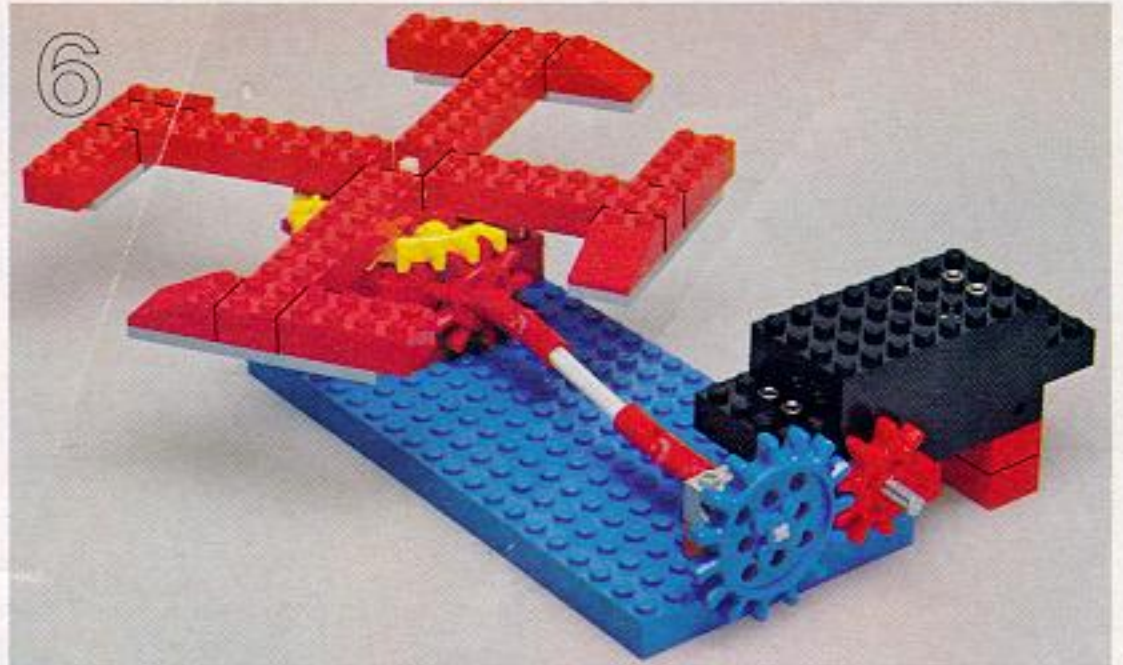
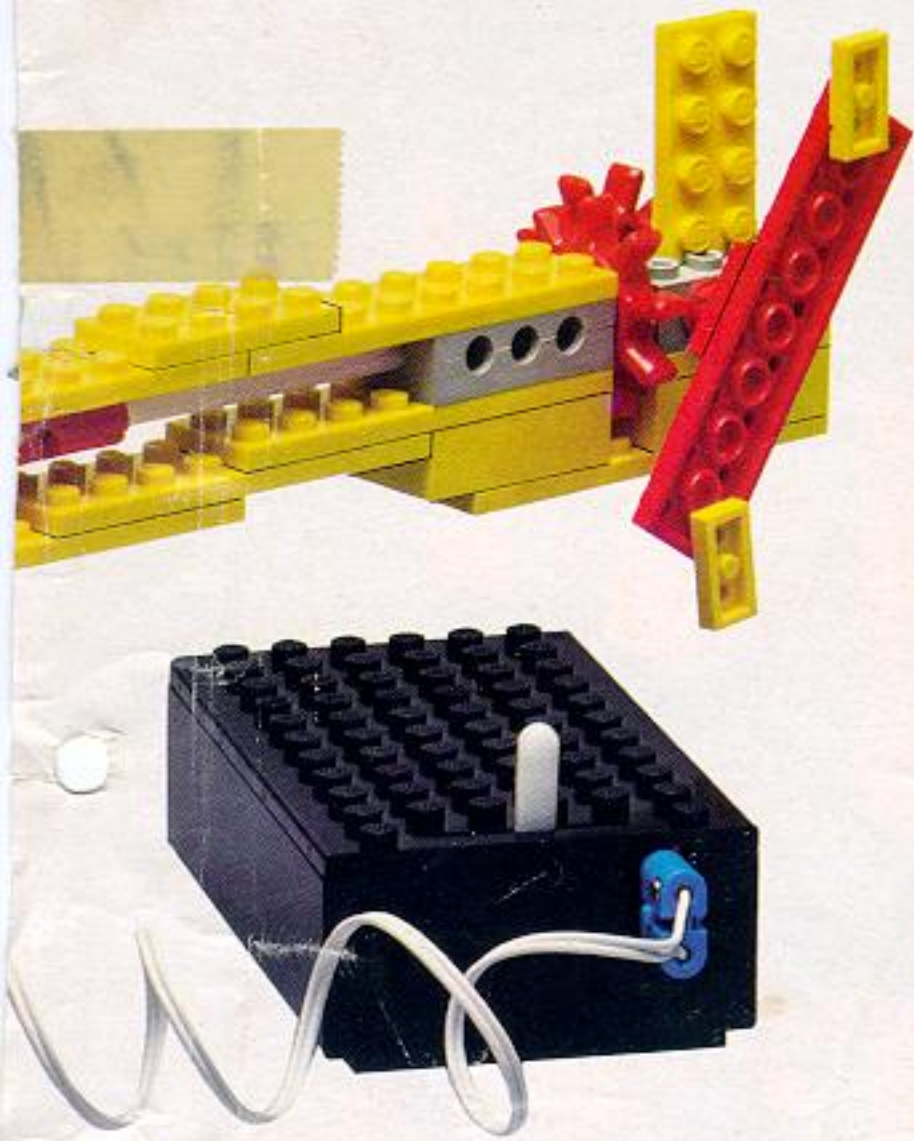

80



