

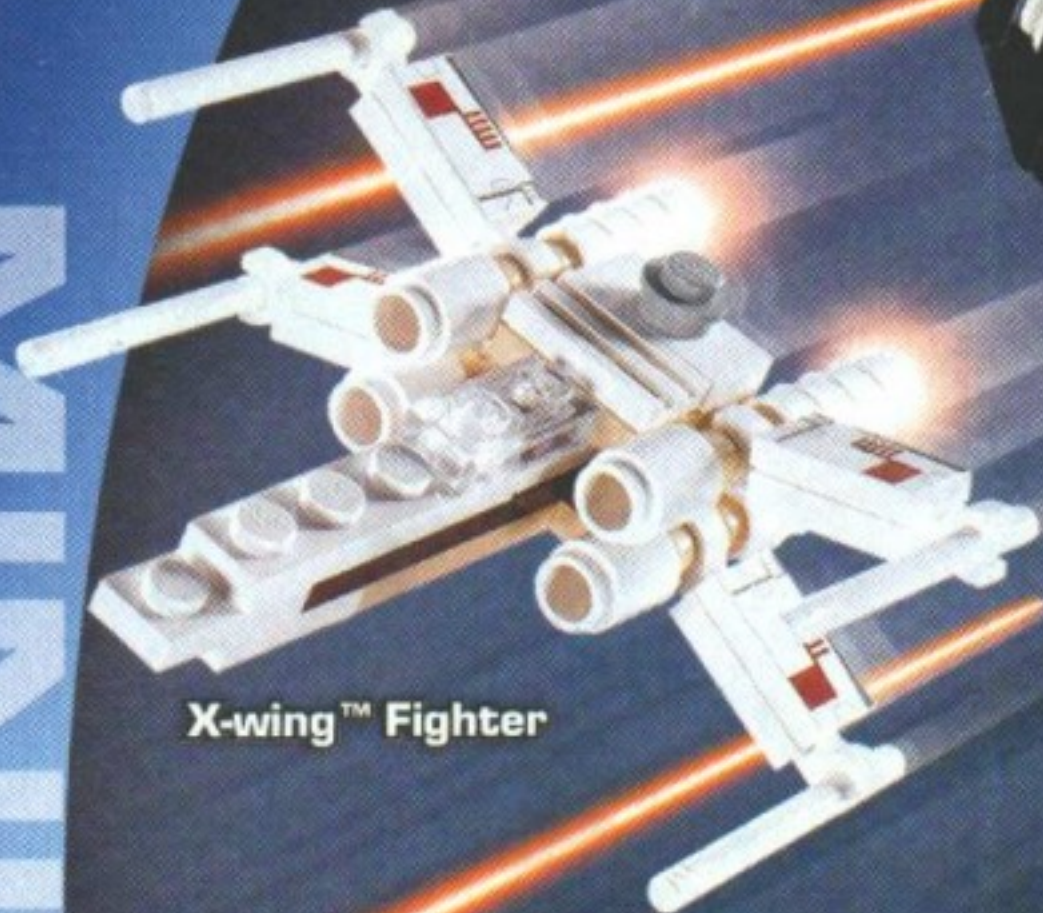

STAR WARS

4484

MINI BUILDING SET



X-wing™ Fighter

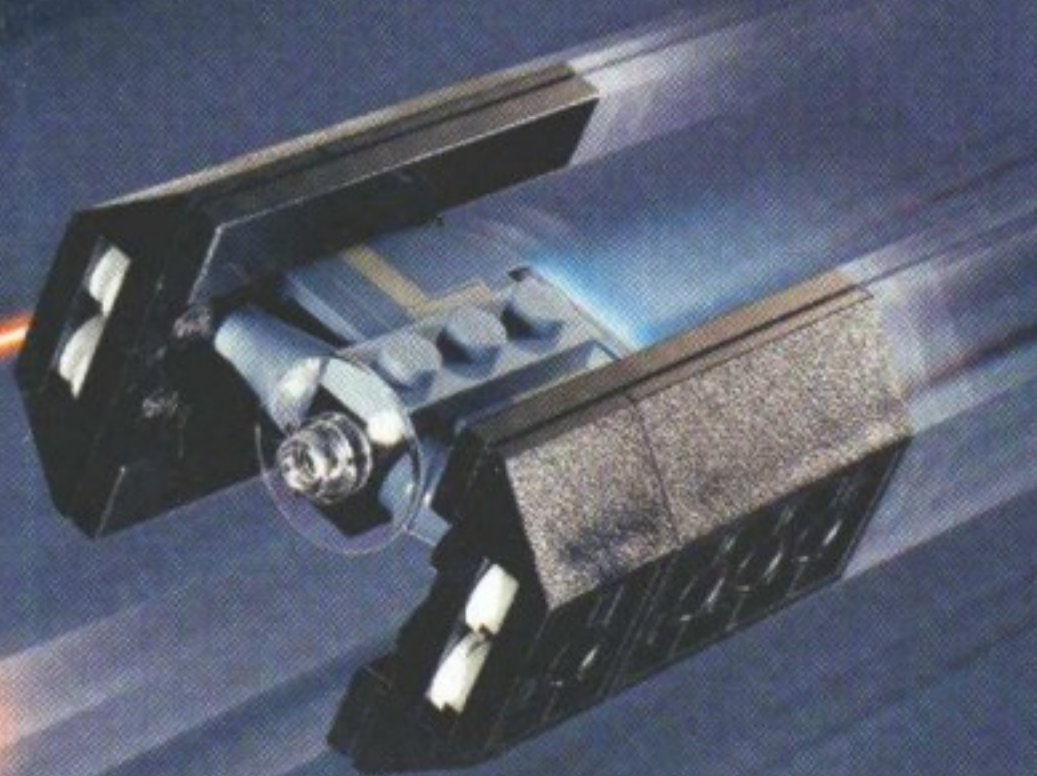

TIE Advanced™

MINI

4193294

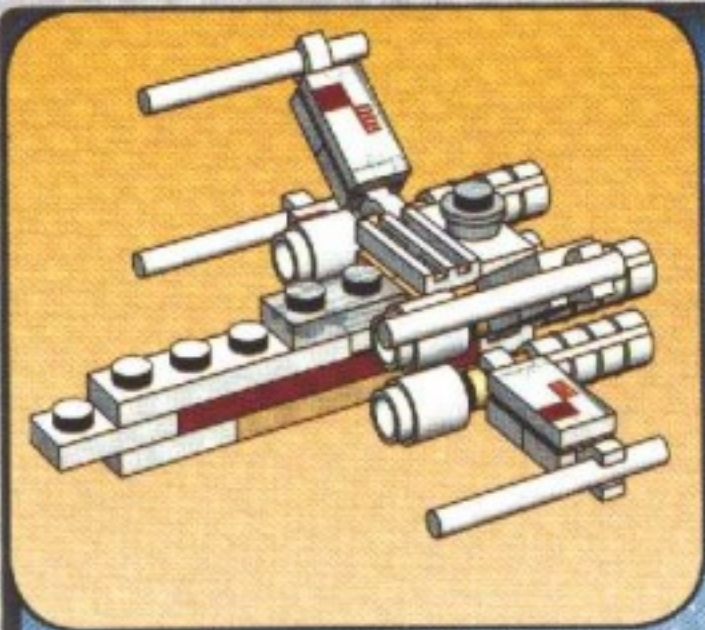

1



2

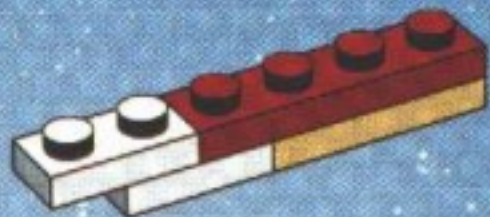

3

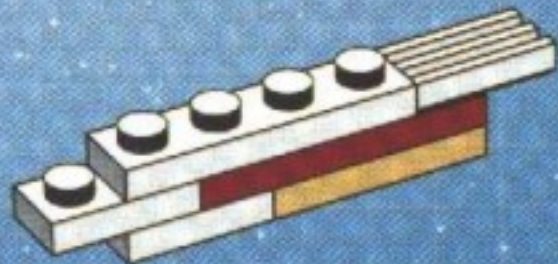

4

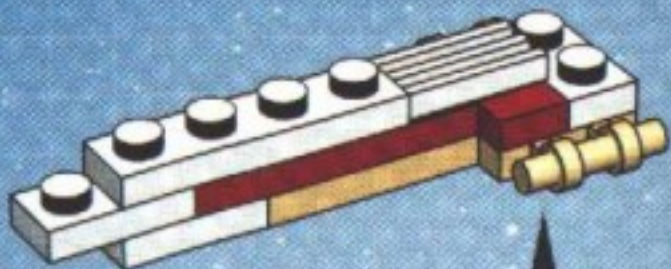

5

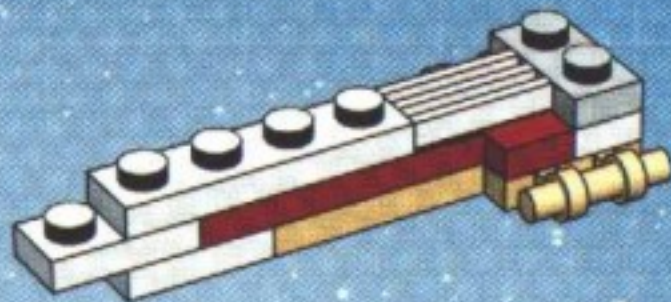

6

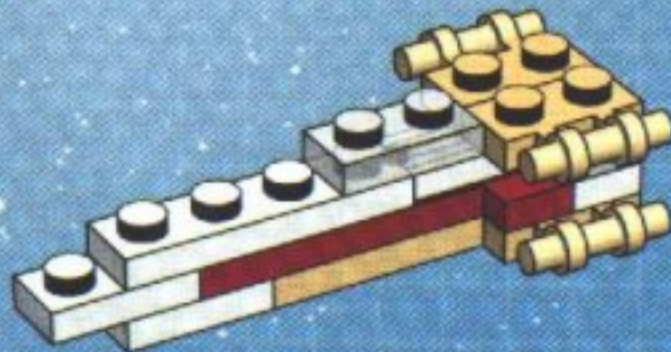

1



2



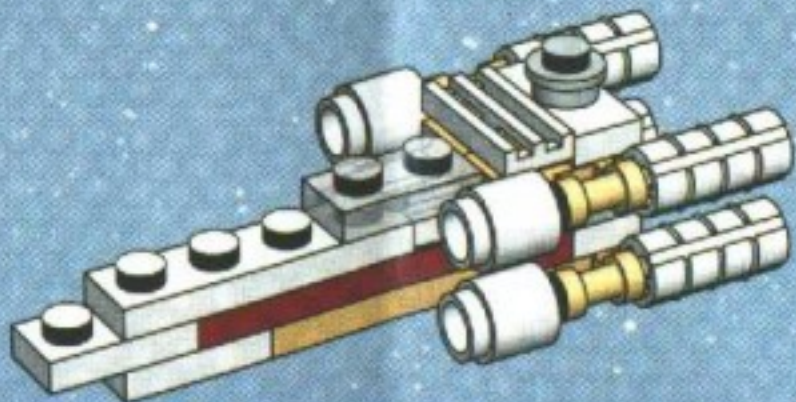

1

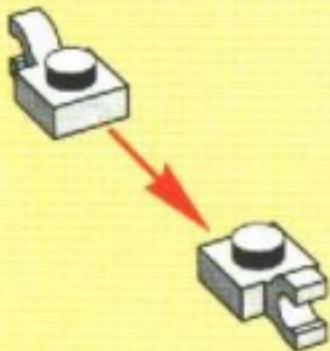

2



3

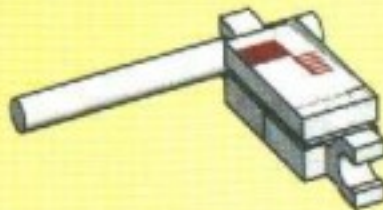

2x

9

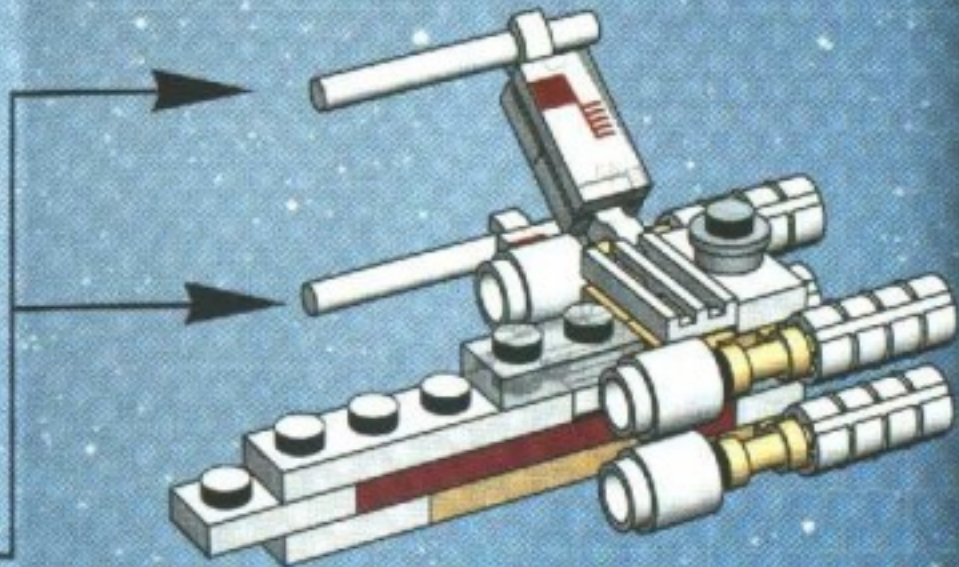

1

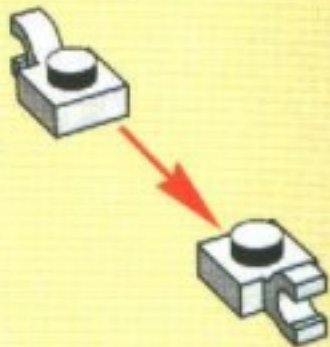

2



3

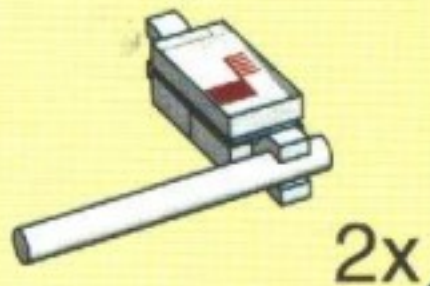

10

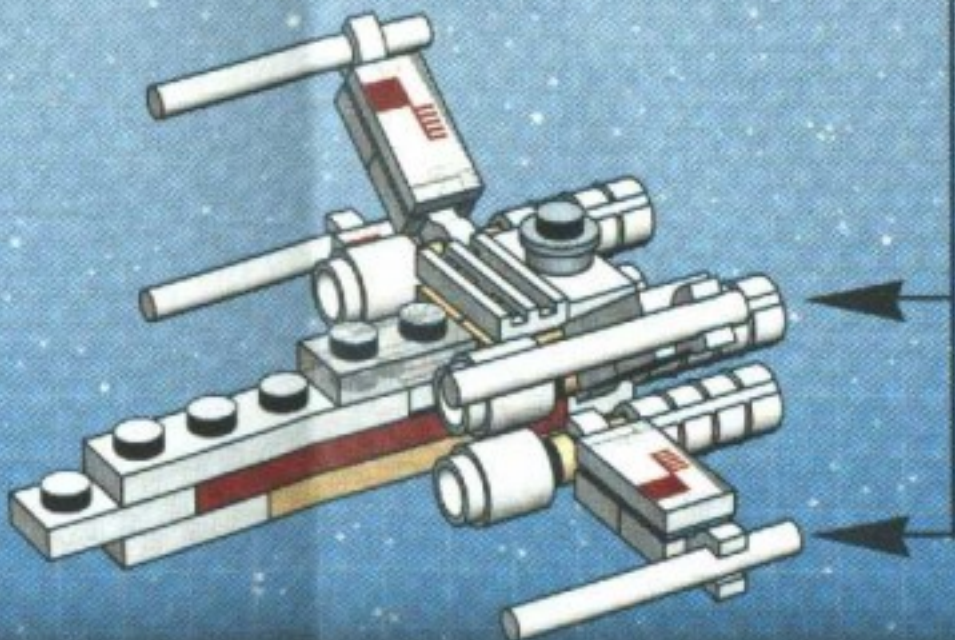

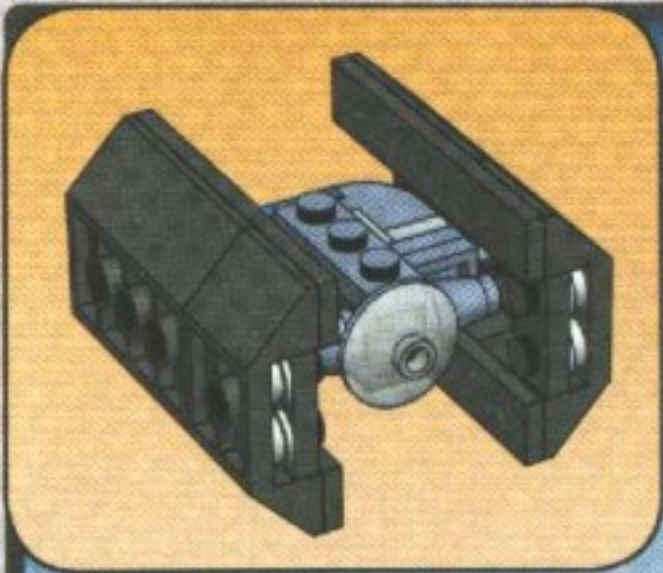

1

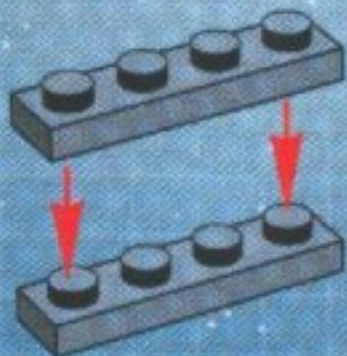

2

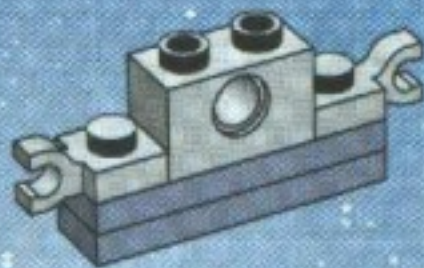

3

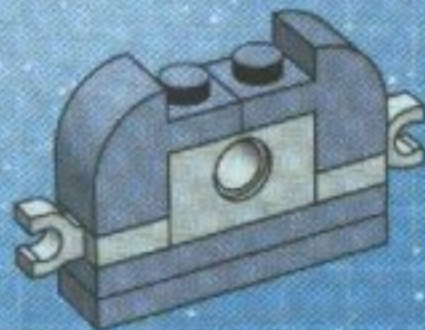

4

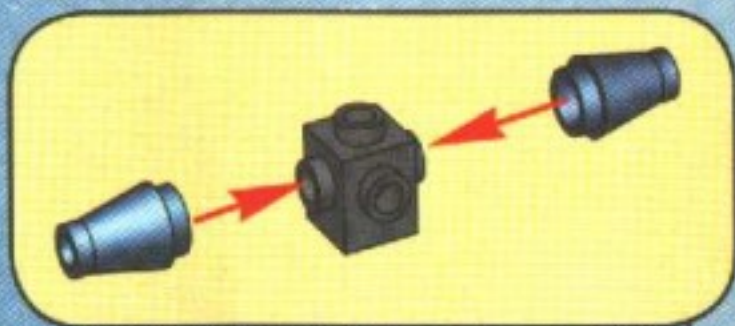
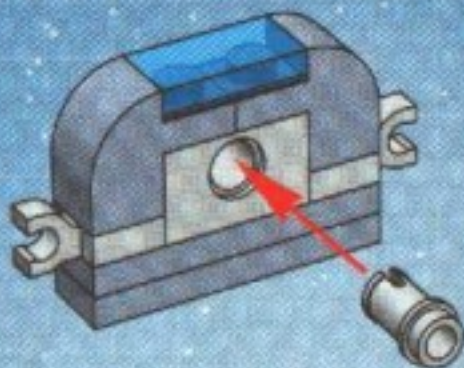

5



6



7



1



2



3

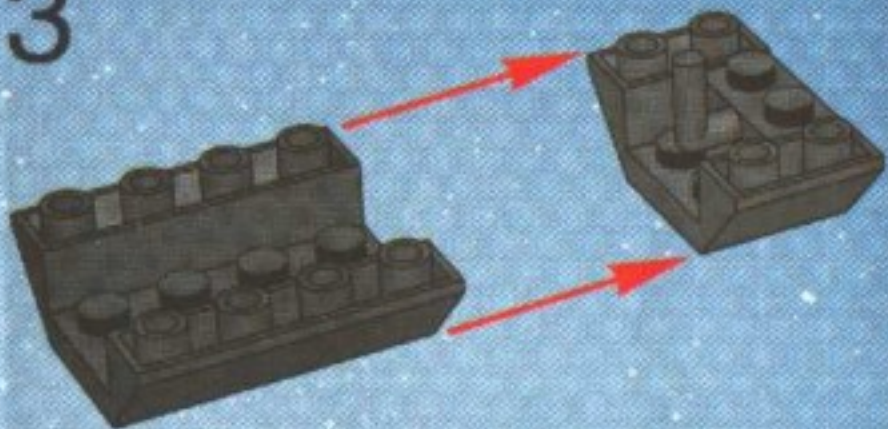

4

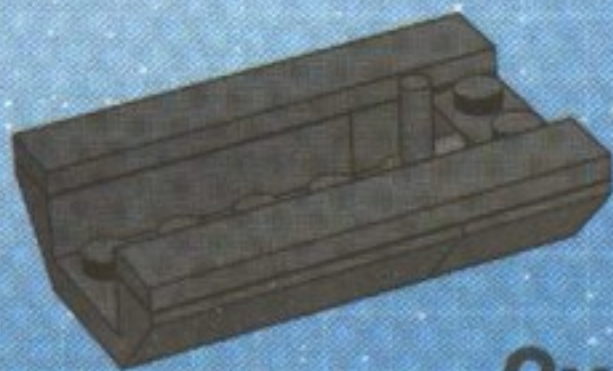

2x

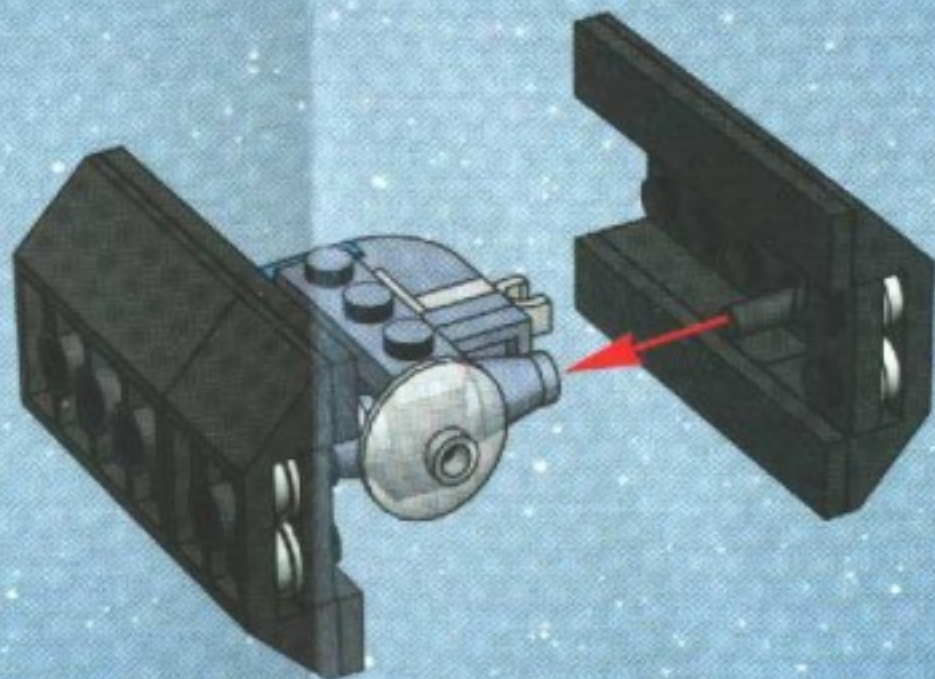



STAR WARS

WIN



4484



4486



4487



4485



1

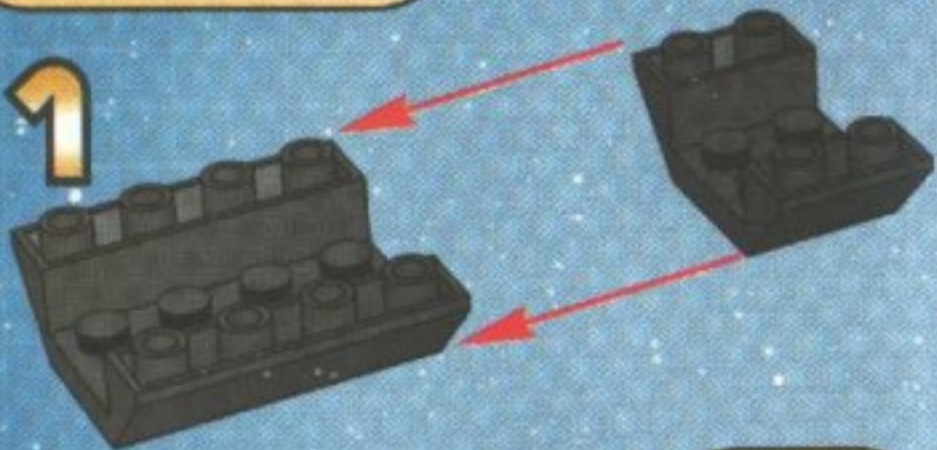

2

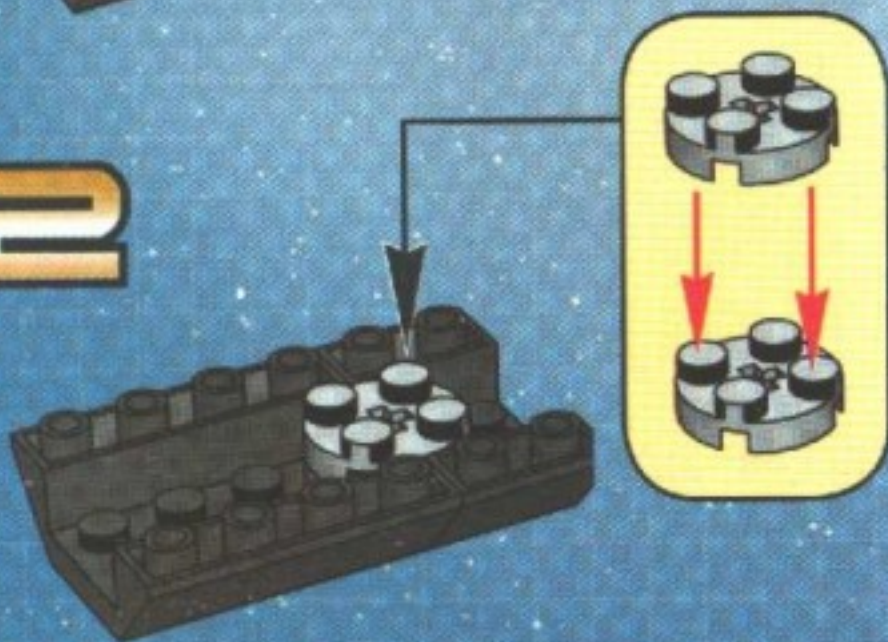

B

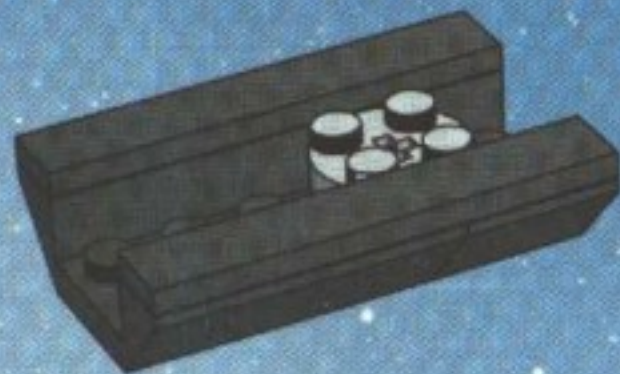

4

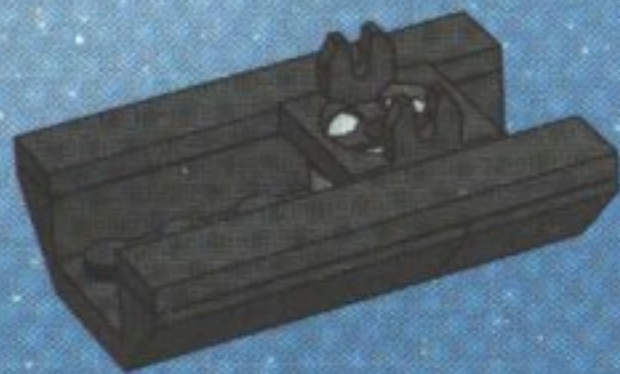



1

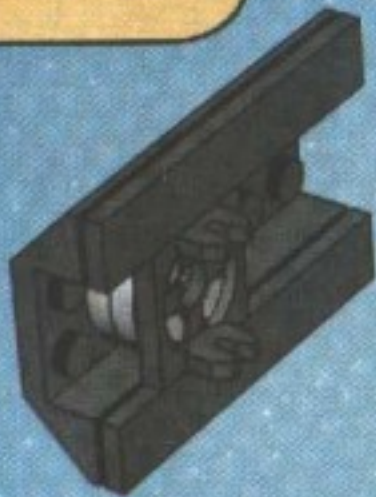

2



3

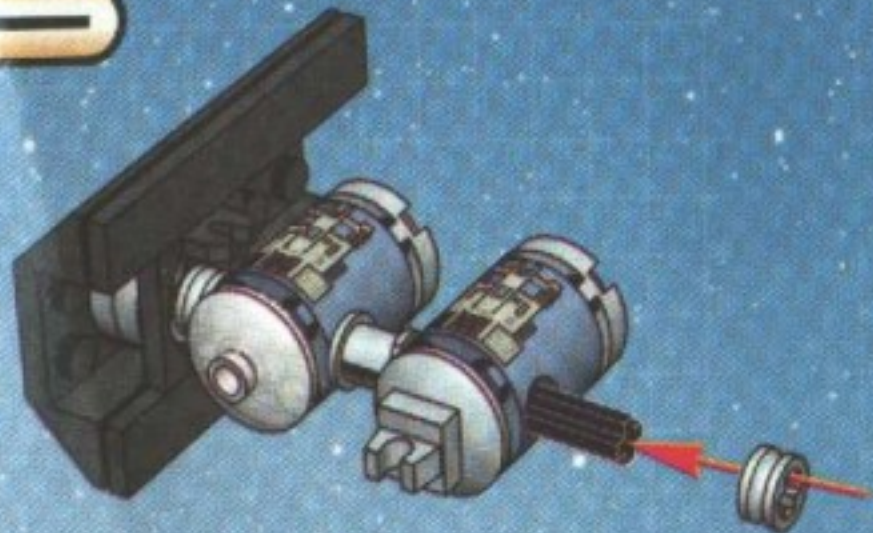

4

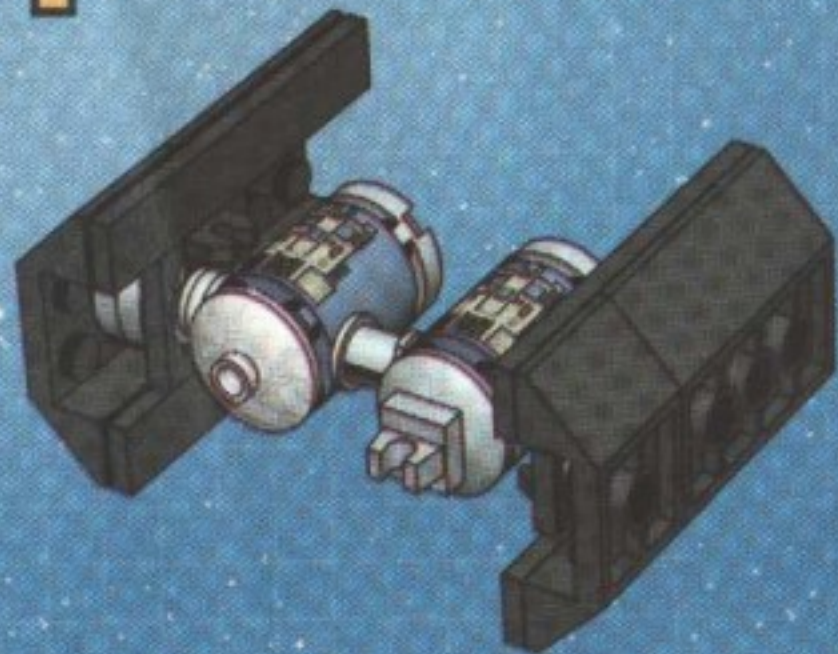

STAR WARS
WWW.STARWARS.COM



www.LEGO.com



LEGO, the LEGO logo and the minifigure are trademarks of the LEGO Group.
© 2003 The LEGO Group.

© 2003 Lucasfilm Ltd. & TM. All rights reserved. Used under authorization

