

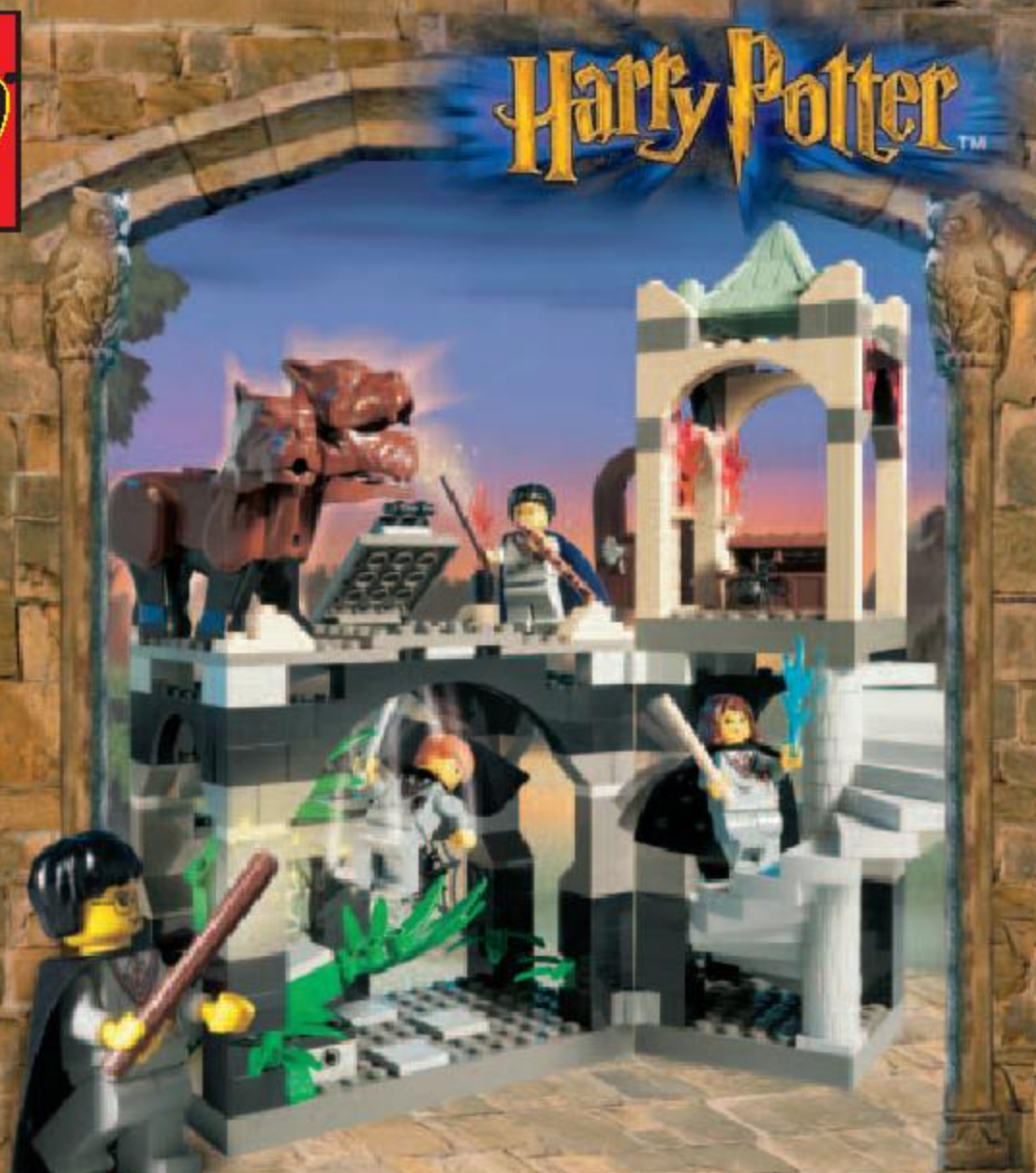

Harry Potter™



4706



1



2

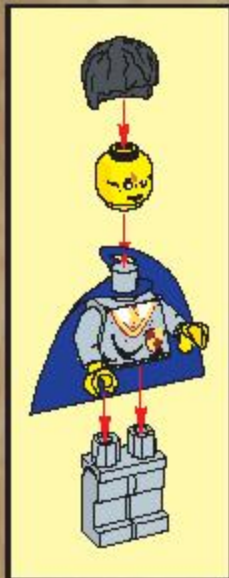

1

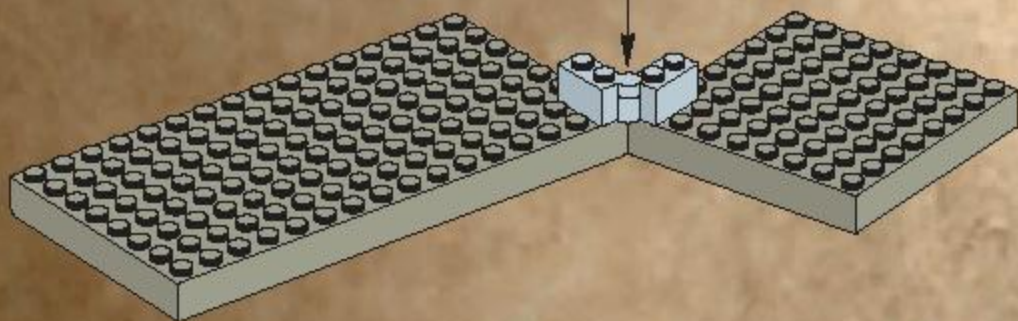

2

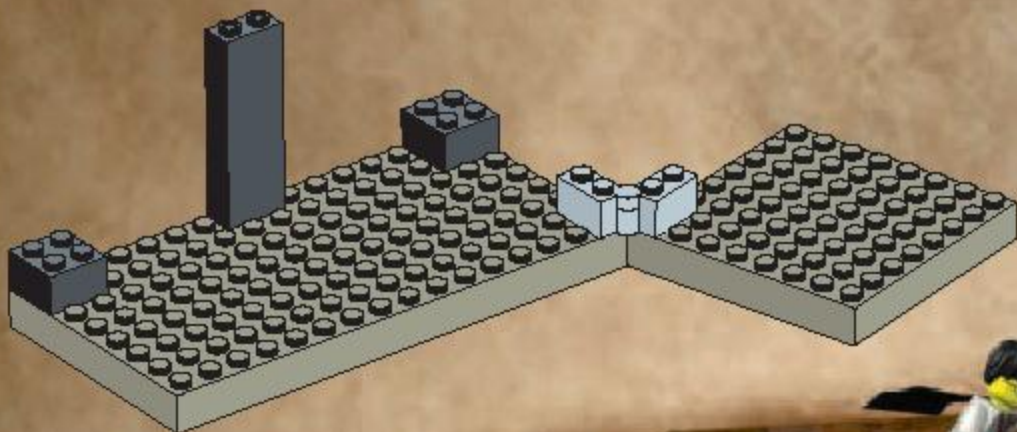

3

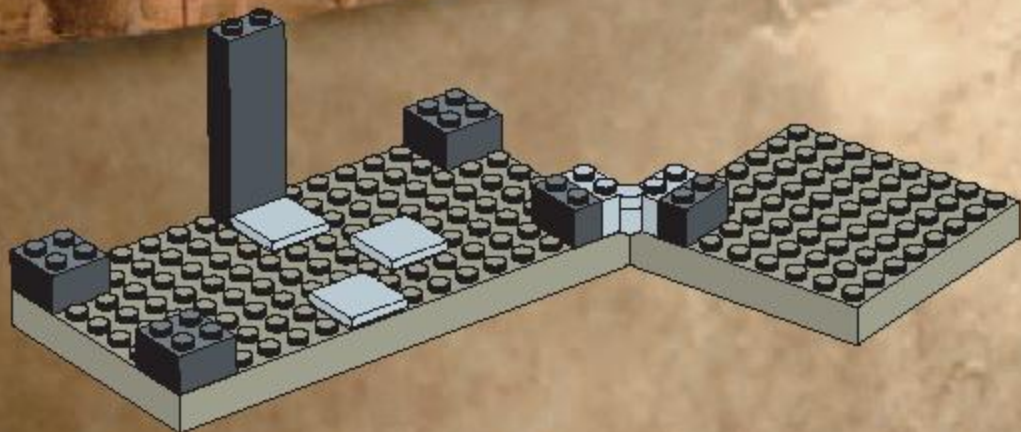

4

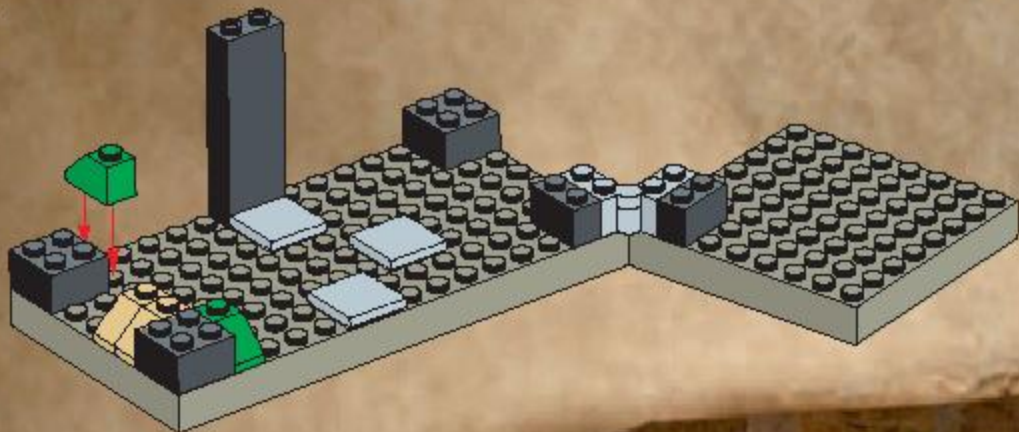

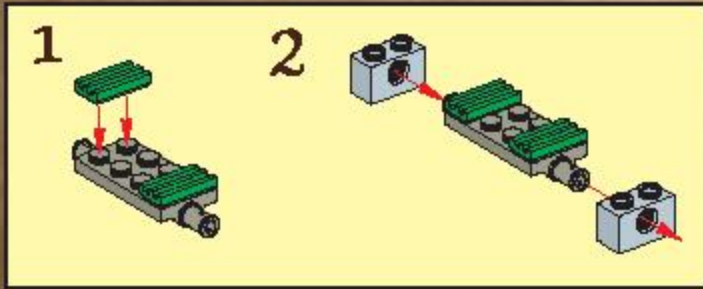

5

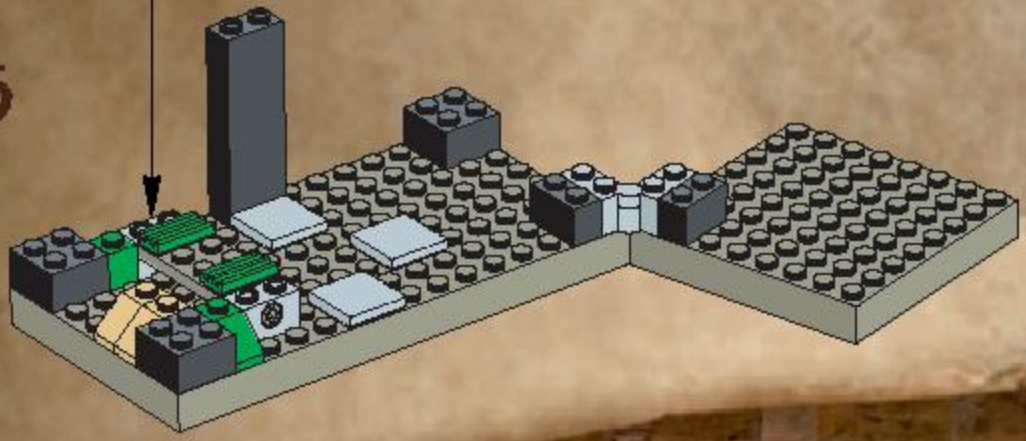

6

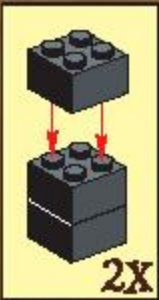
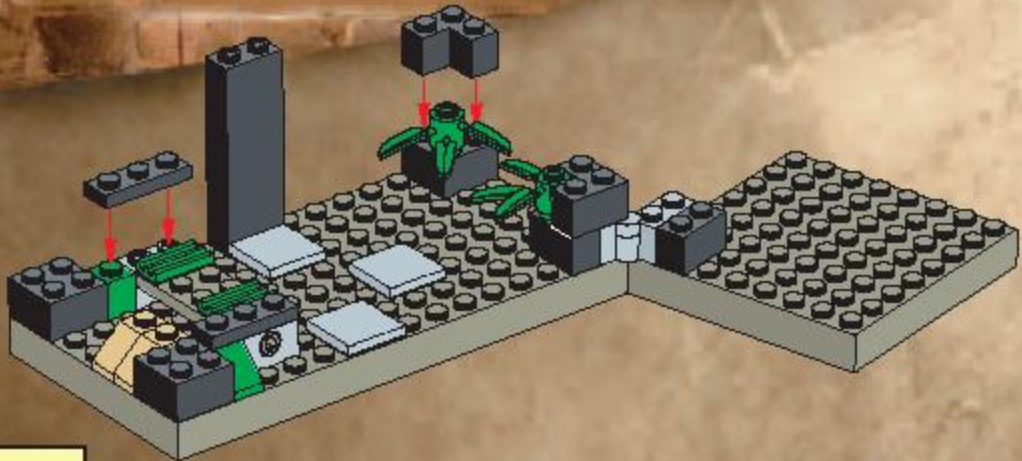

2X

7

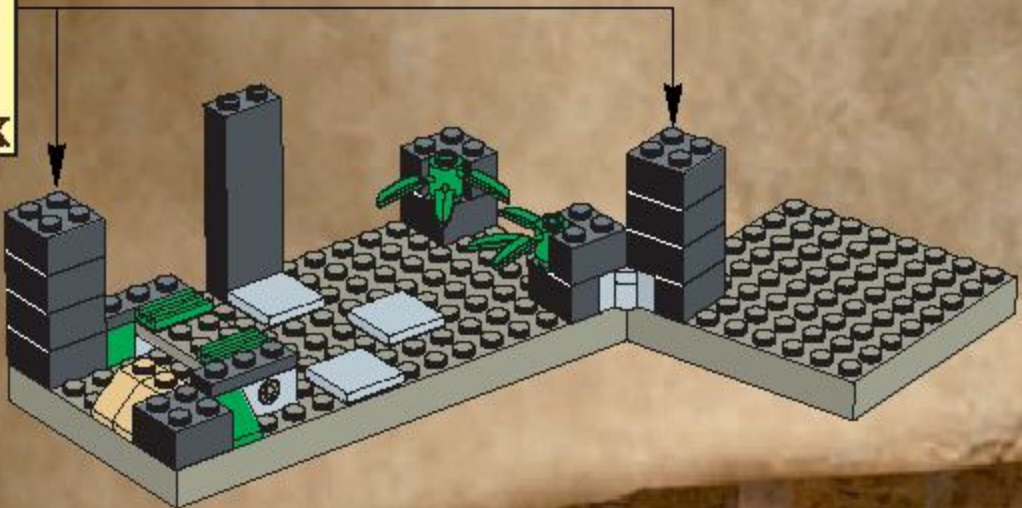

1



3

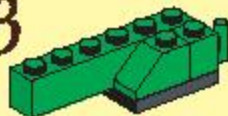

5

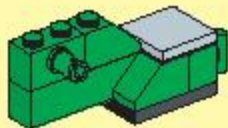

2

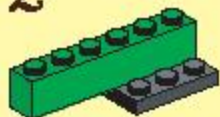

4

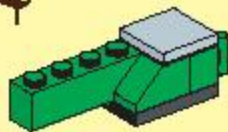

6

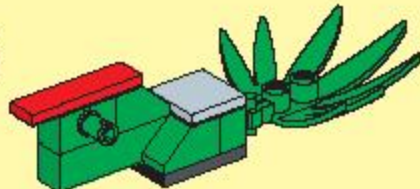

8

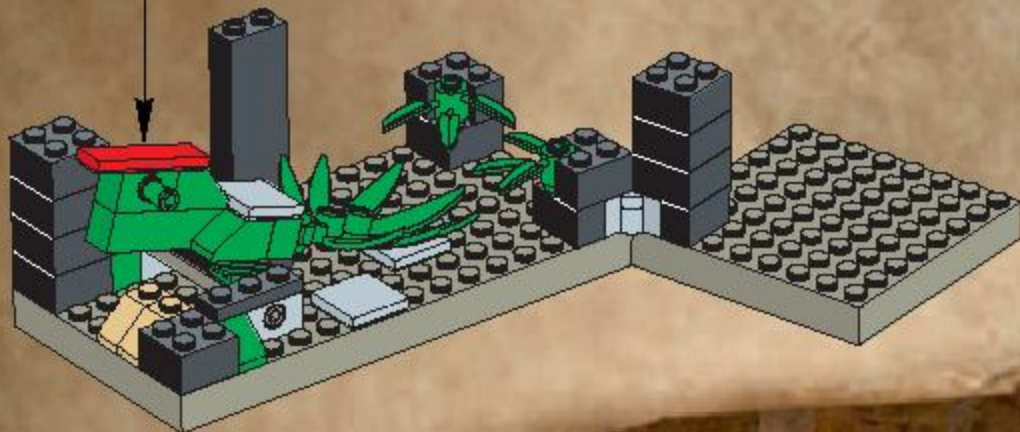

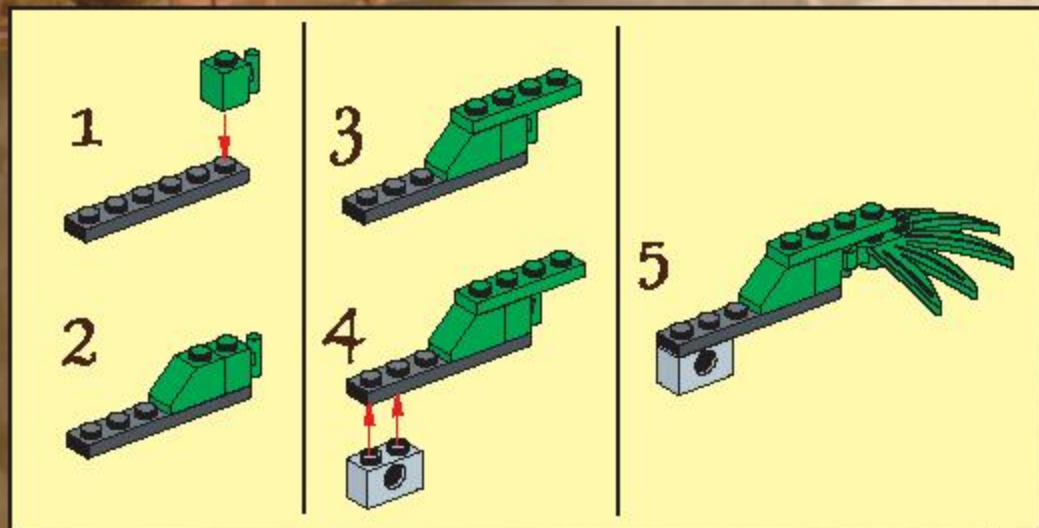

9

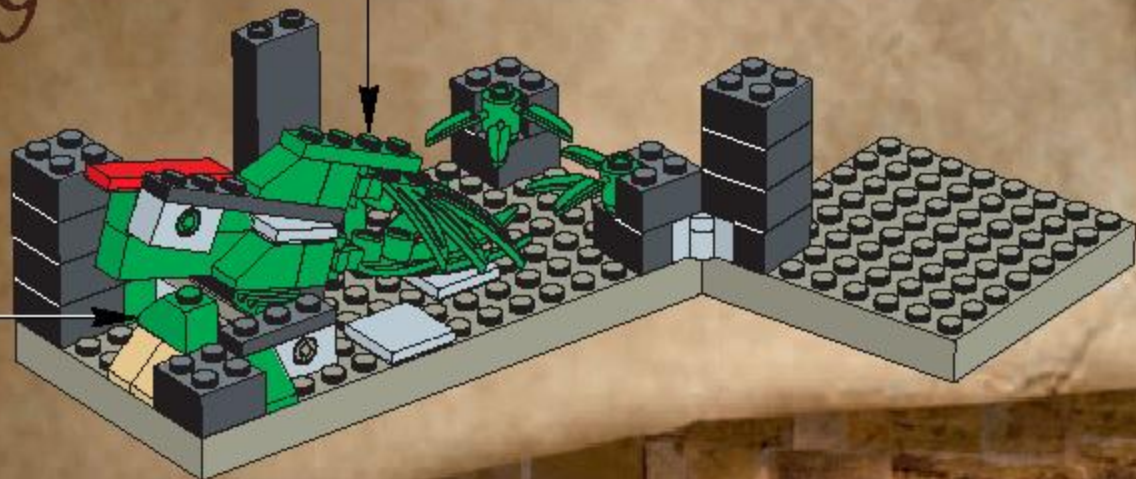

10

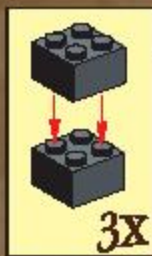
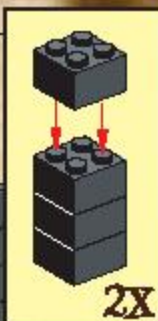
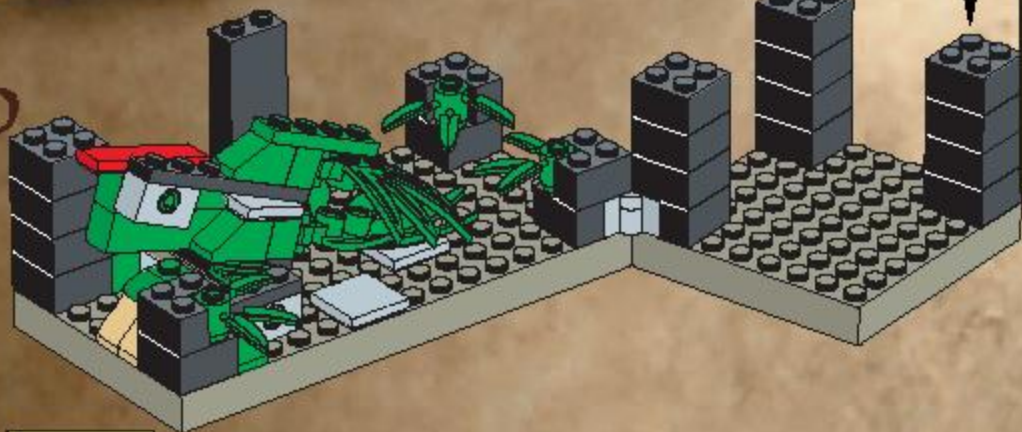

11

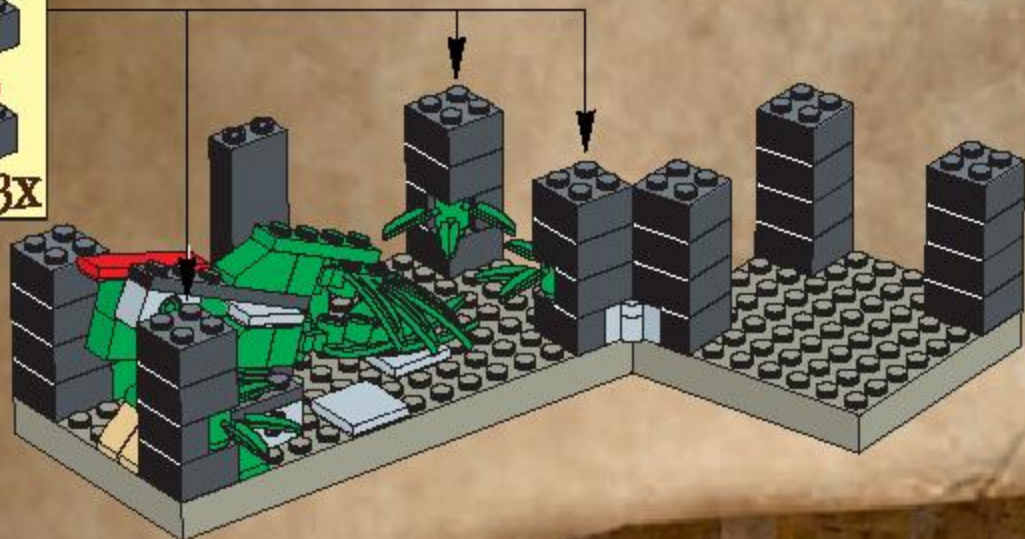

12



13

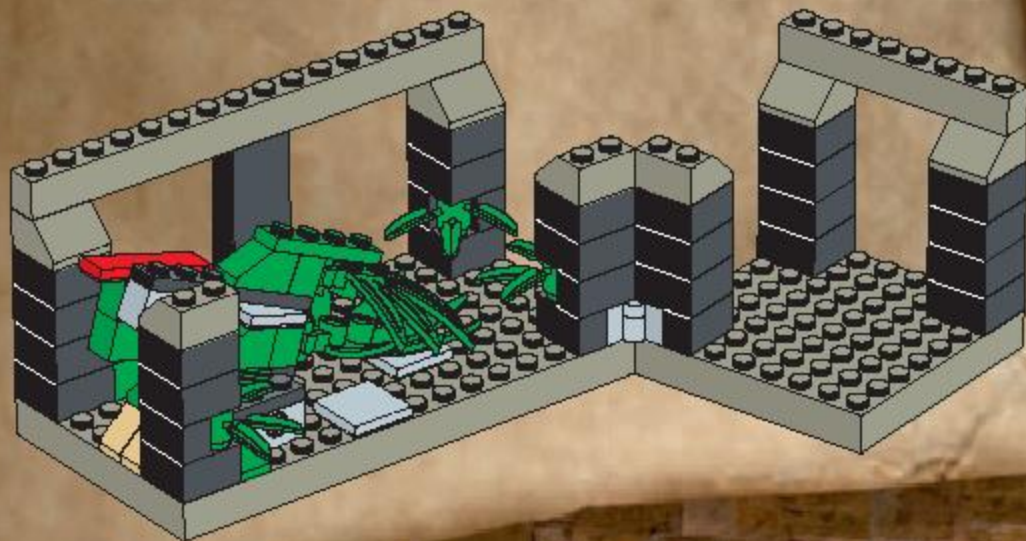

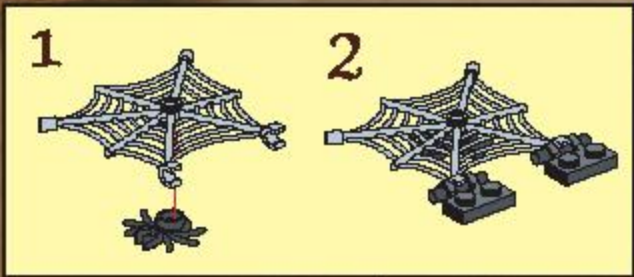

14

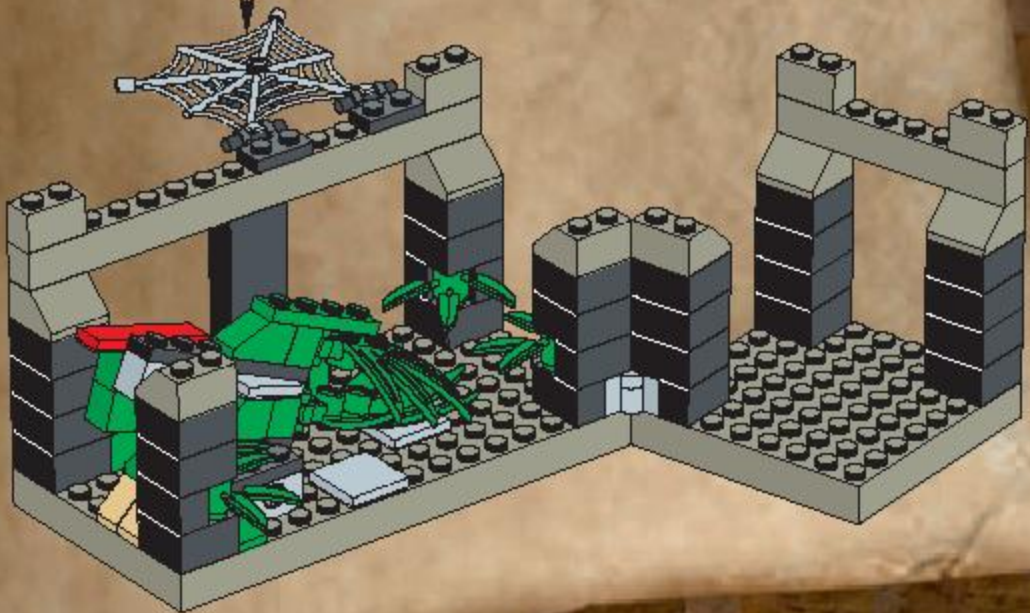

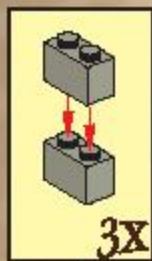
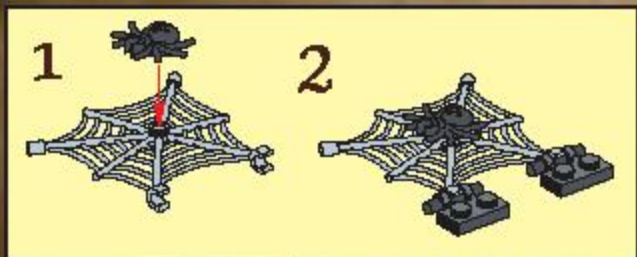

15



12



16

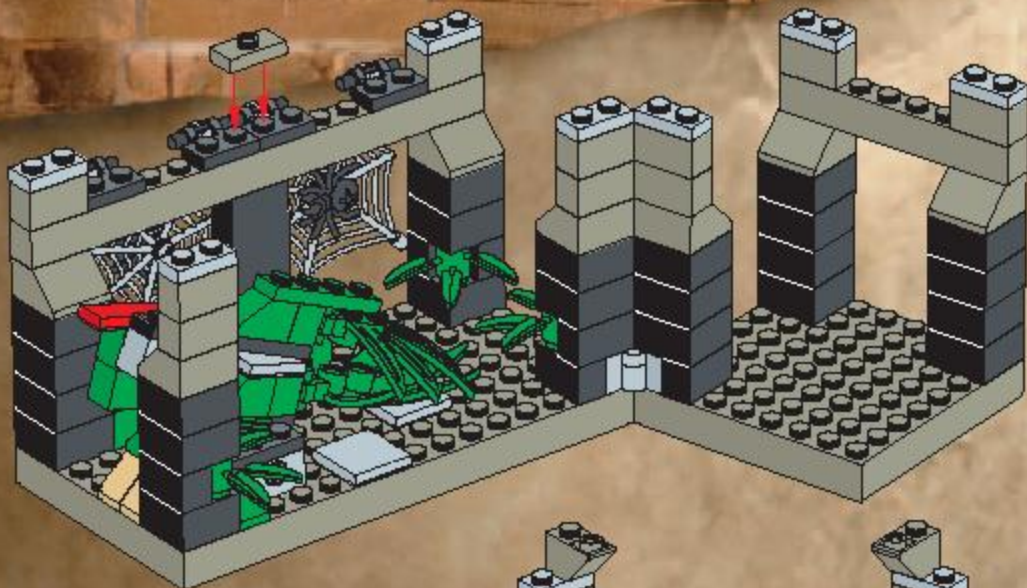

17

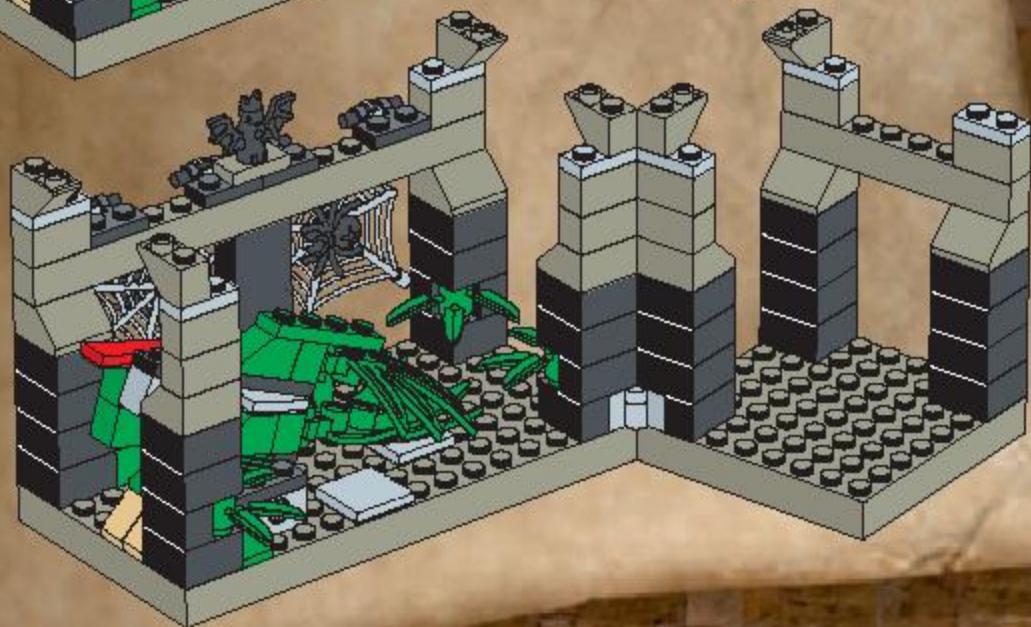

18



19

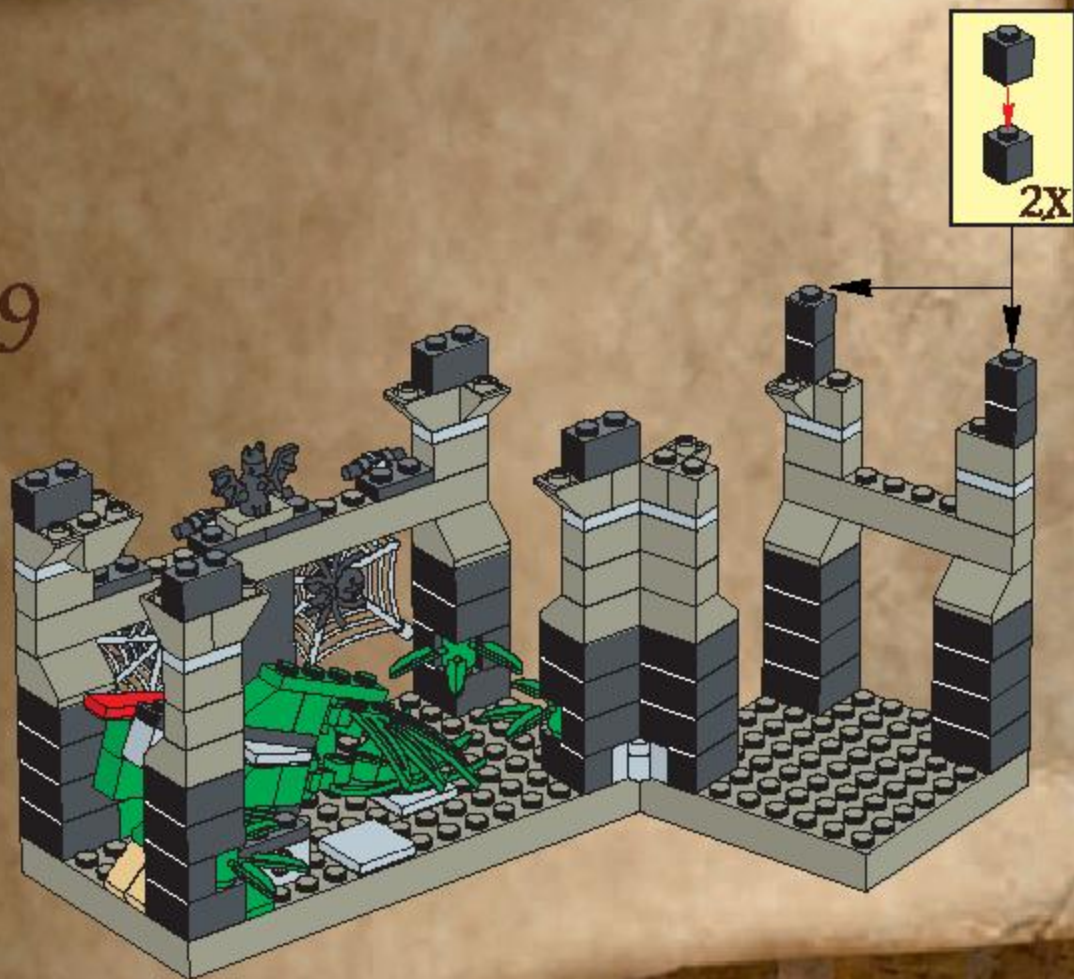

20

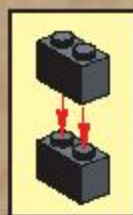

21



22



23

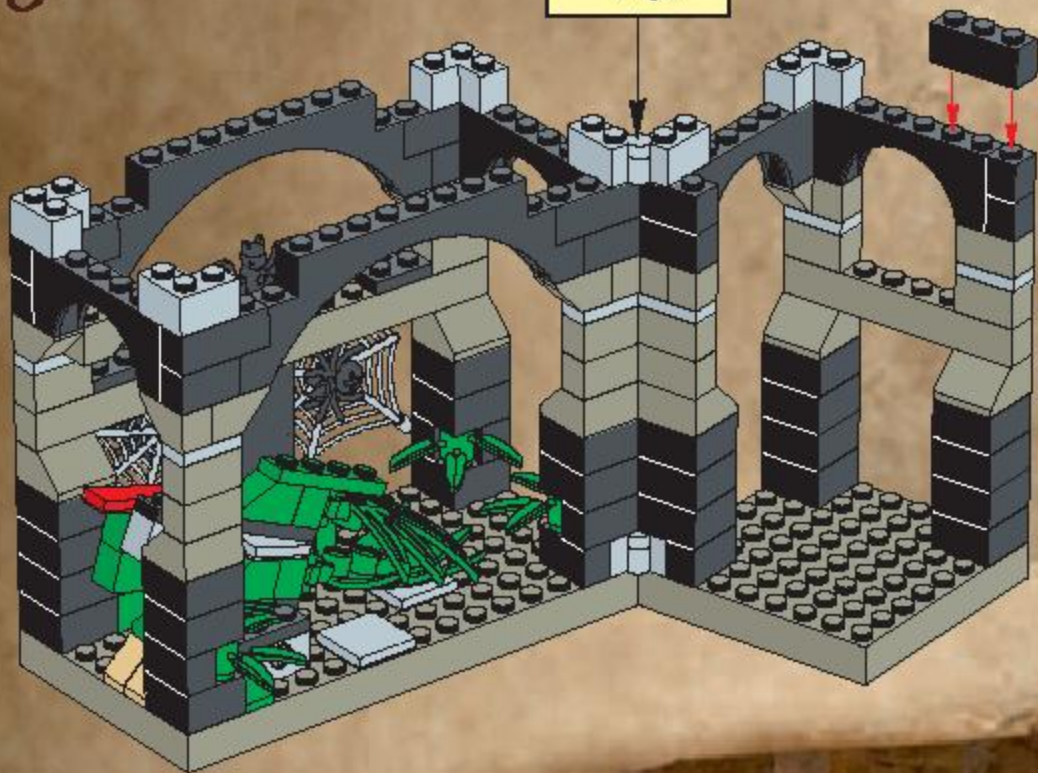
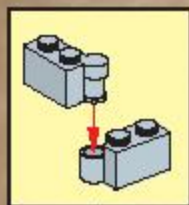

1



2



3

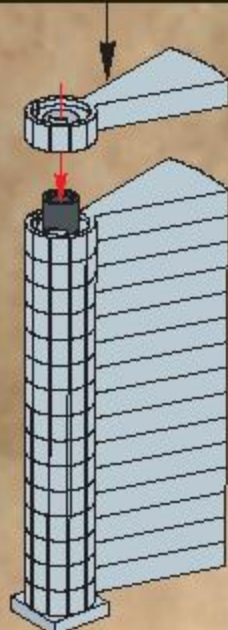

4

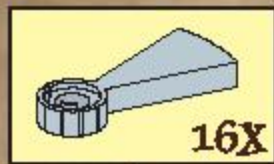

16X

24

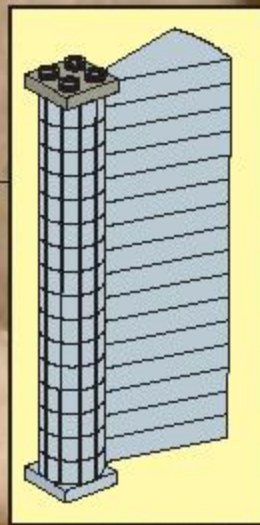

25



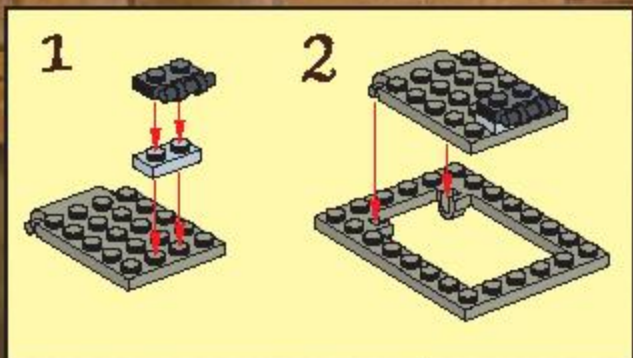

26

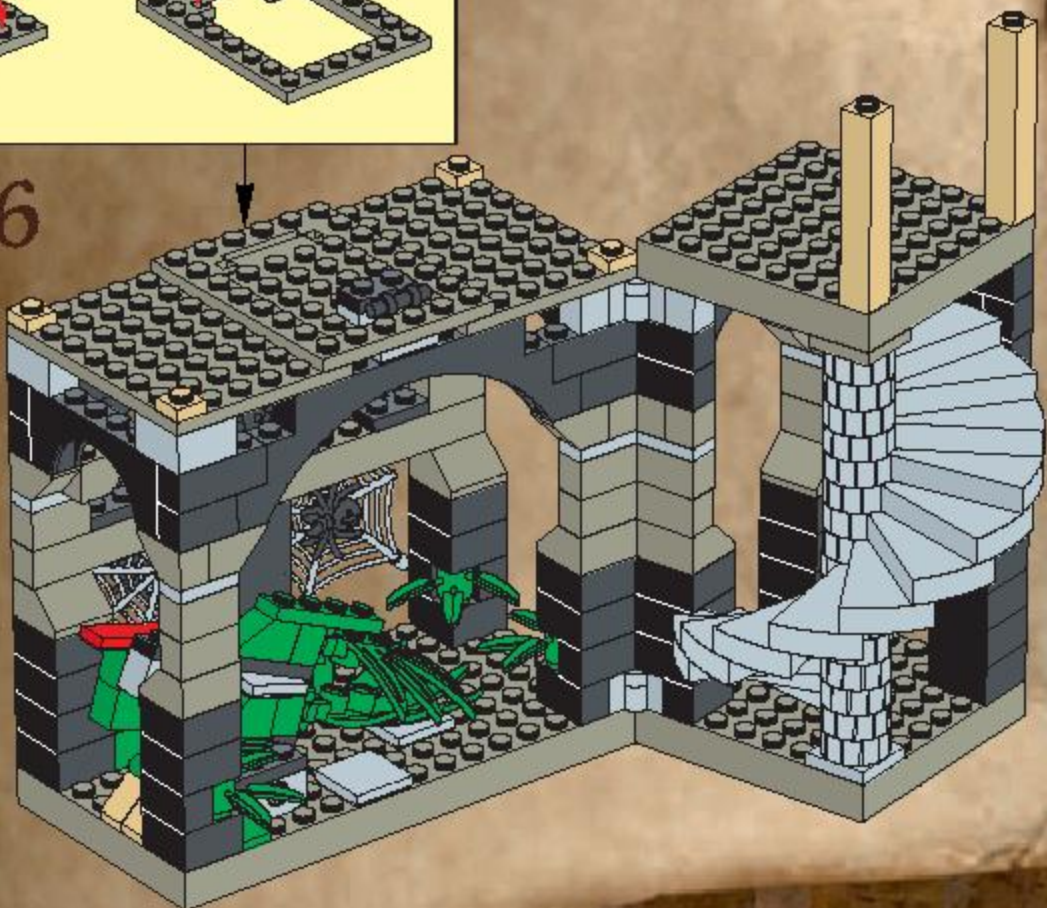

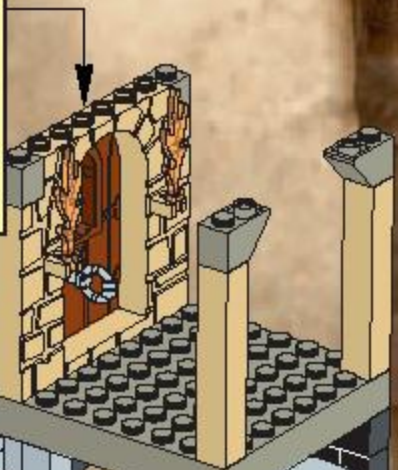

27



28

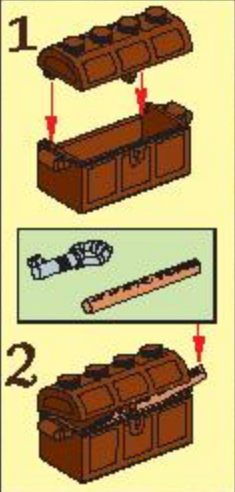



29

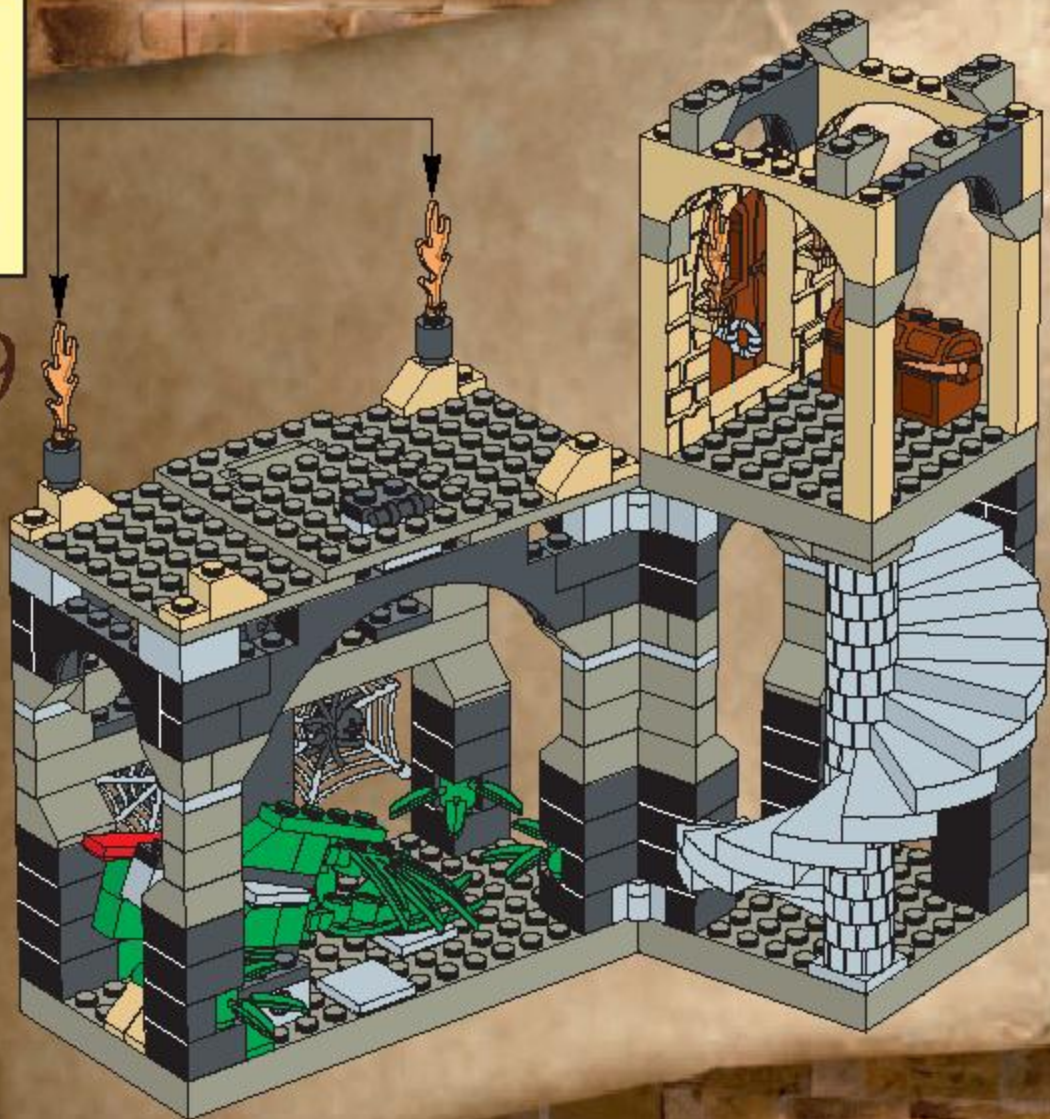

30



31



32



1

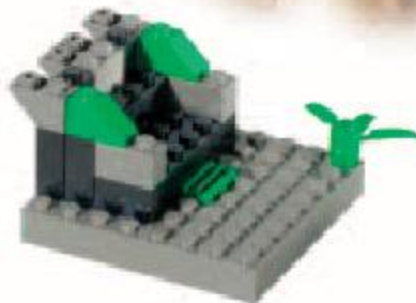

2

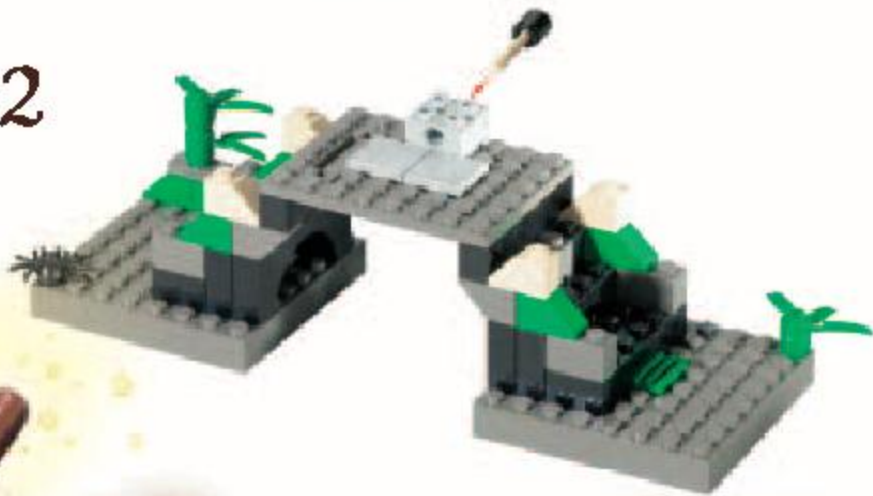

3



4



1



3

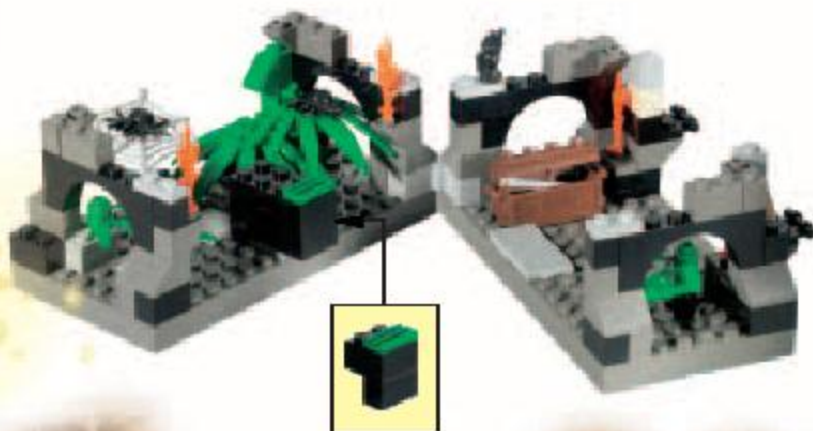

2



4



1

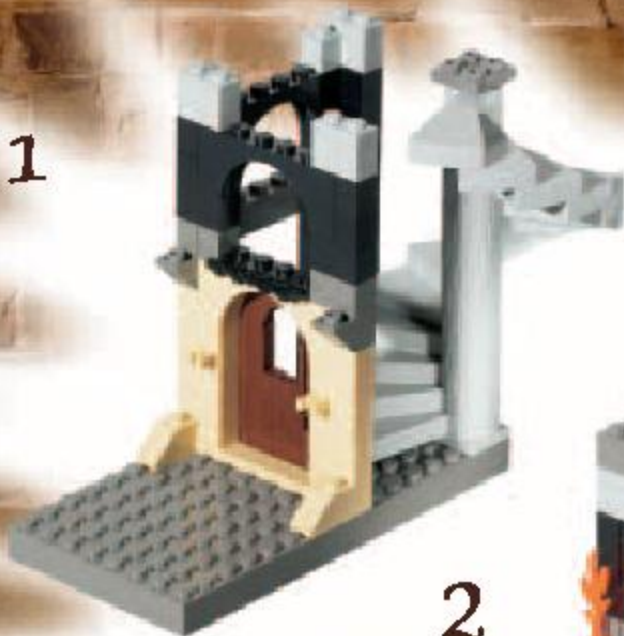

2



3



4



LEGO

SOFT
ware

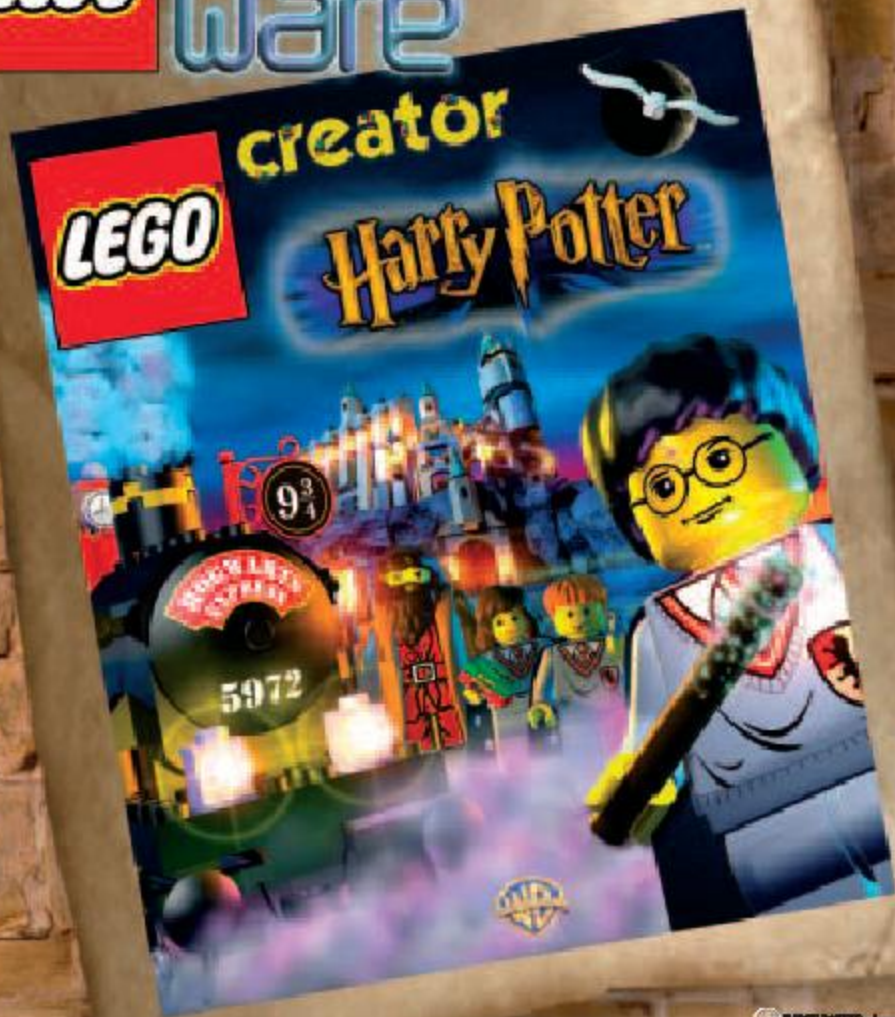

www.harrypotter.com



© HARRY POTTER, characters, names and related indicia are trademarks of Warner Bros. © 2001.
HARRY POTTER, characters, names and related indicia are trademarks of and © Warner Bros.
(TM)
LEGO M.L.E.™ & © 2001 Warner Bros.