

LEGO

VIKINGS

7018

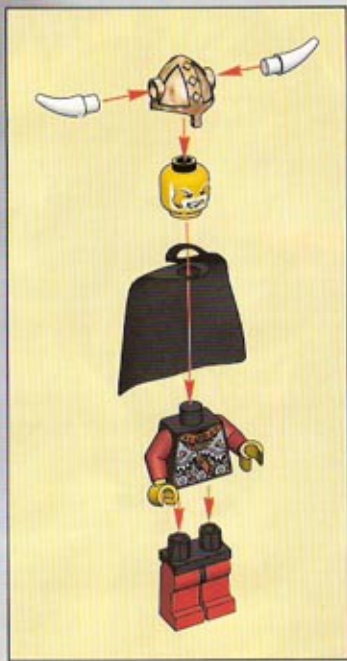



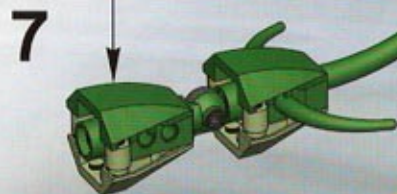
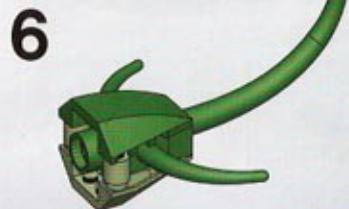

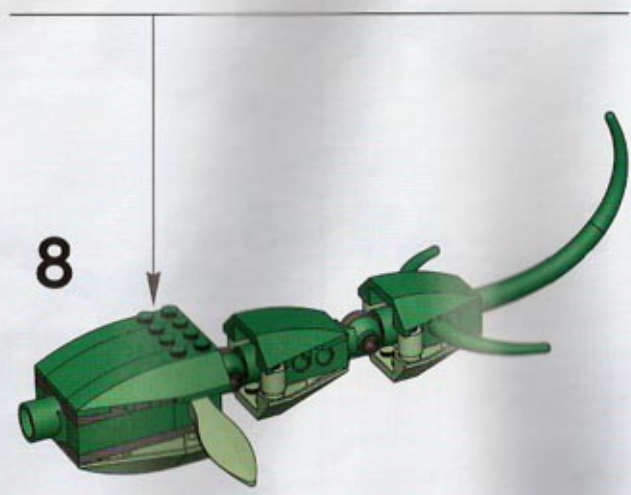
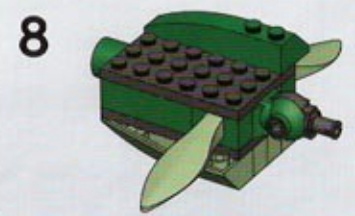
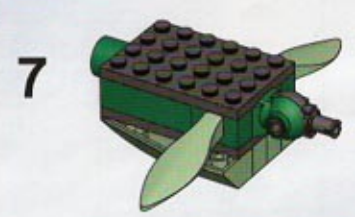
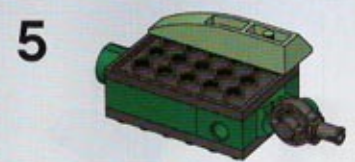
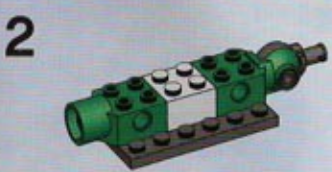

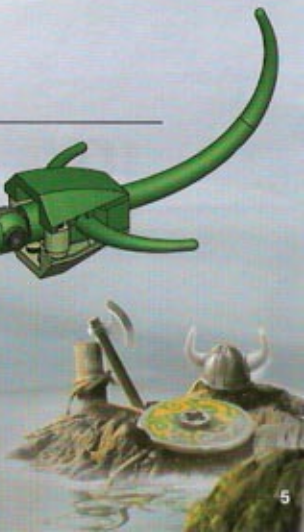
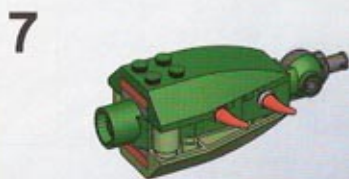
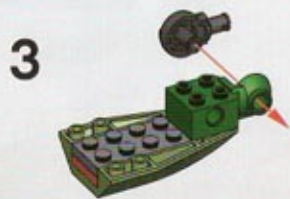
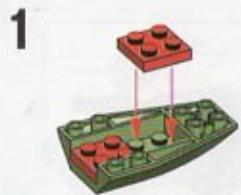

1



2



3



4



5



10

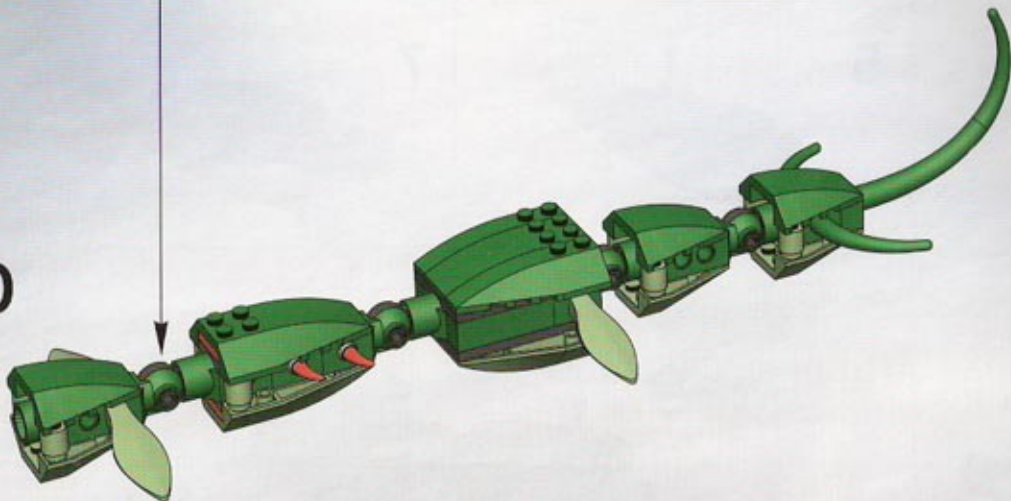

1

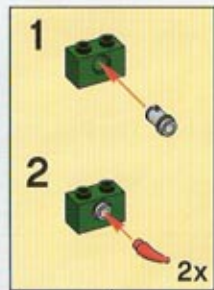

2



1



2



3



4



5



3



4

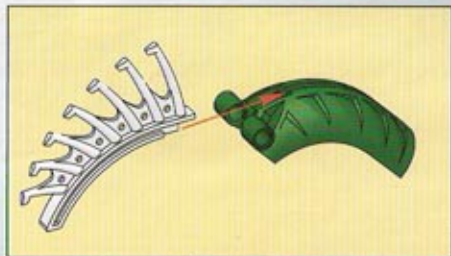
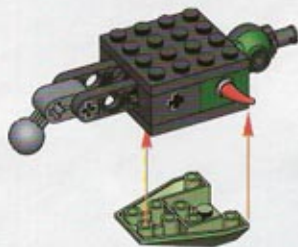

5

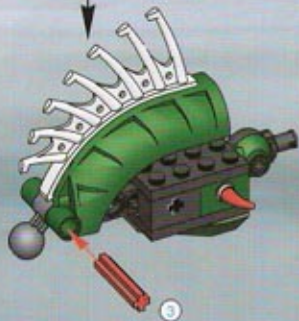



11

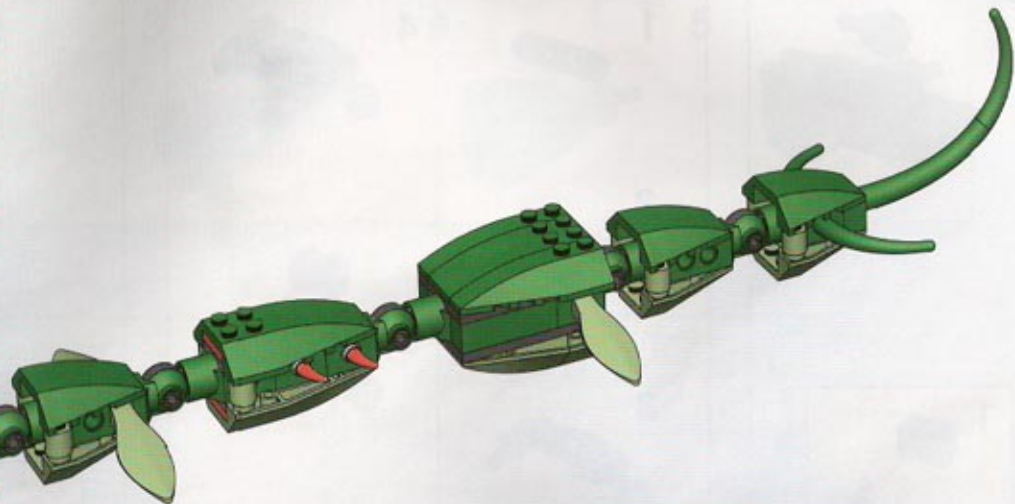
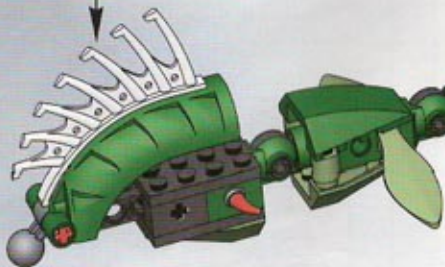

1

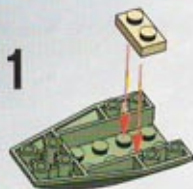

2



1



2



3



3



4



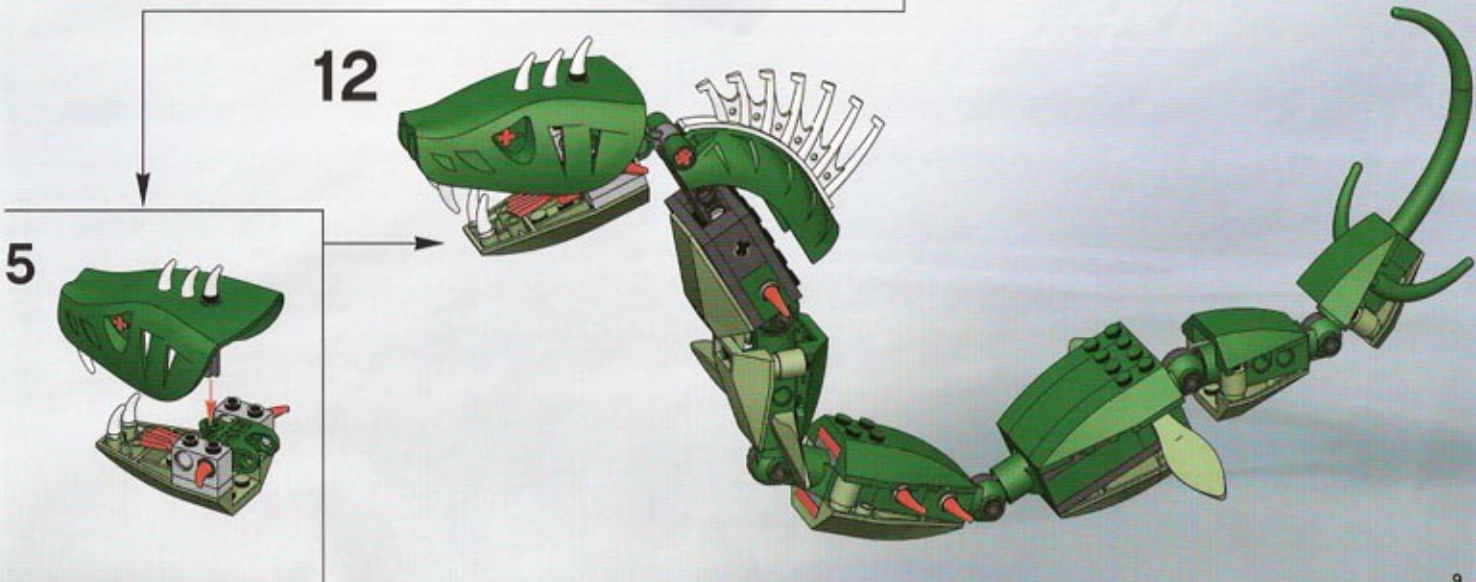
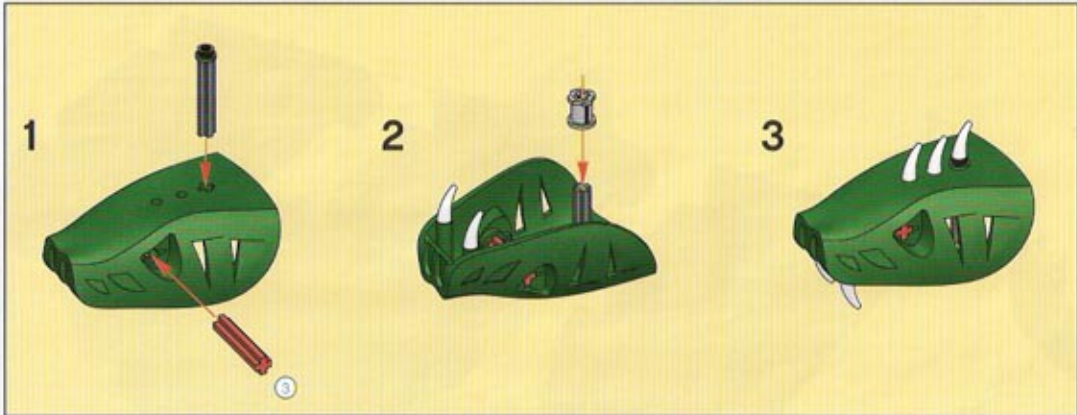



1



2

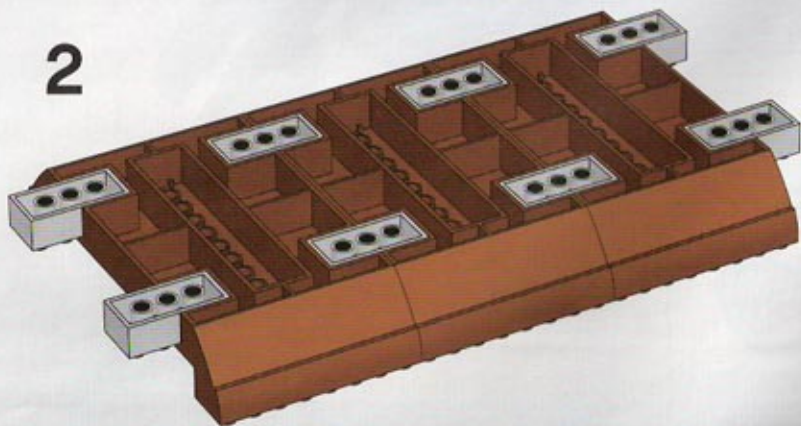

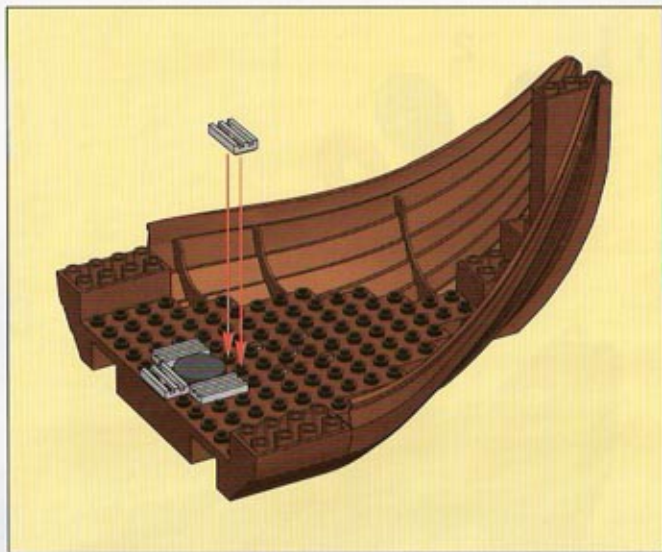

3

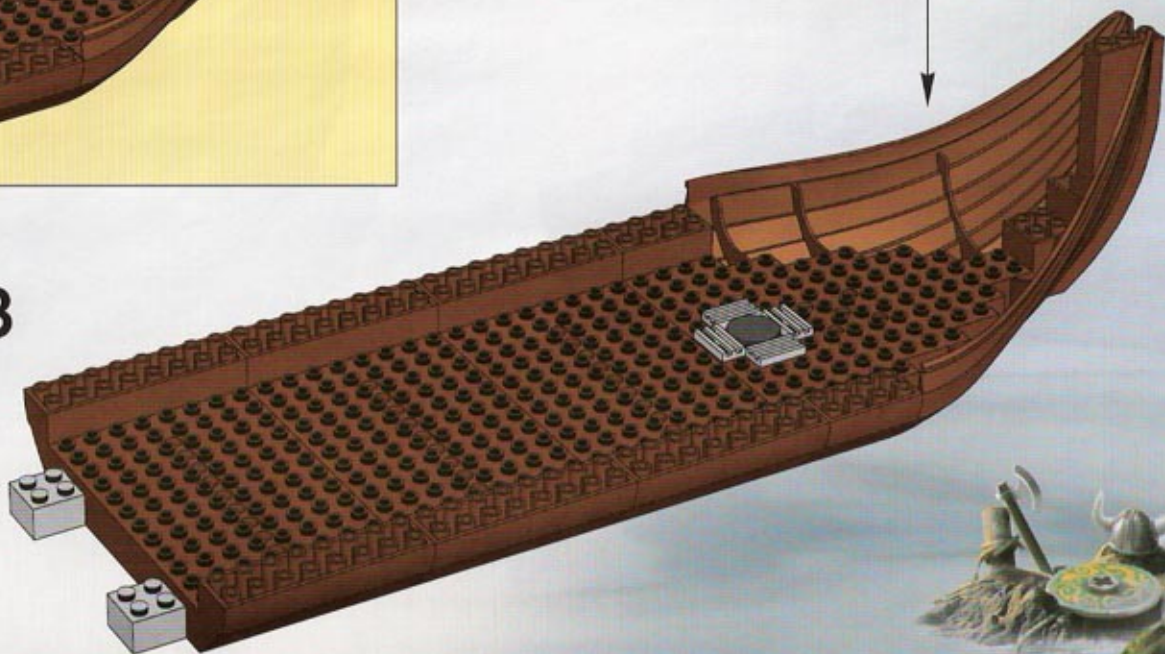

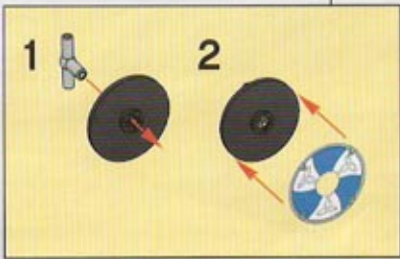
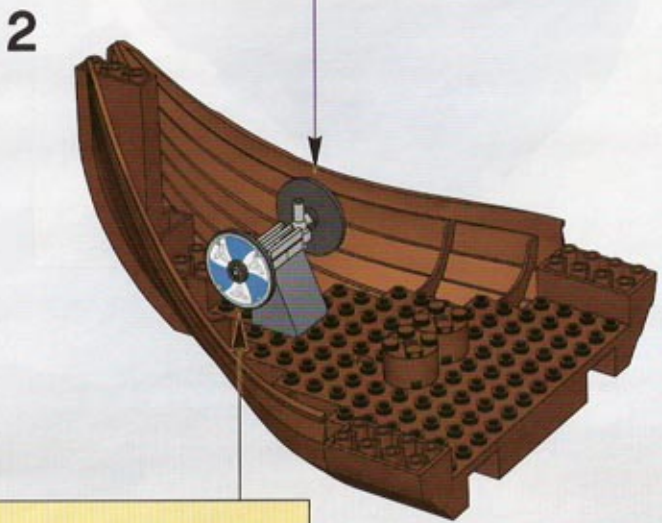
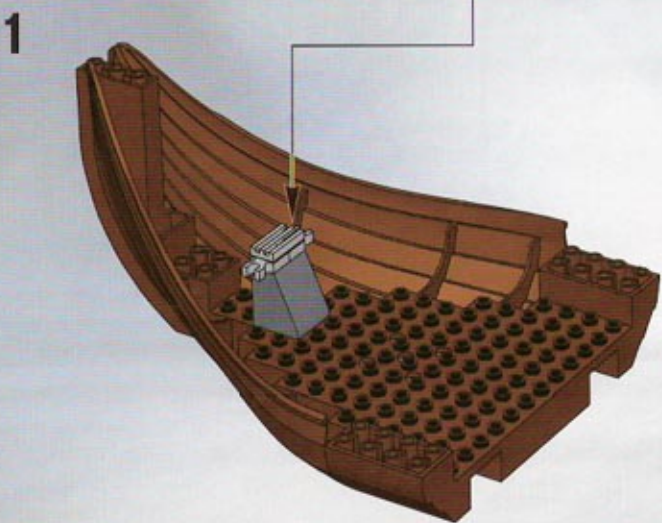
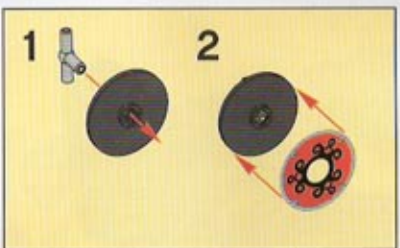

3

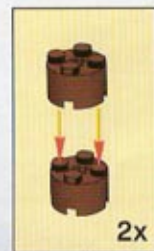
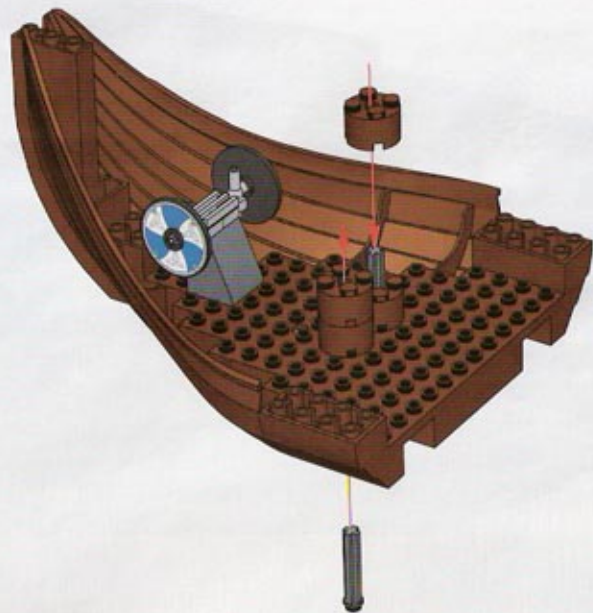

4

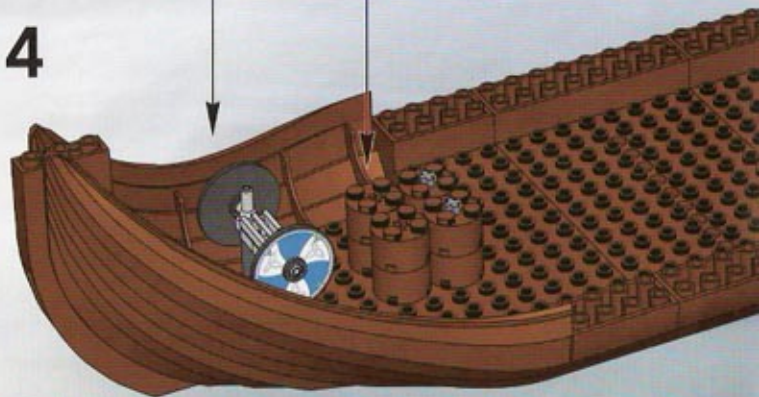

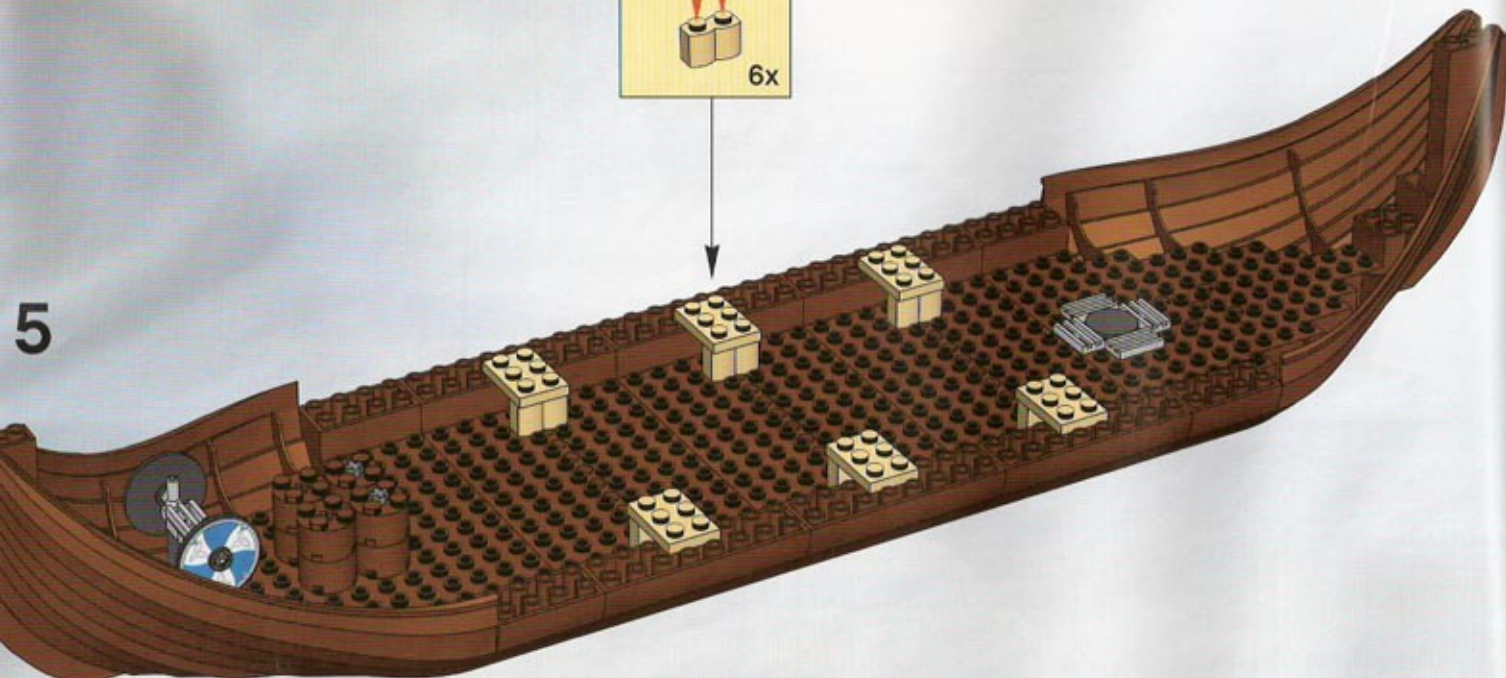
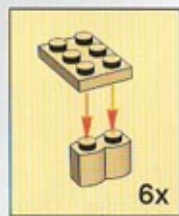

6

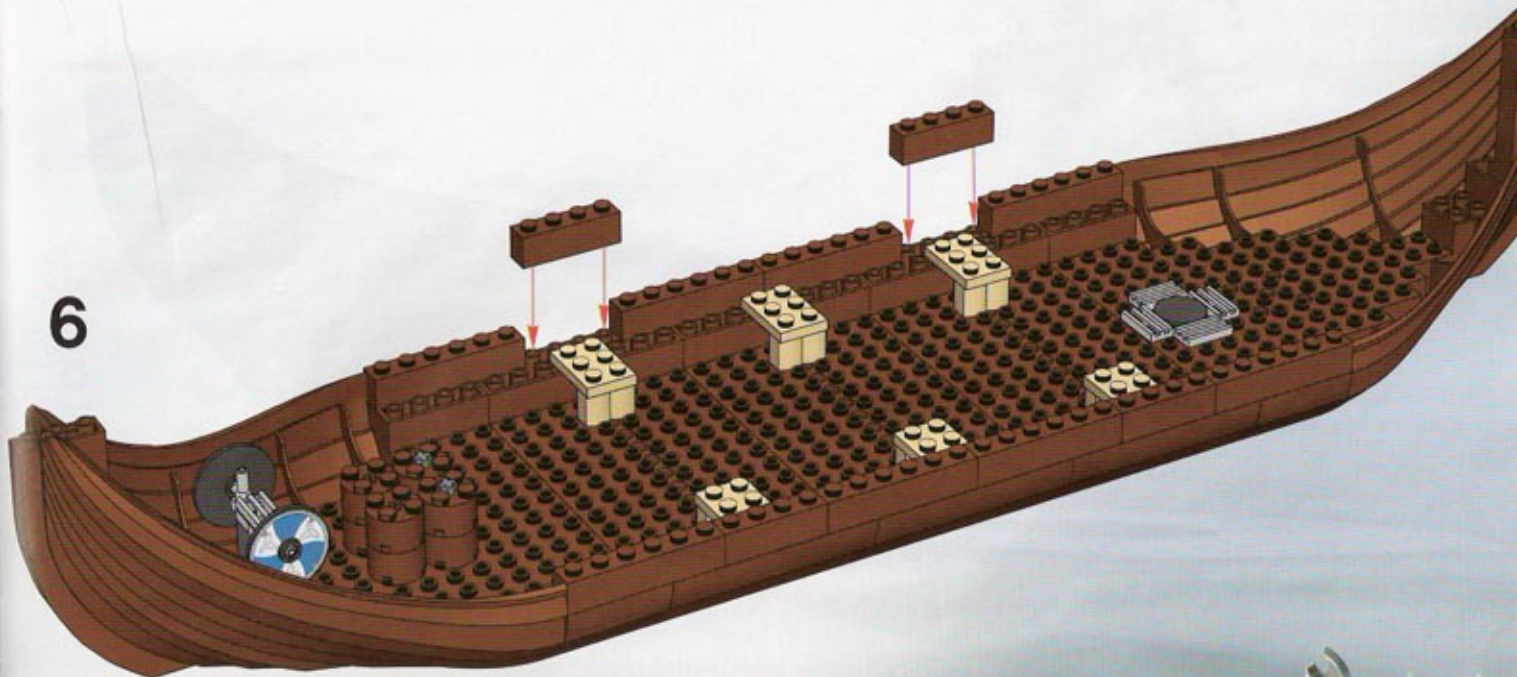

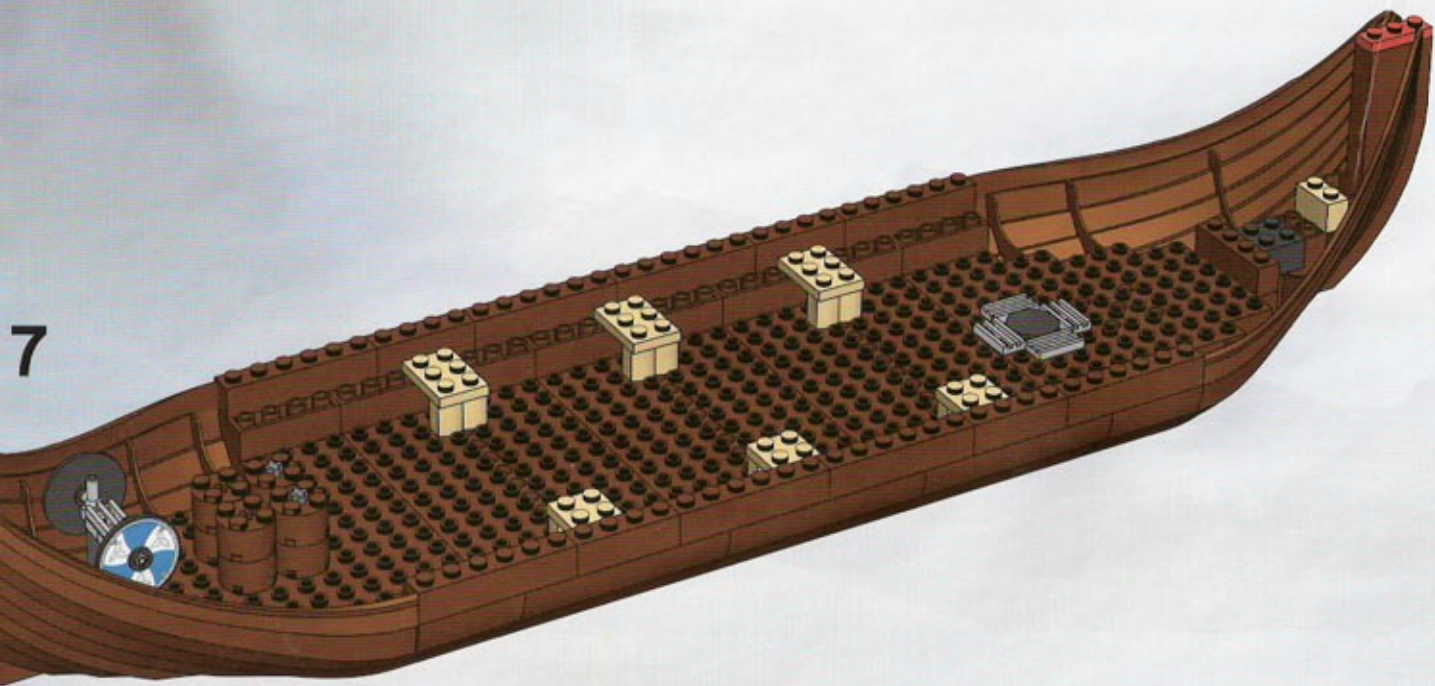

8

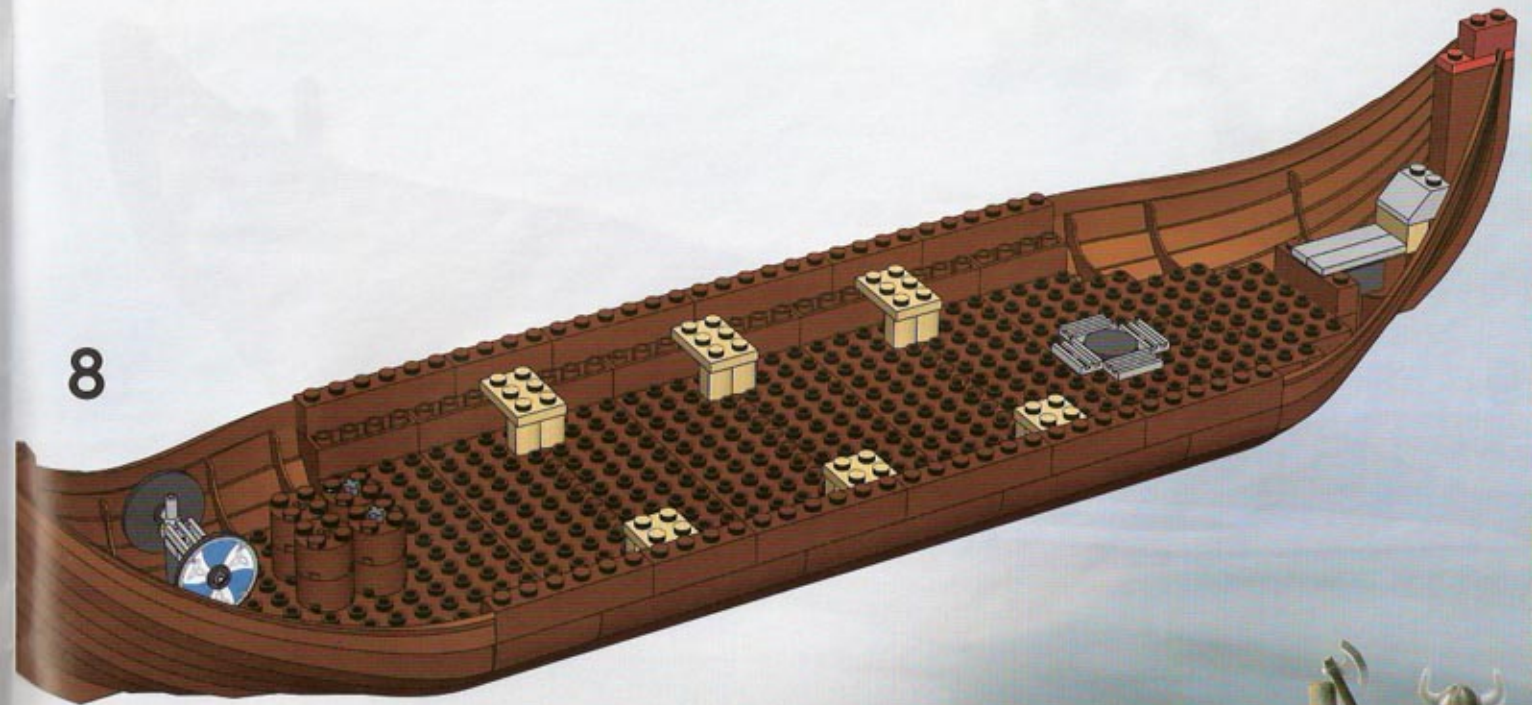

9

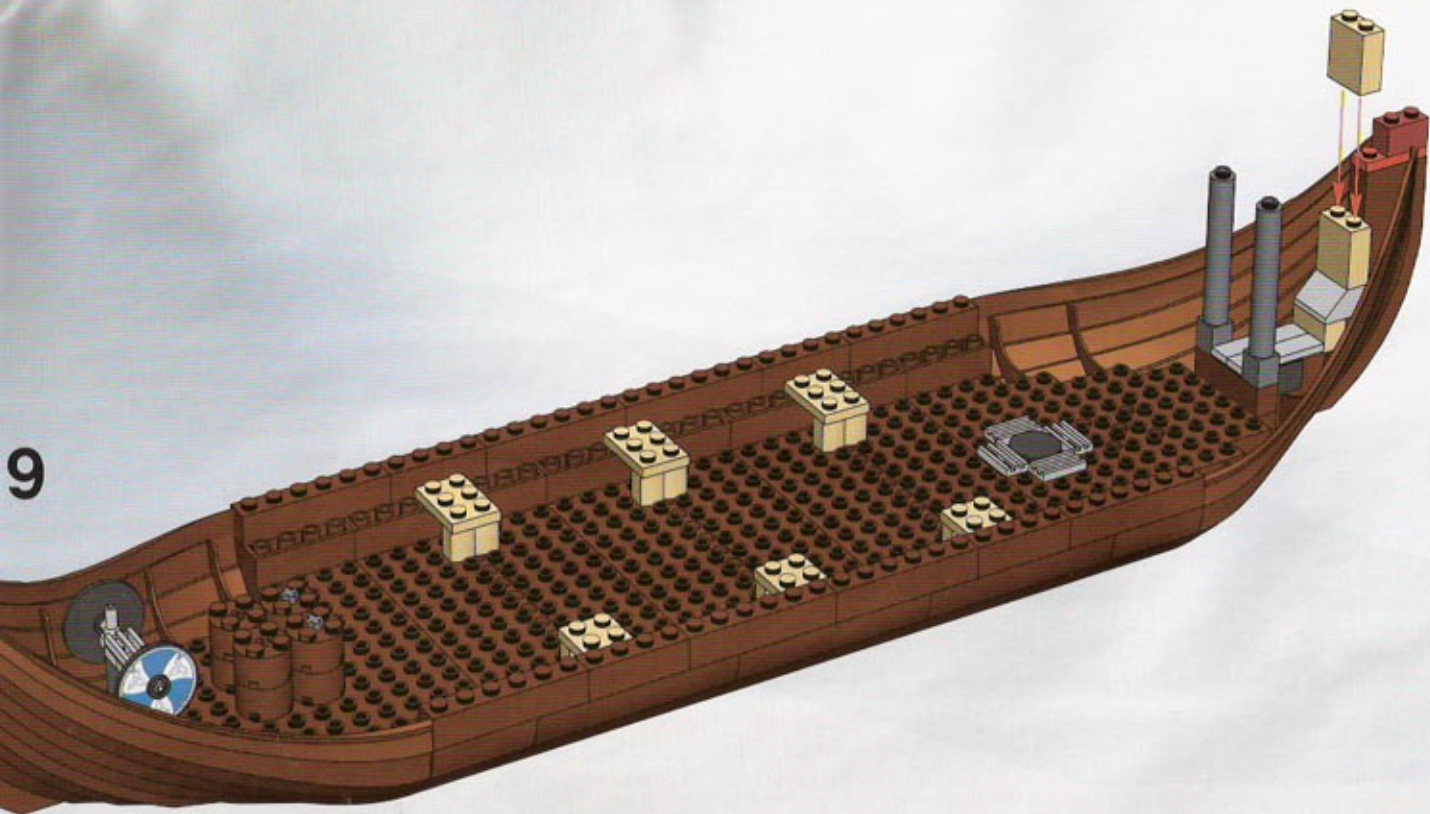

10

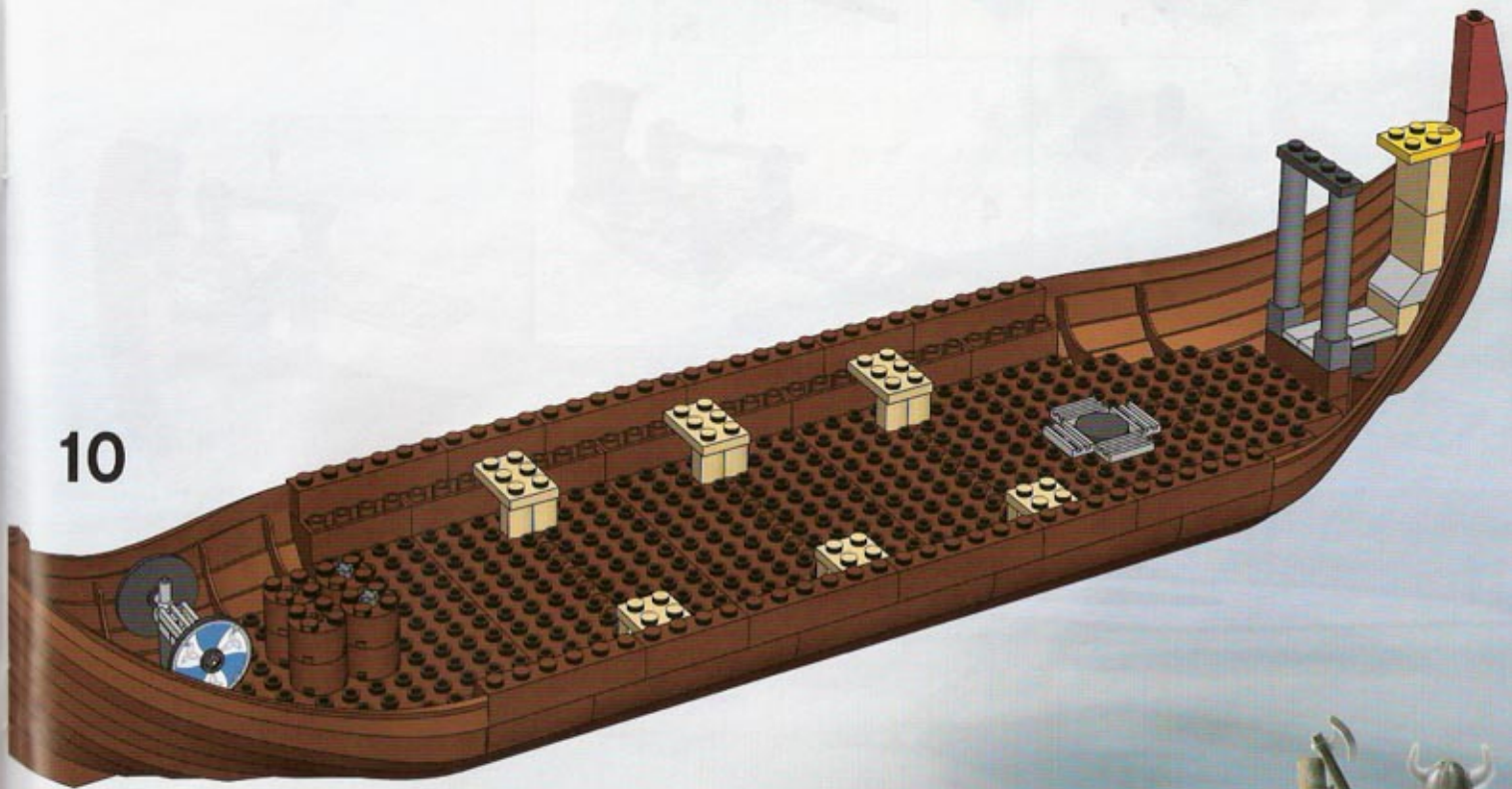

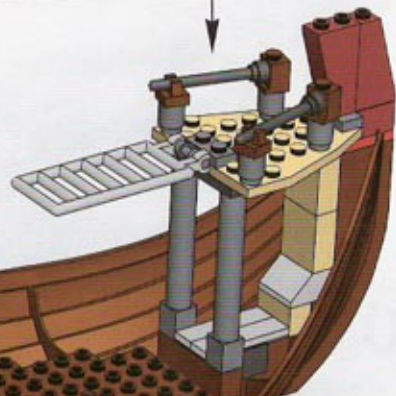
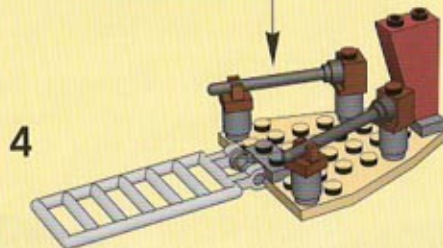
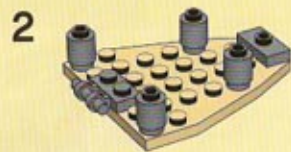
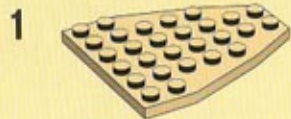

11

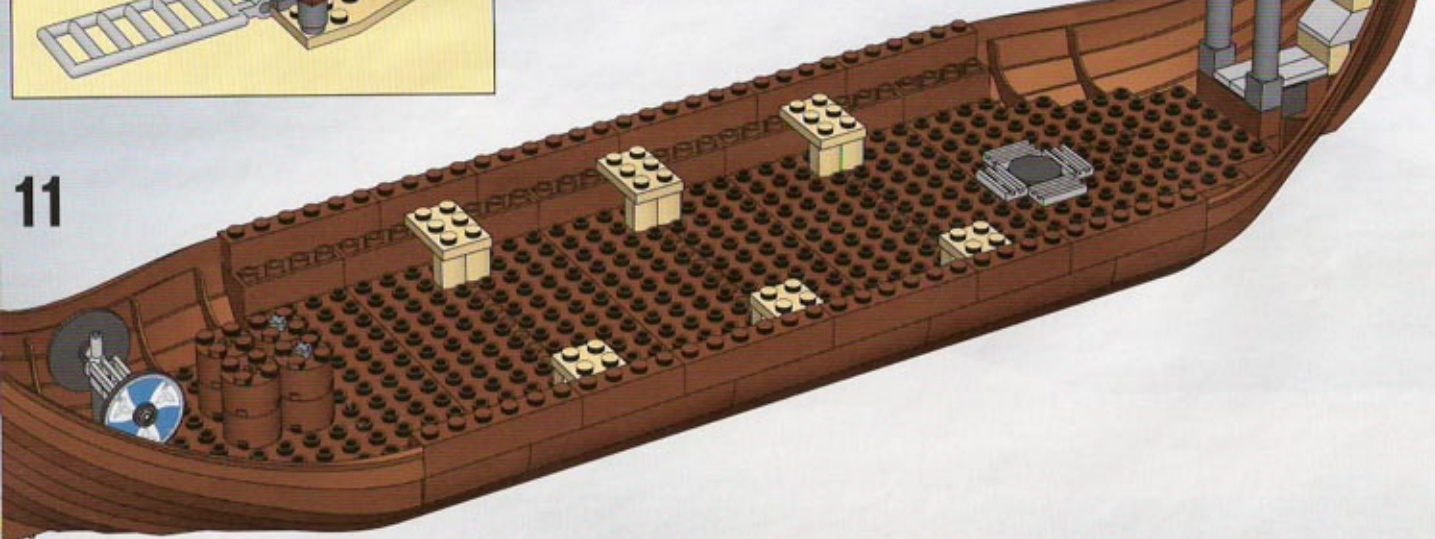

12

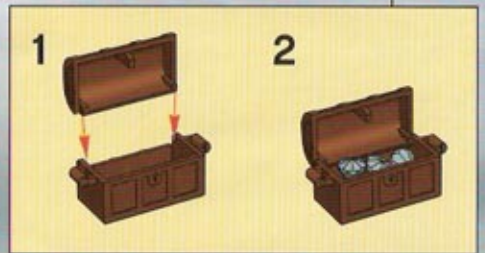
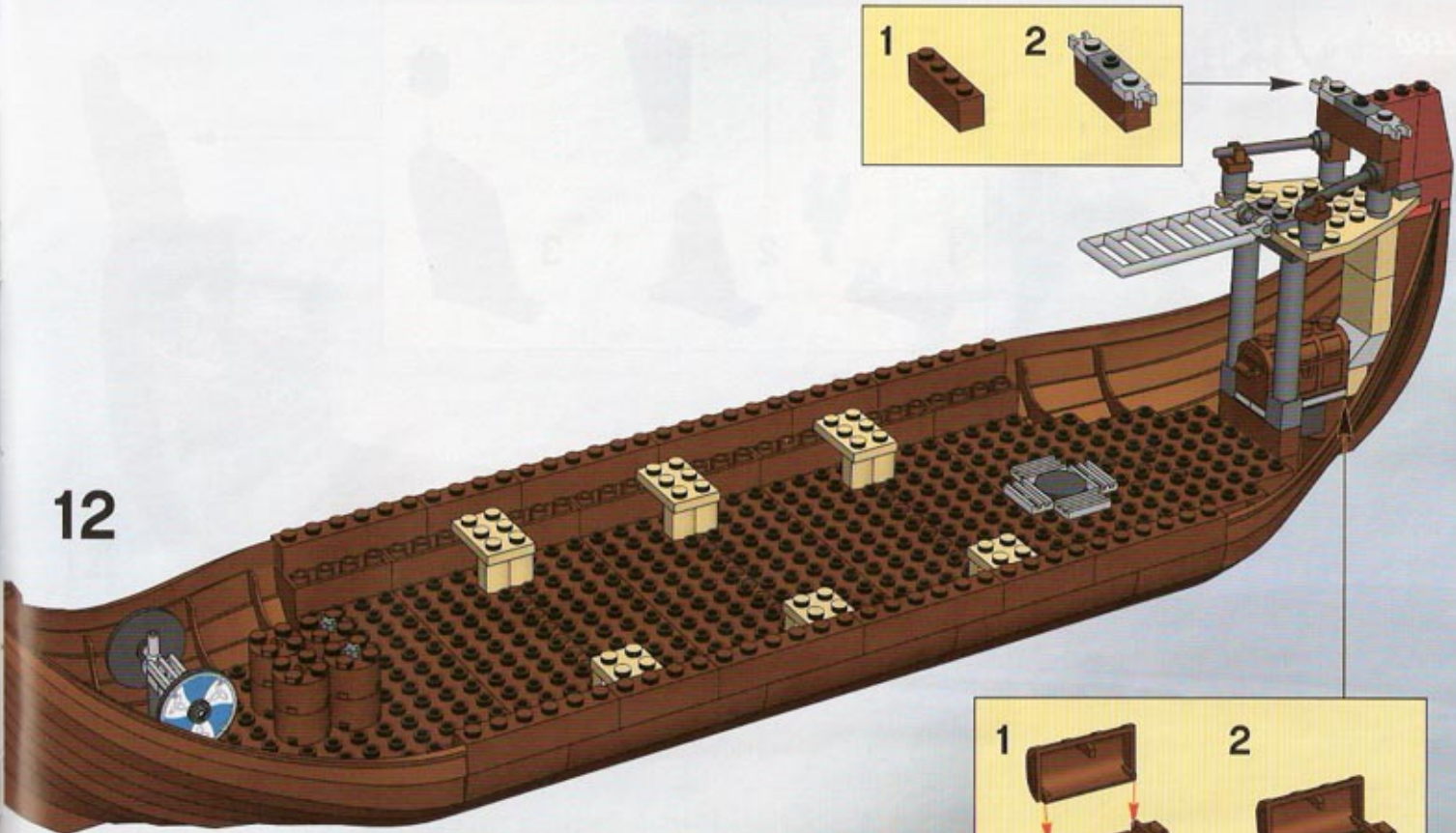
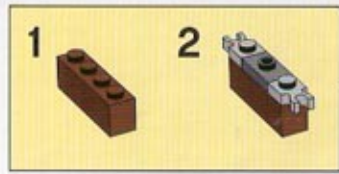

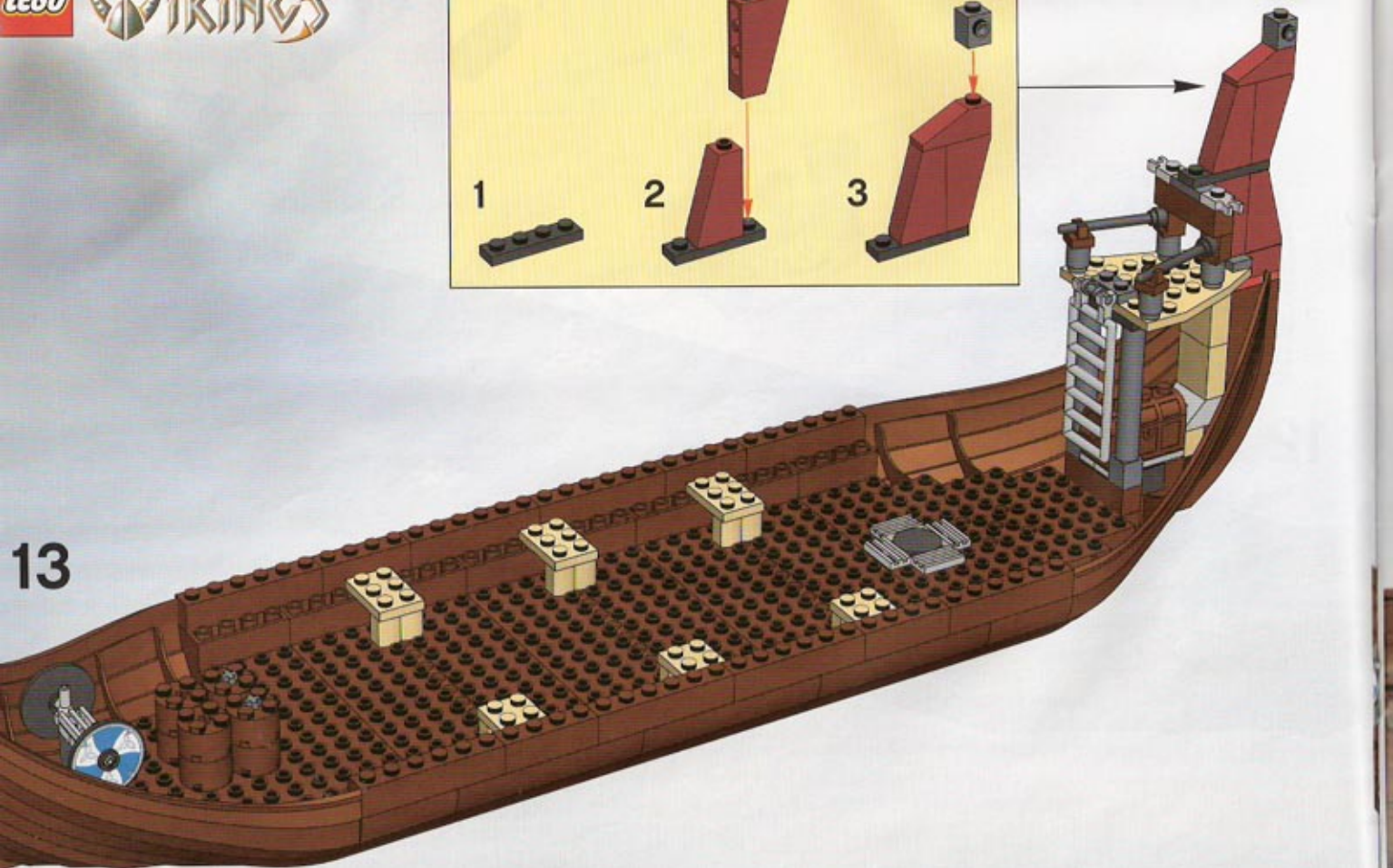
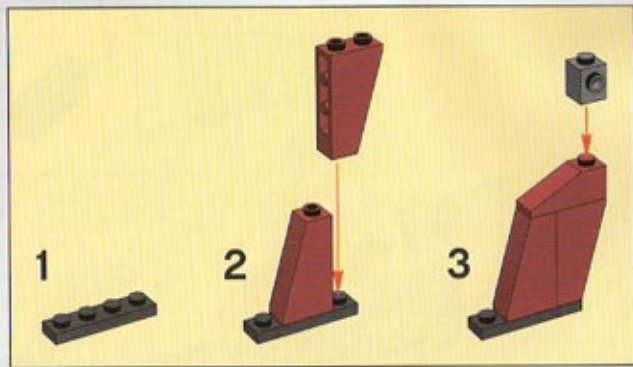

14

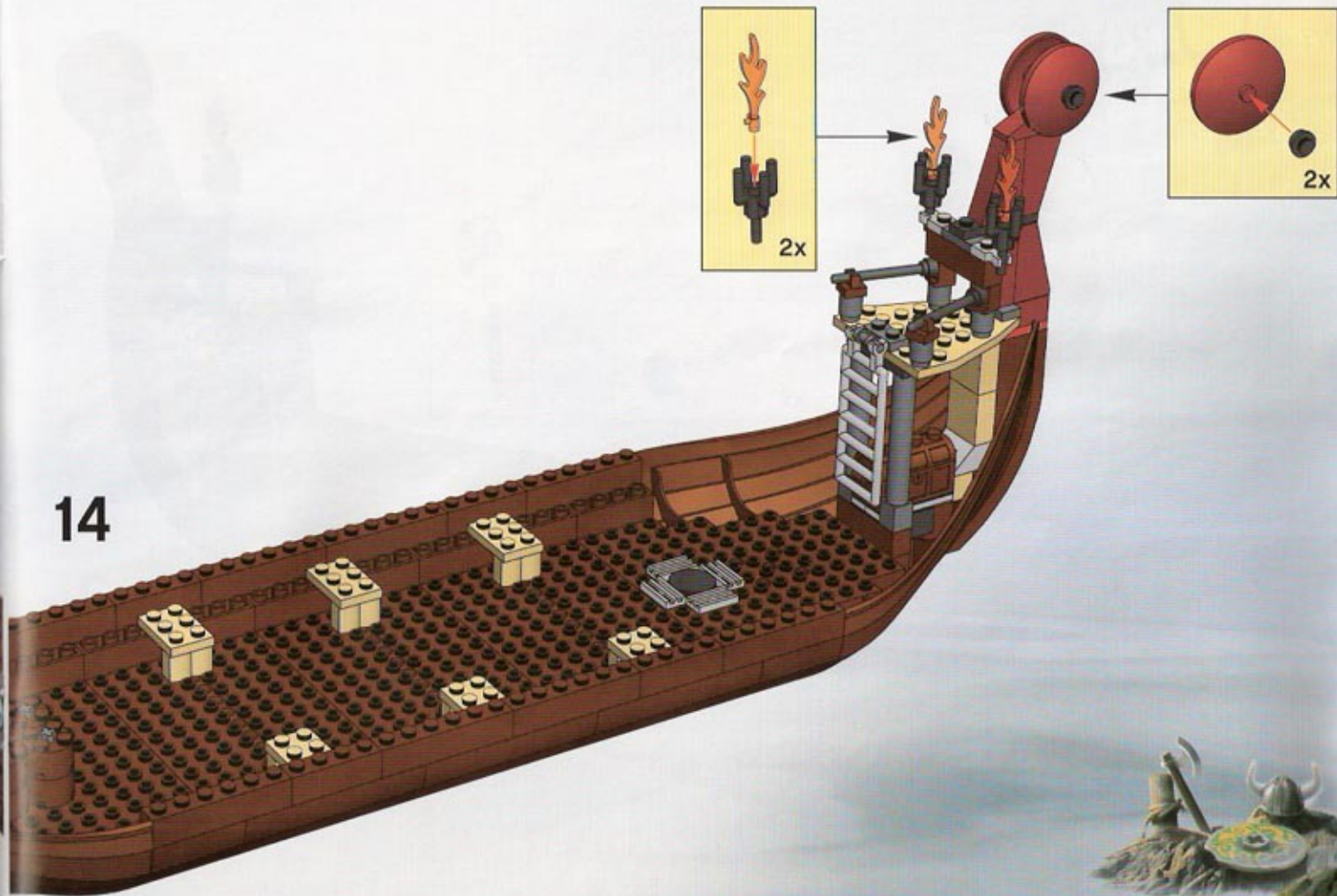

15



16

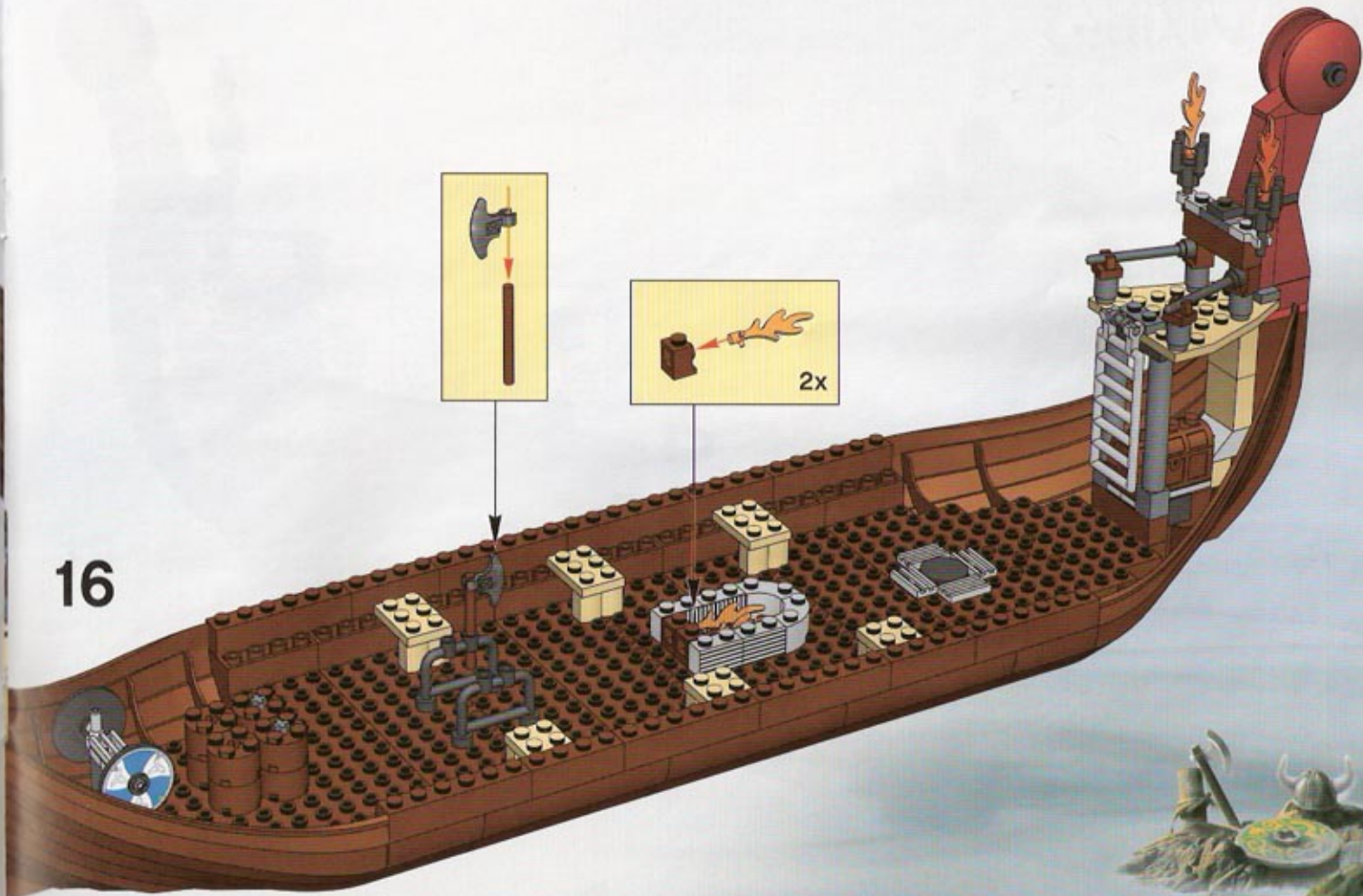
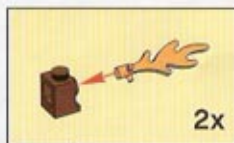

17



18

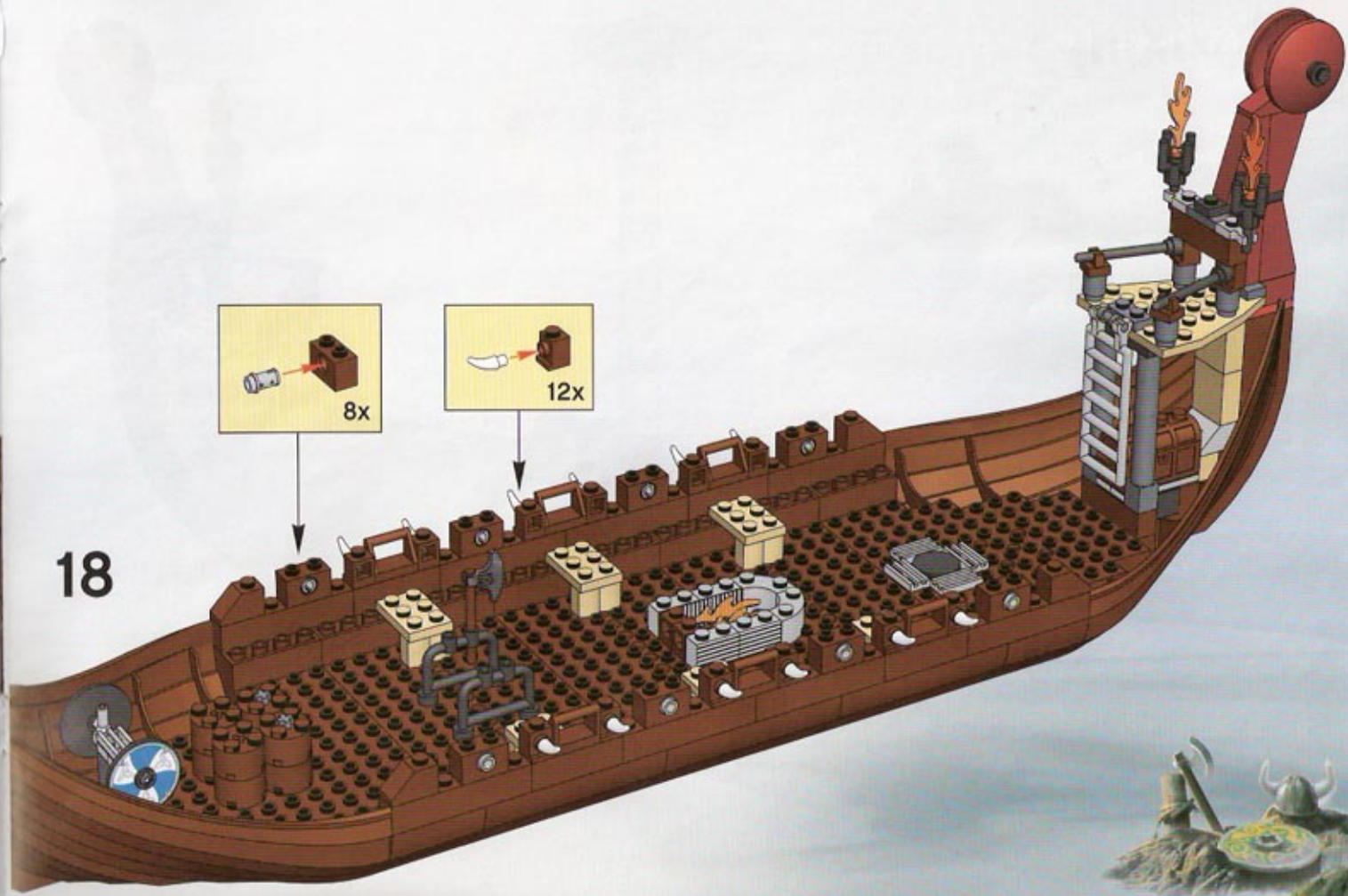
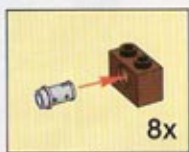

19



20

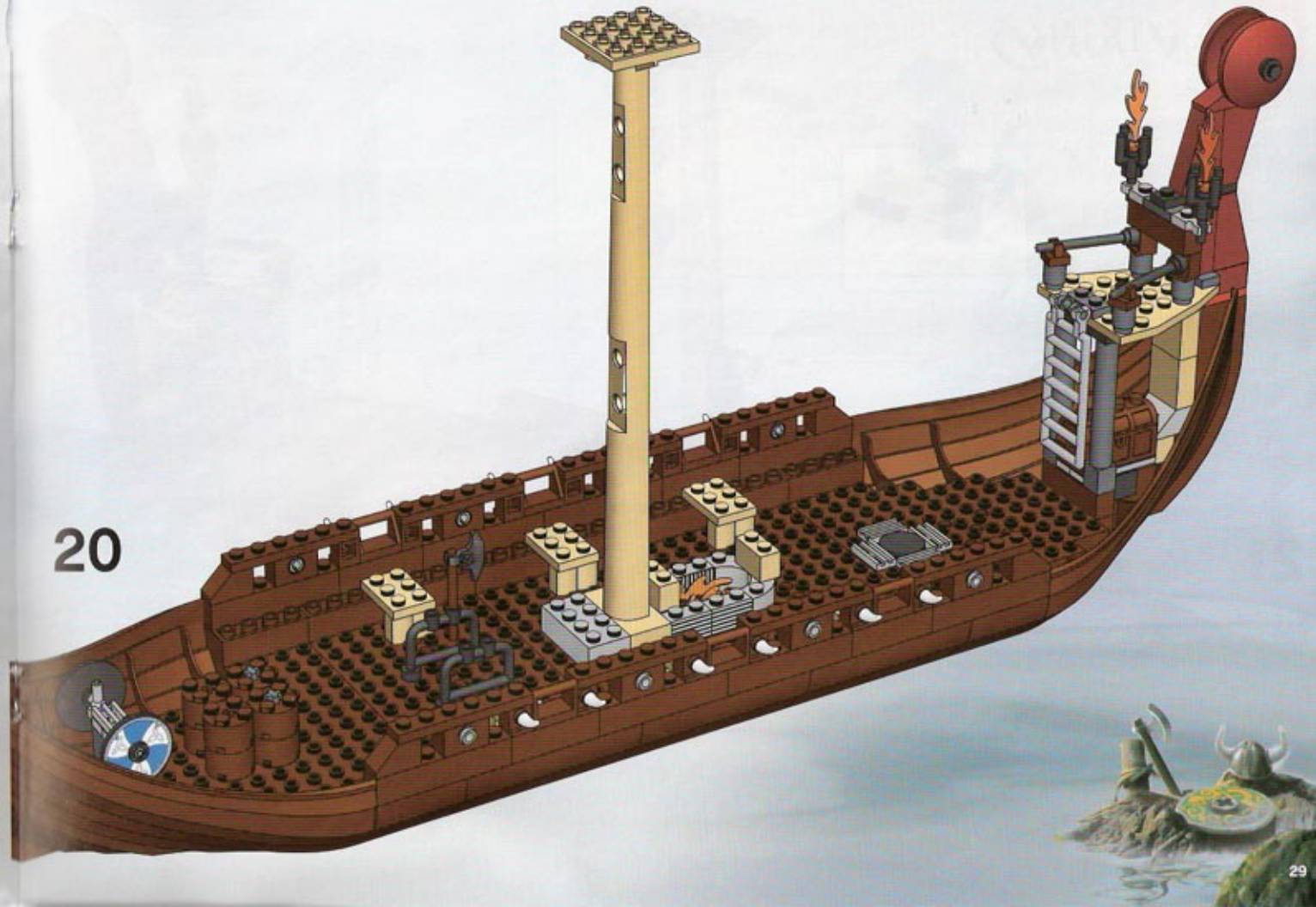

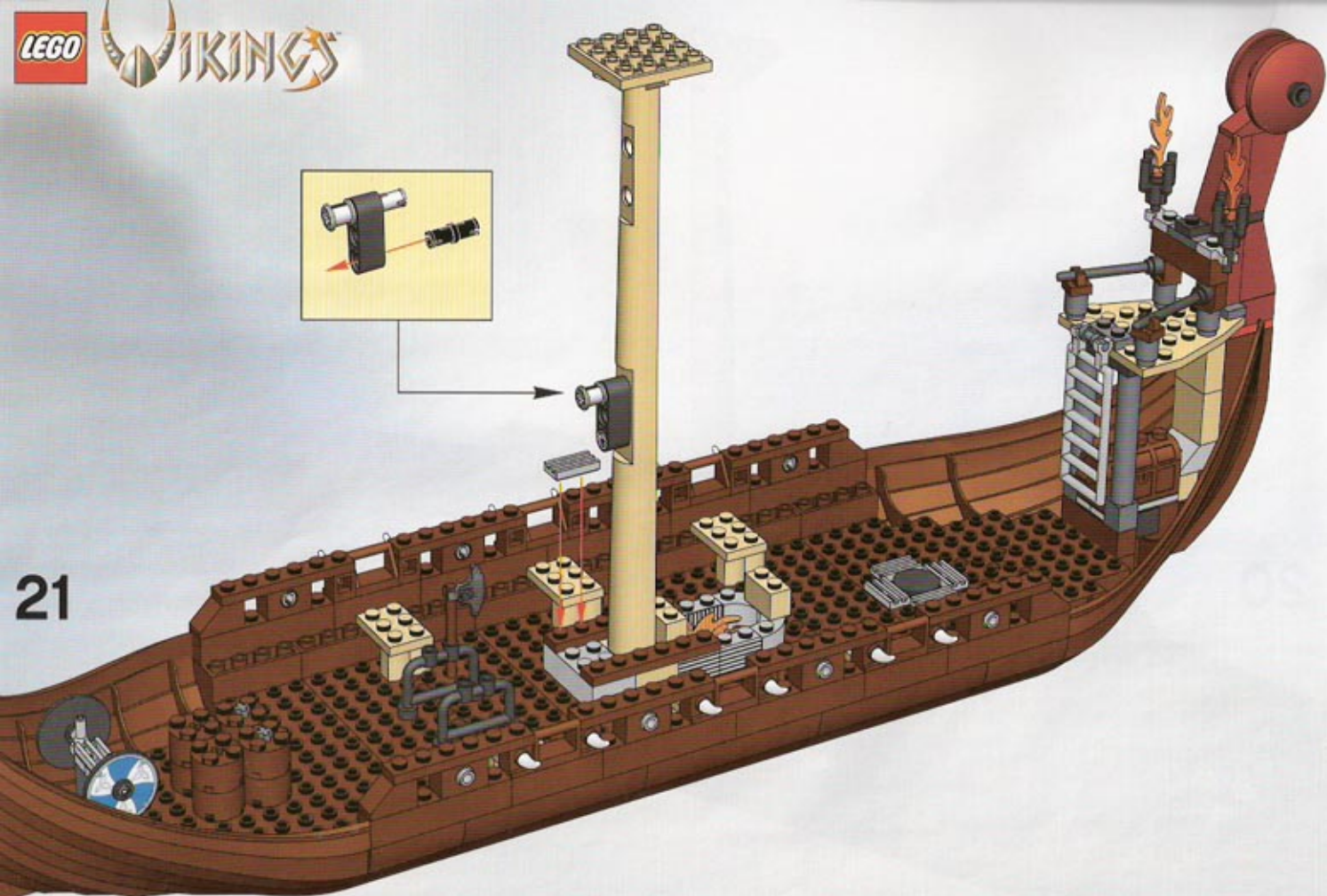

22

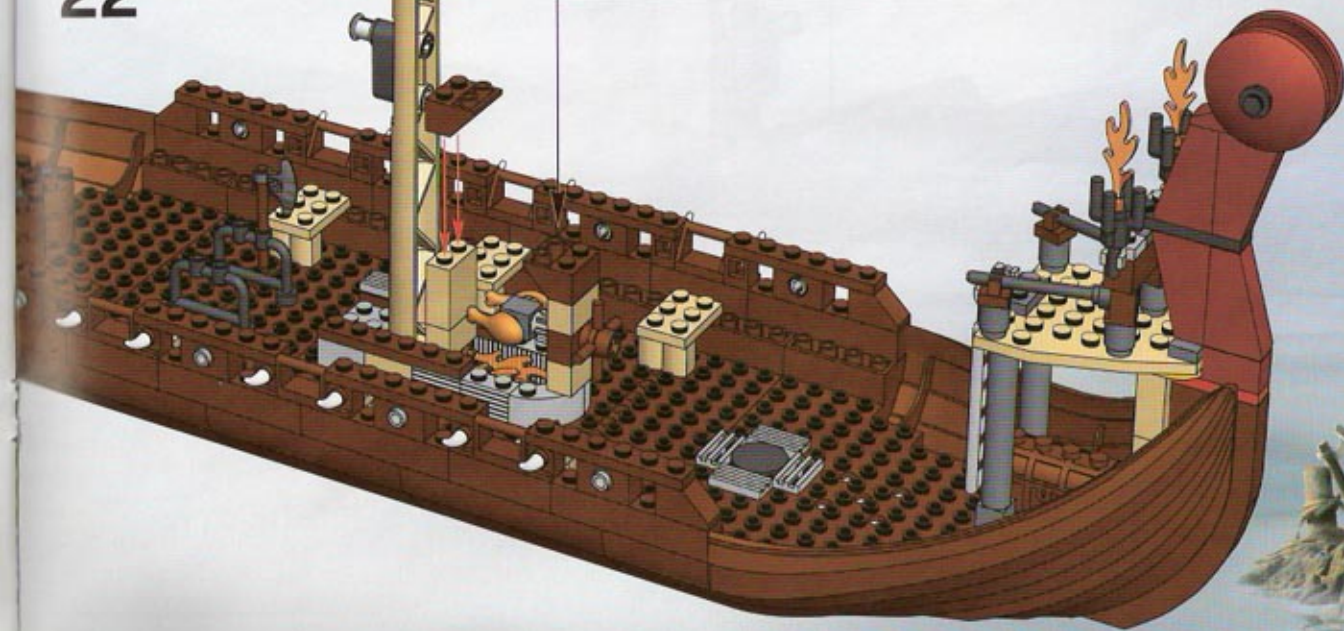
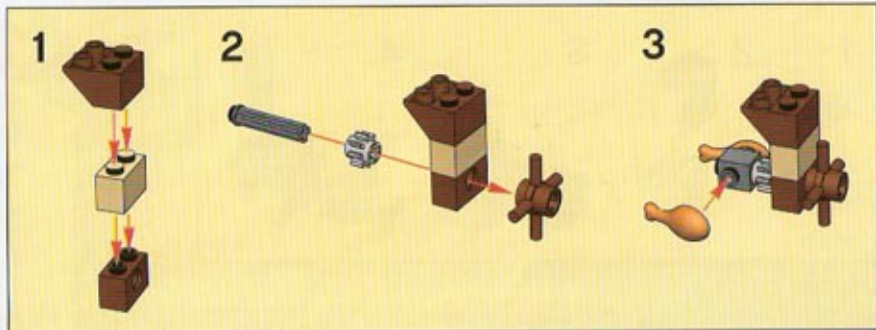

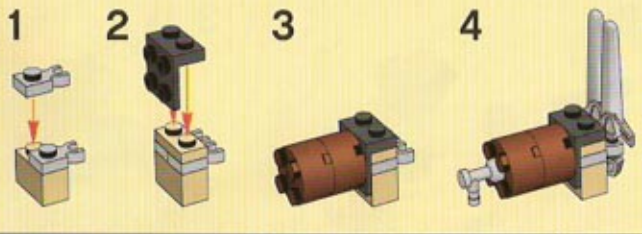

23

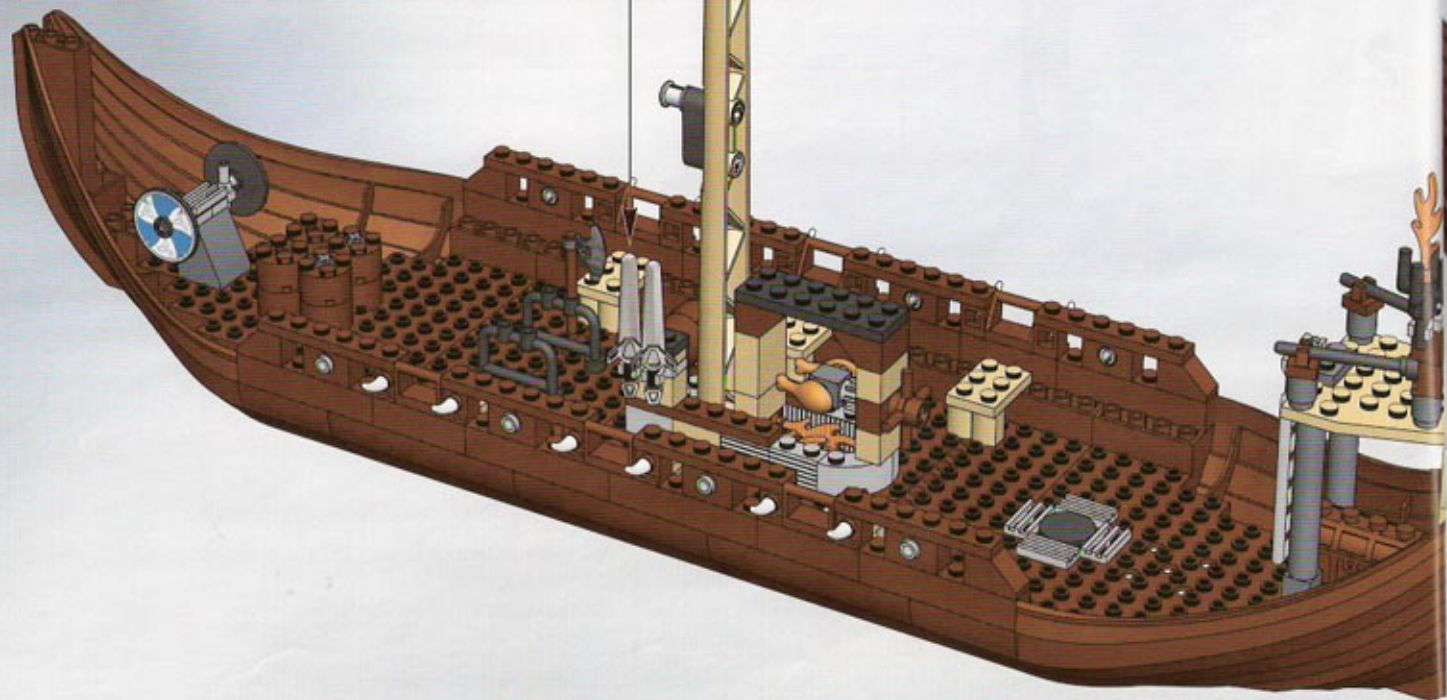

24

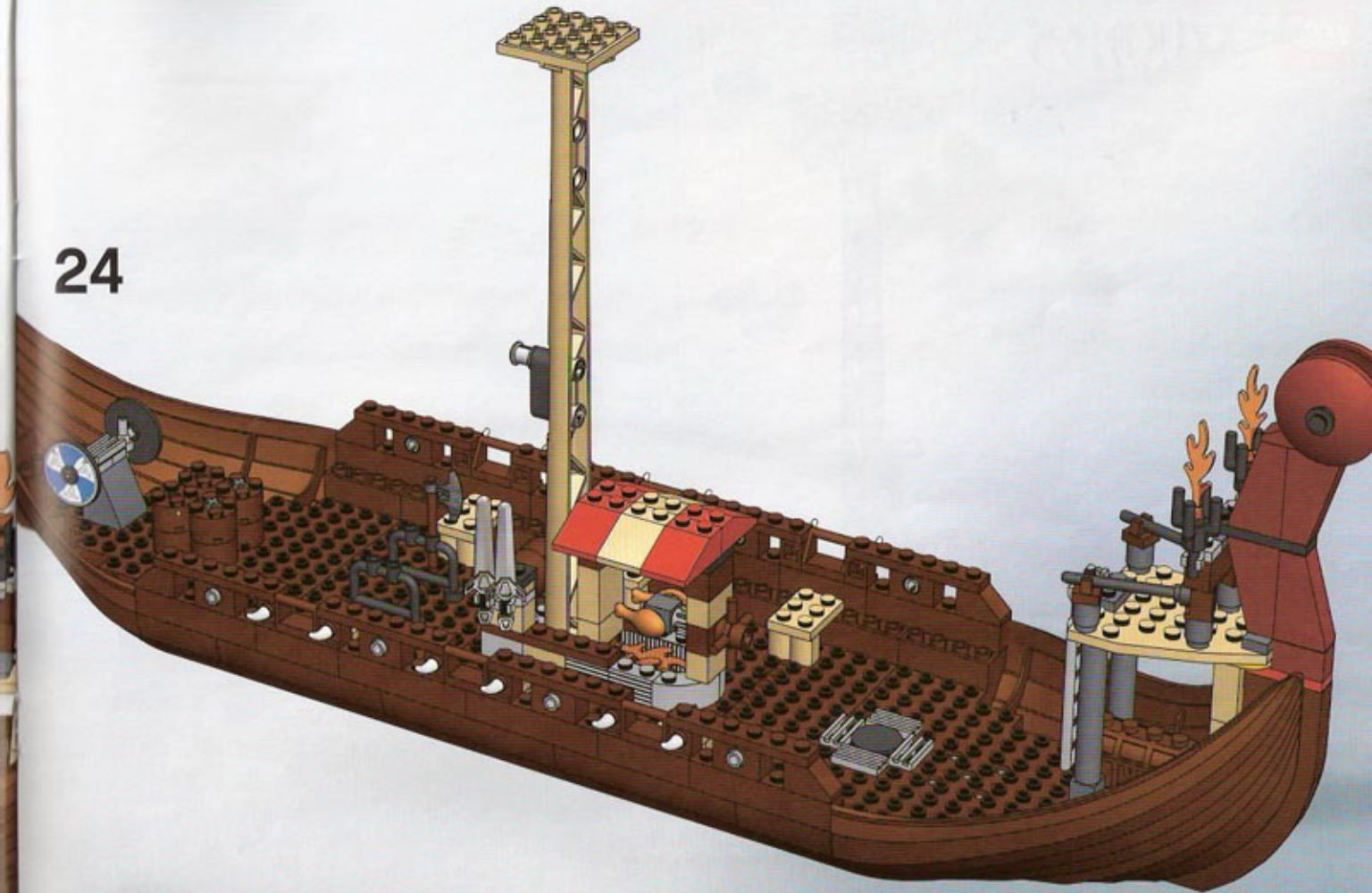

25

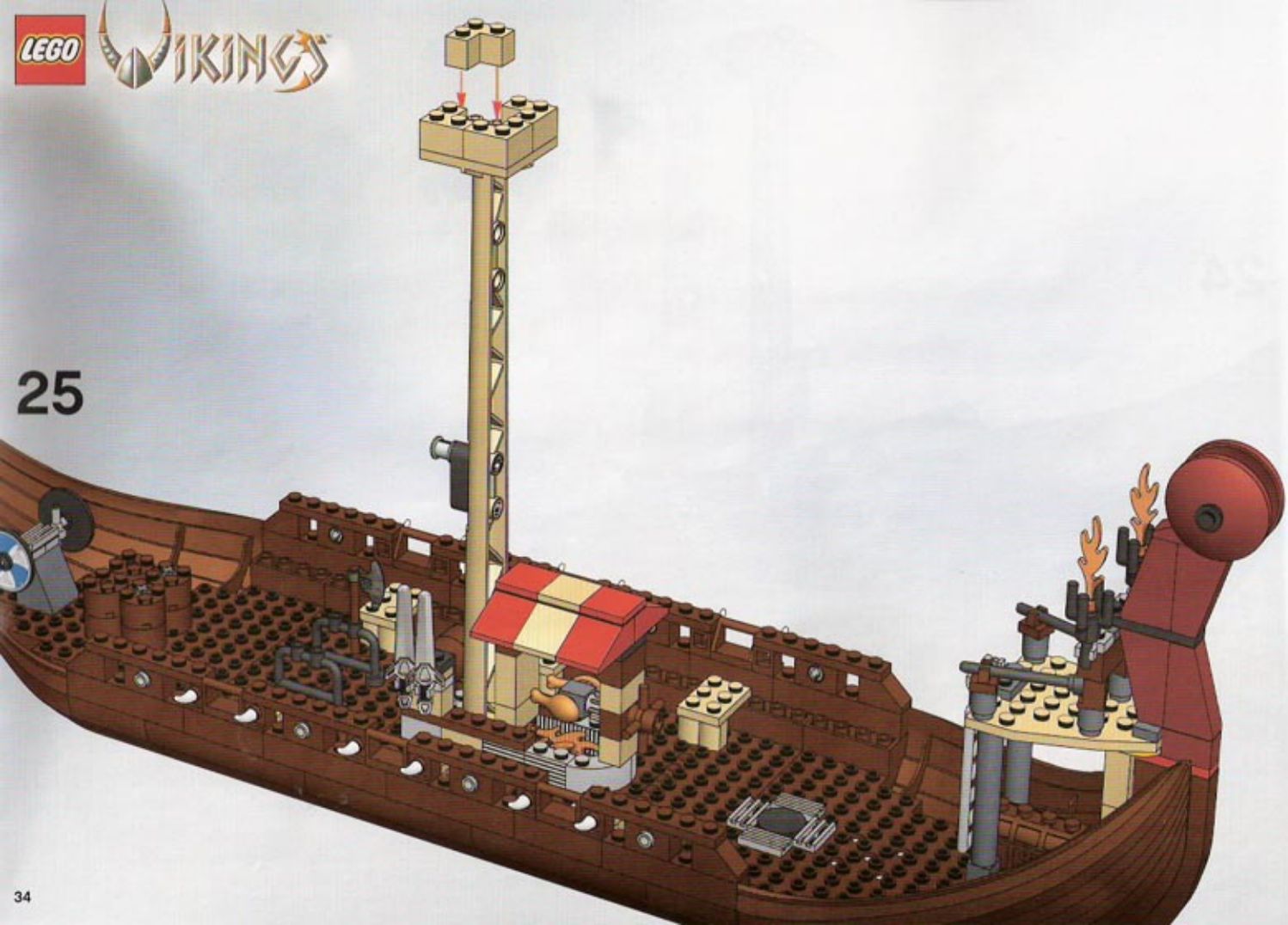

26

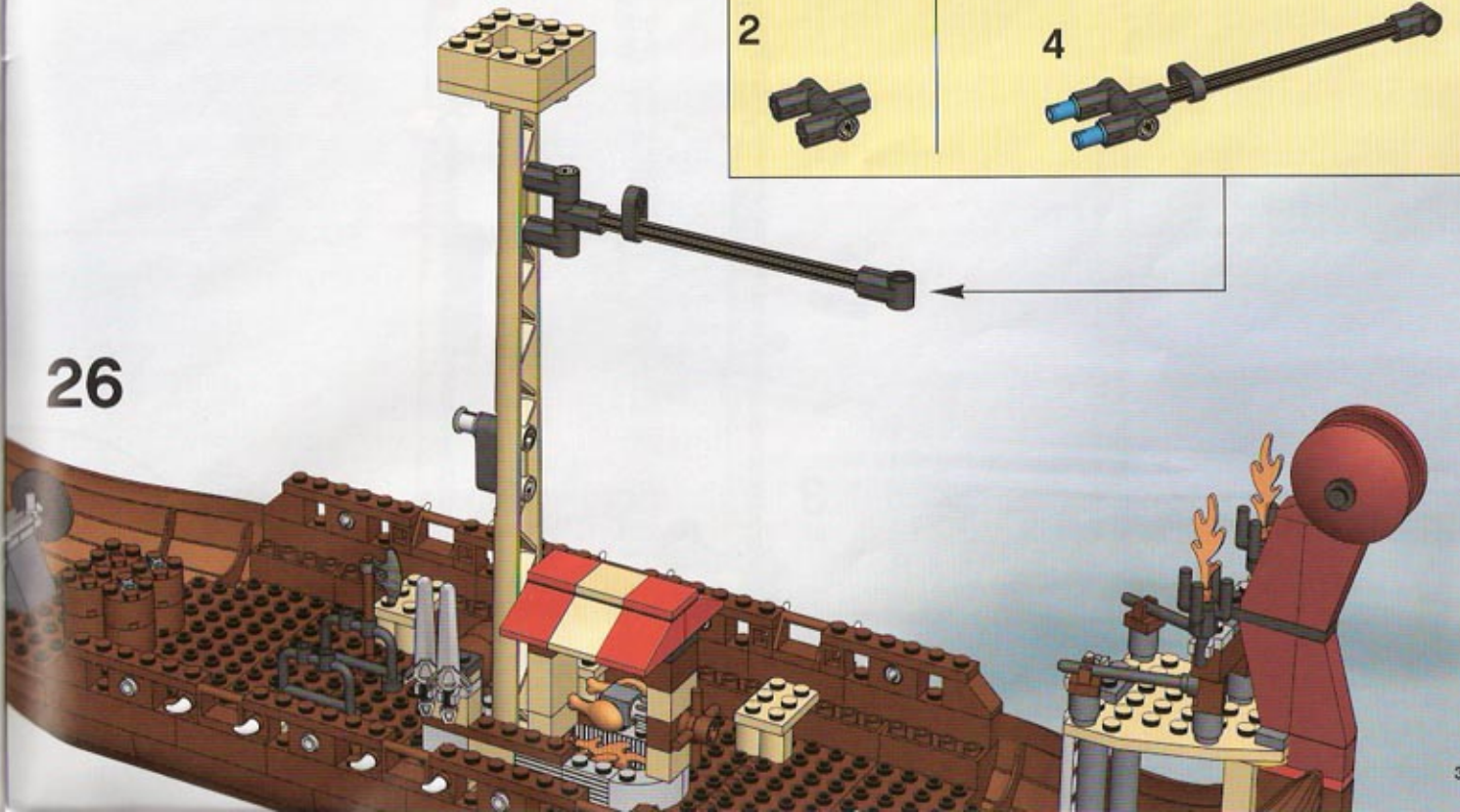
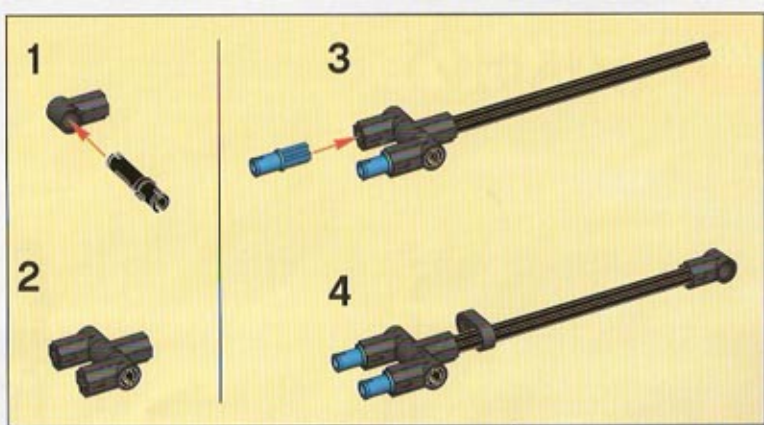

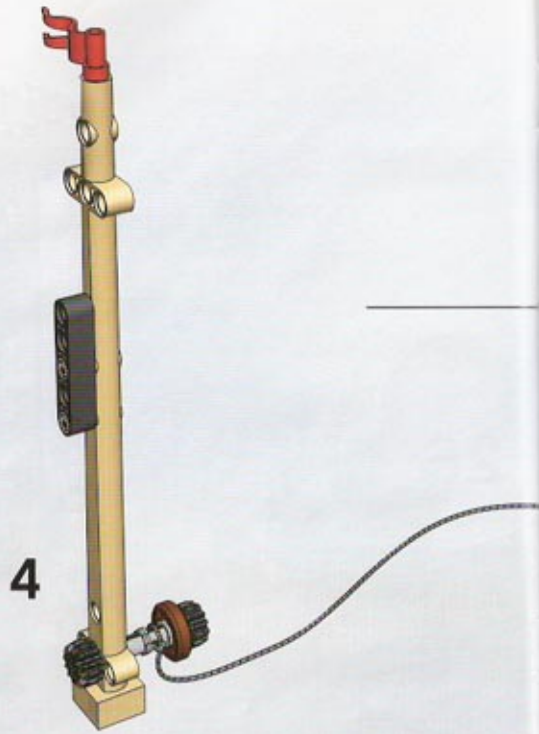
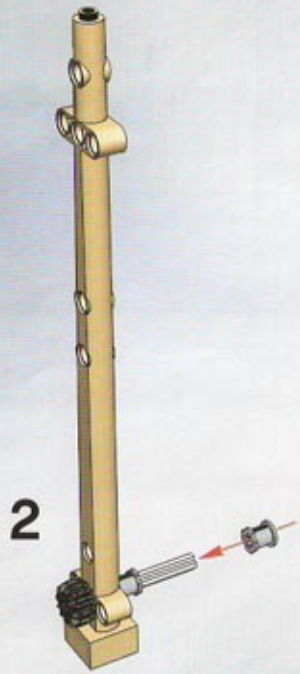
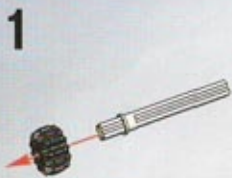

27



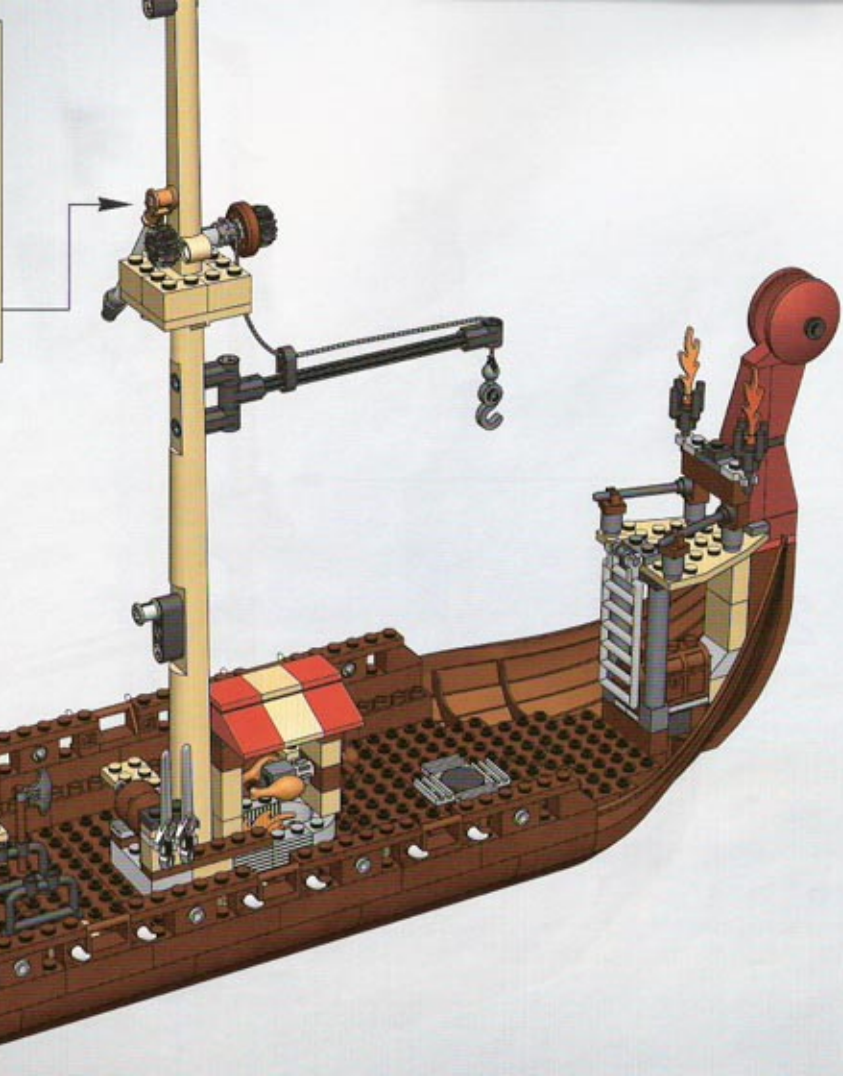
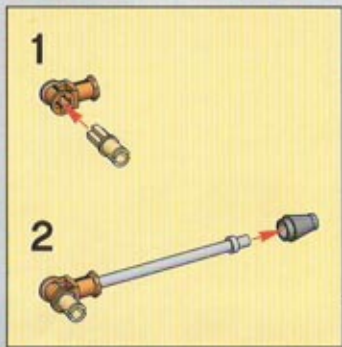

1



2

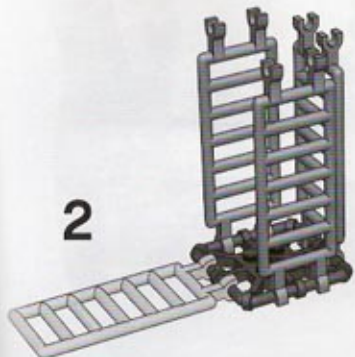

3

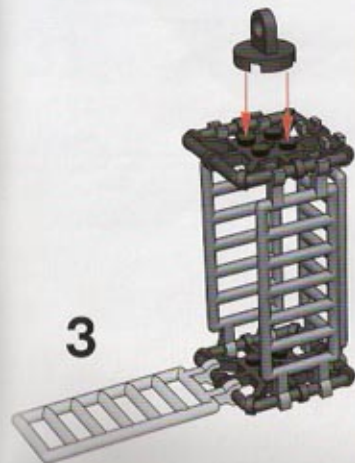

4

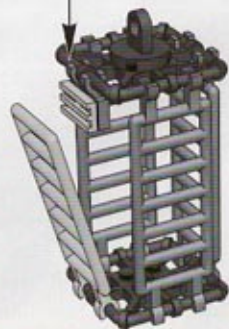
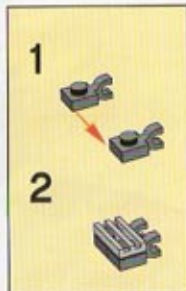

29

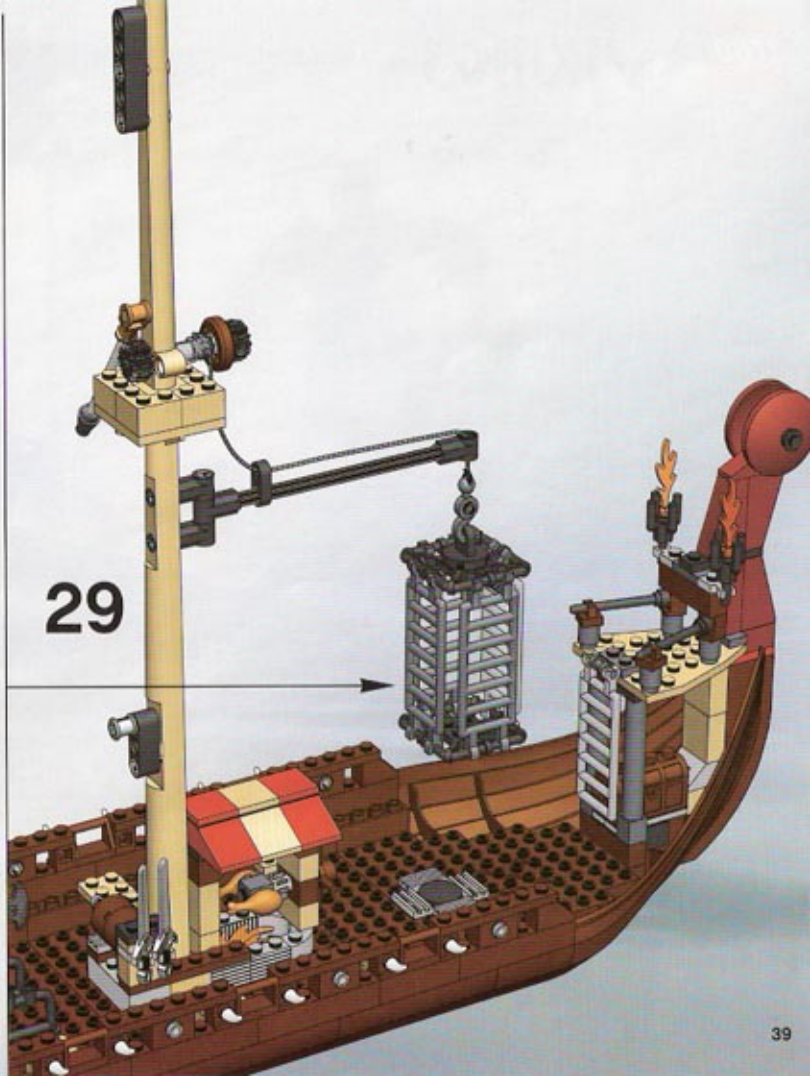

30

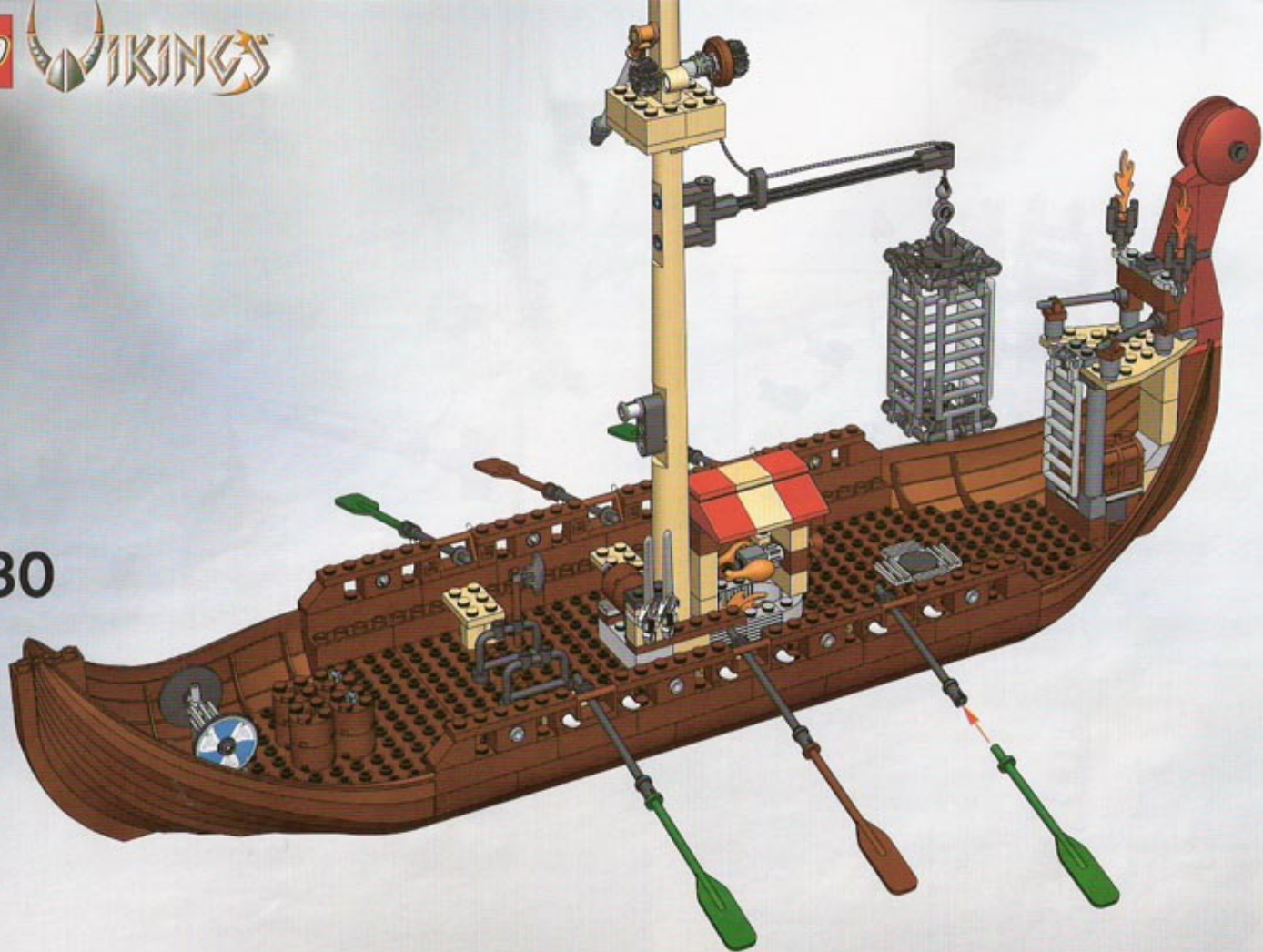

31



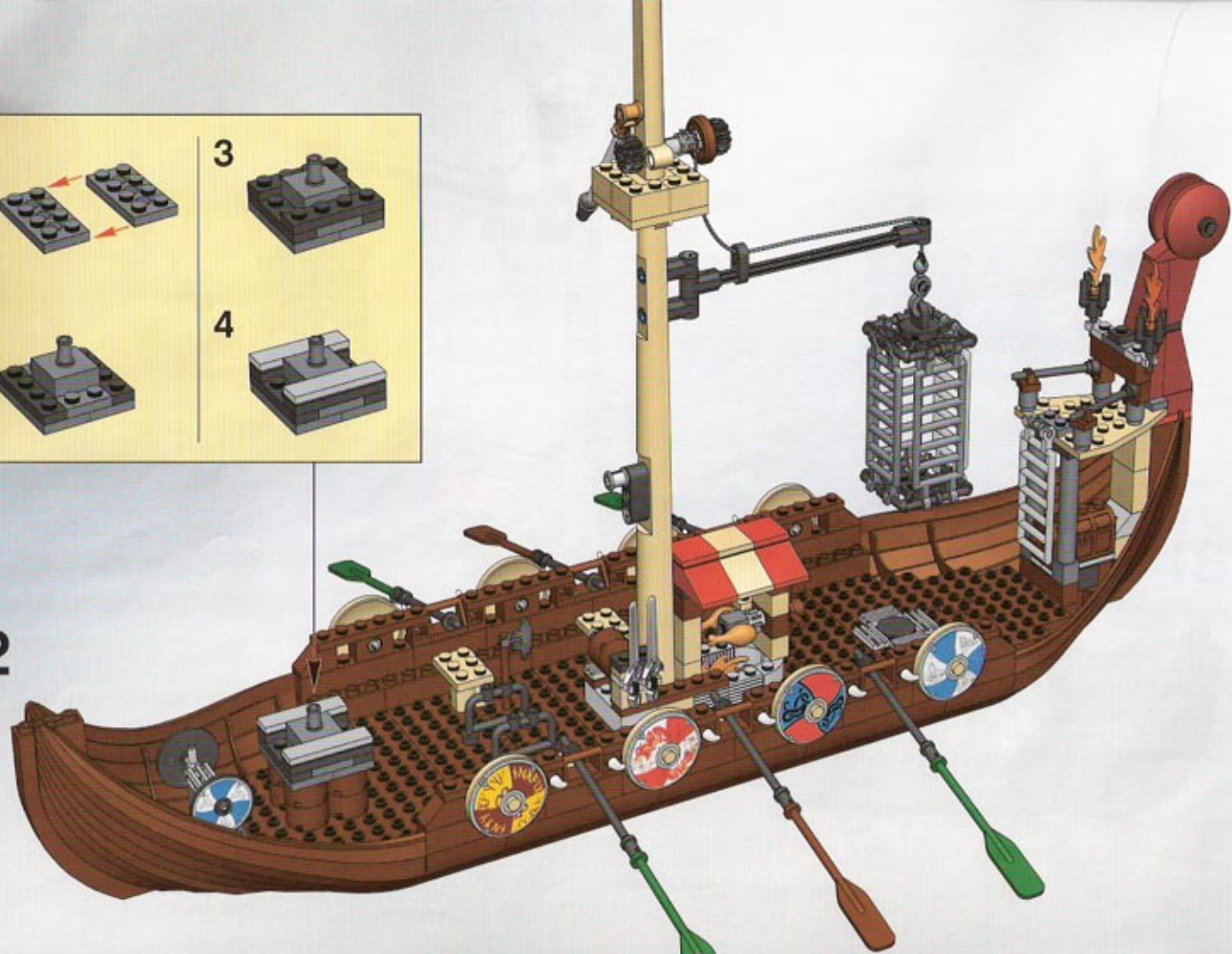
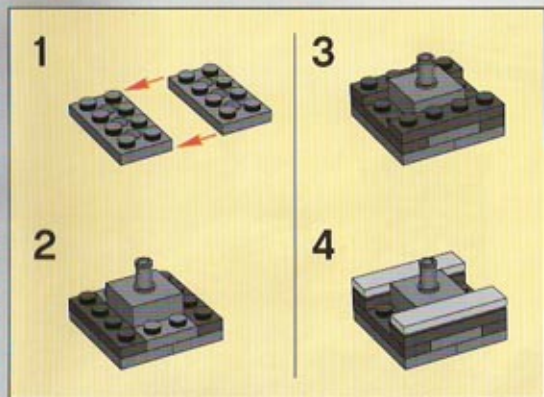

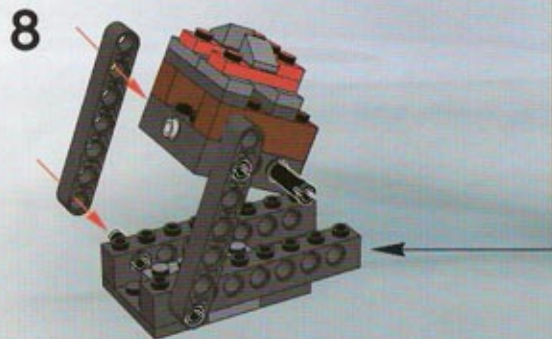
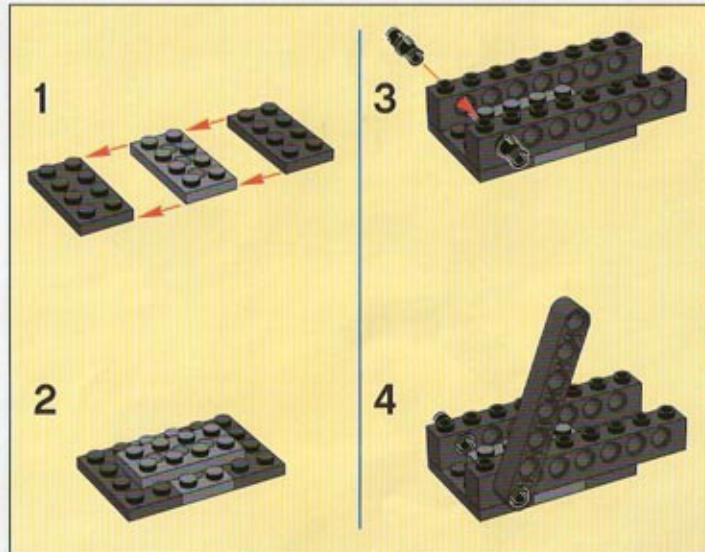
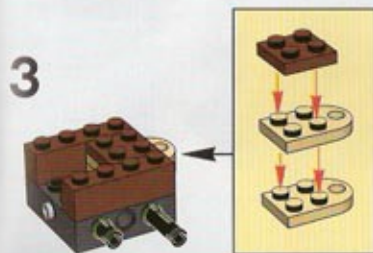
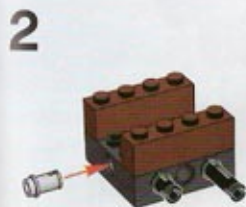

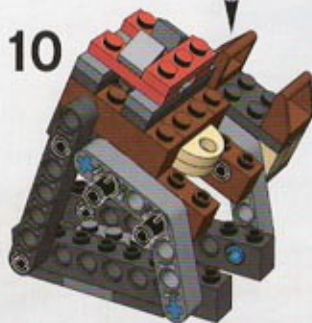
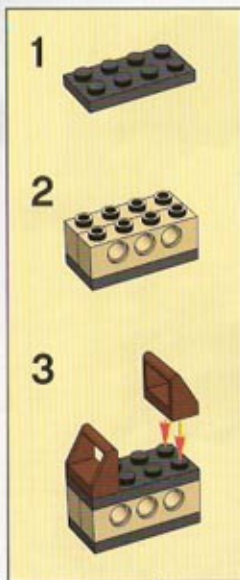
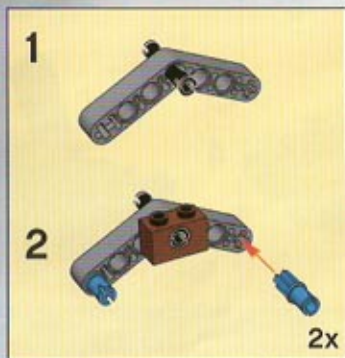



12

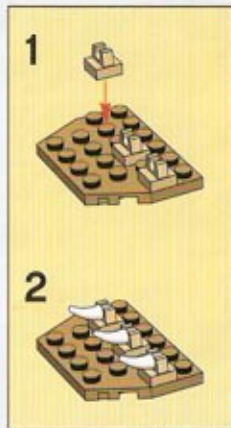
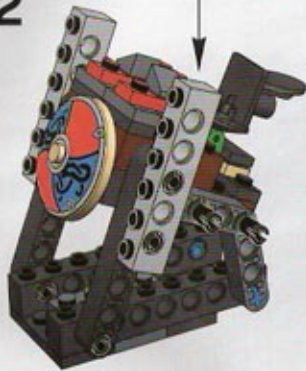

2

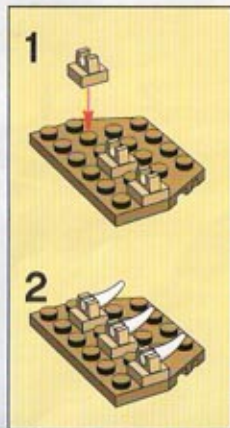

2



13

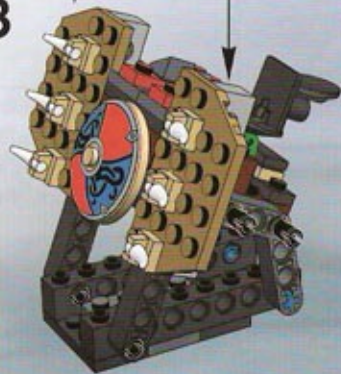

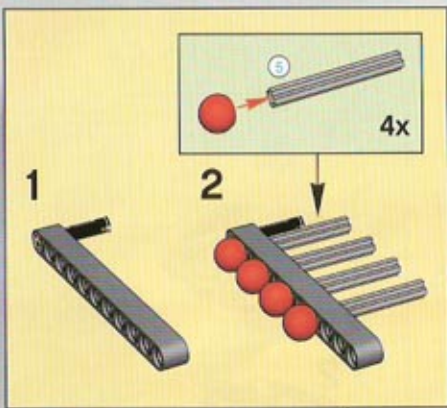

14

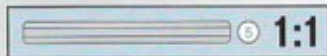
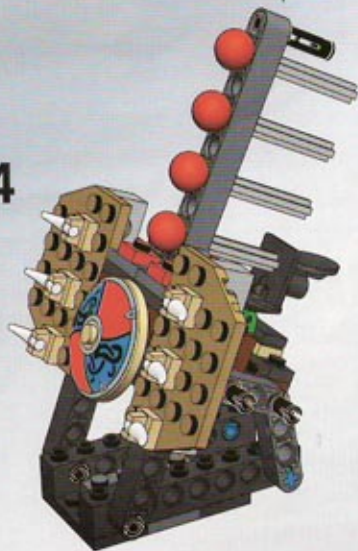

33

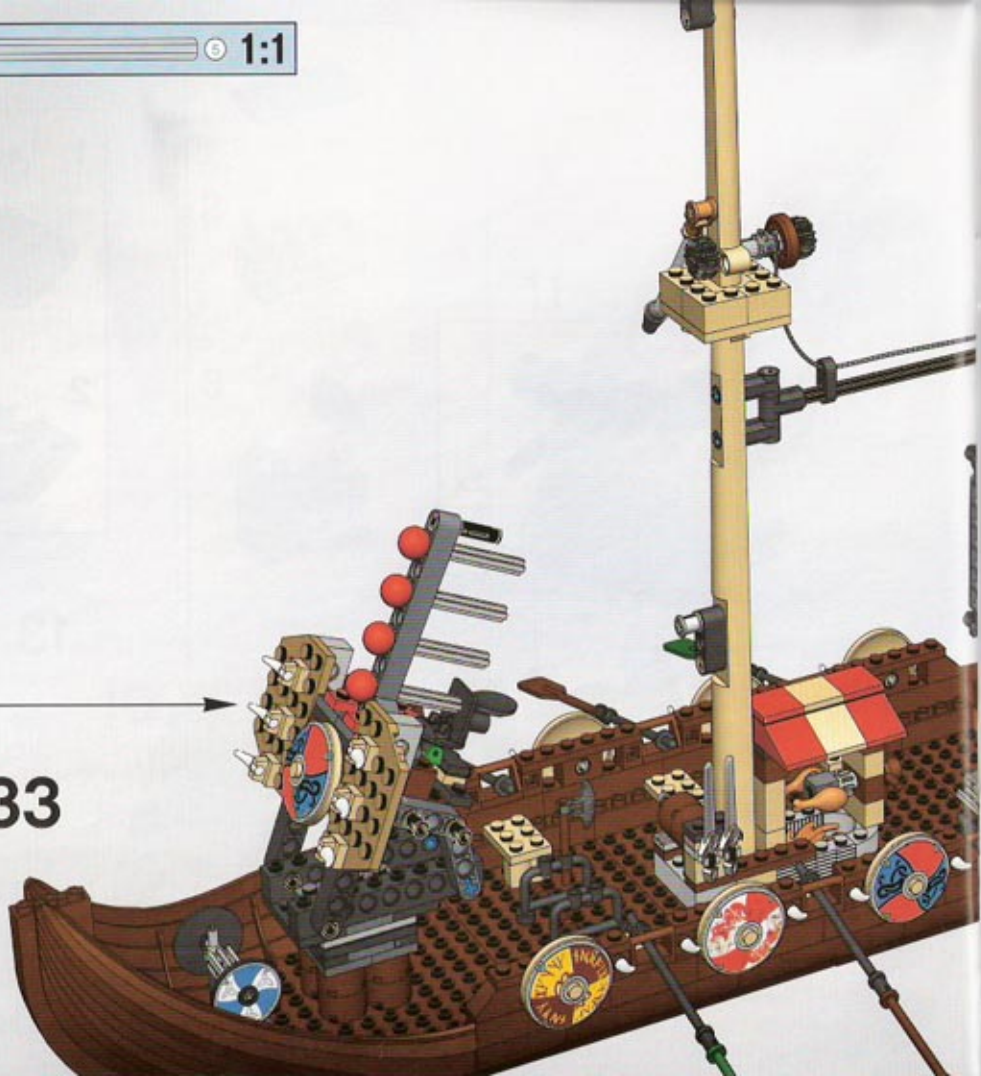

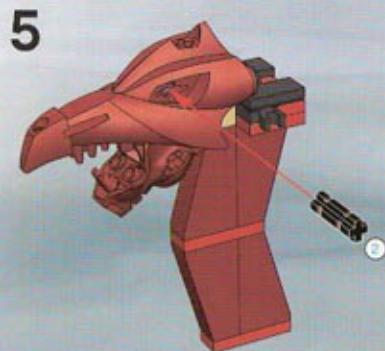
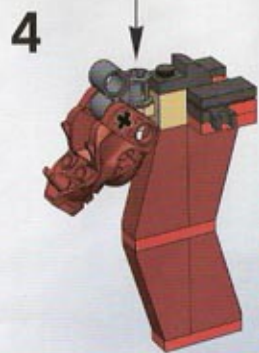

6

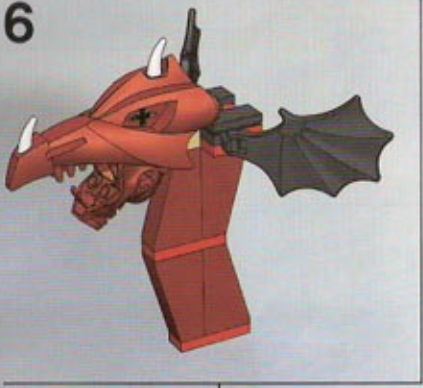

34





35

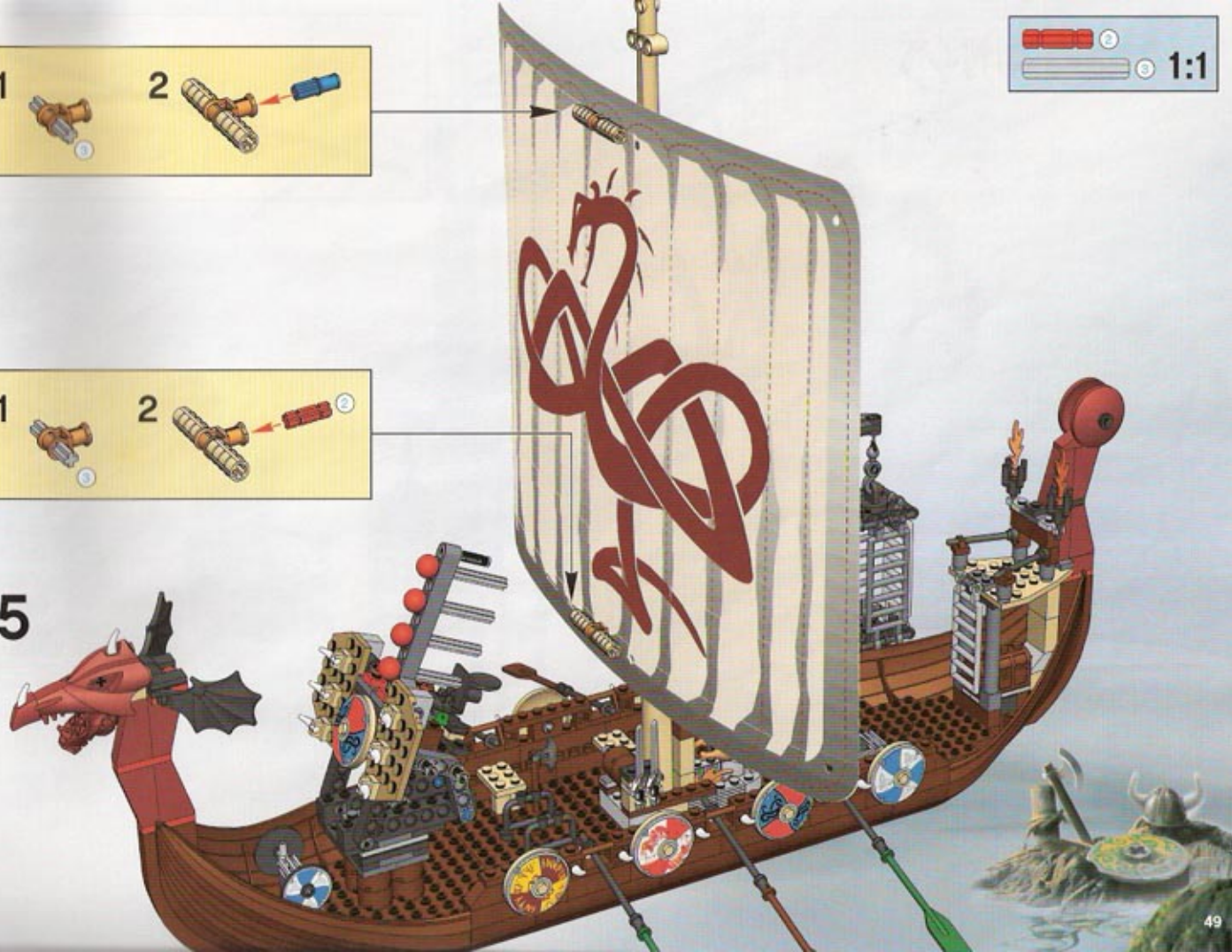

36

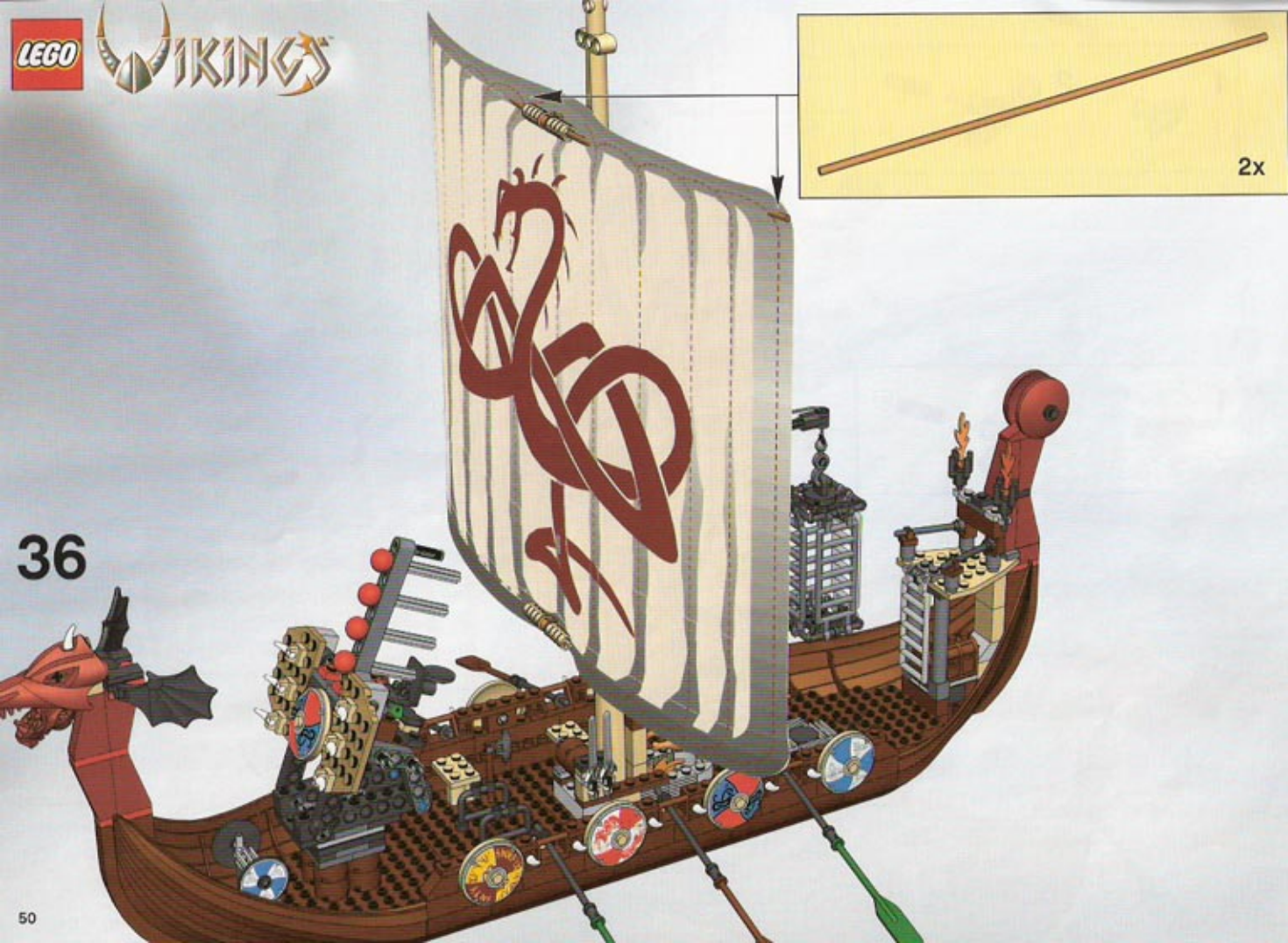

2x

37

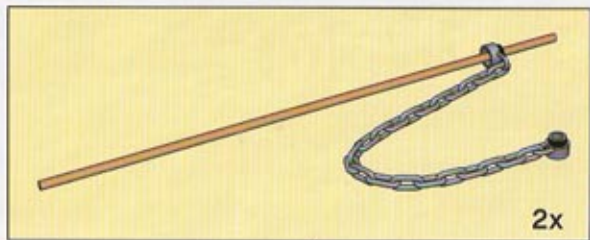
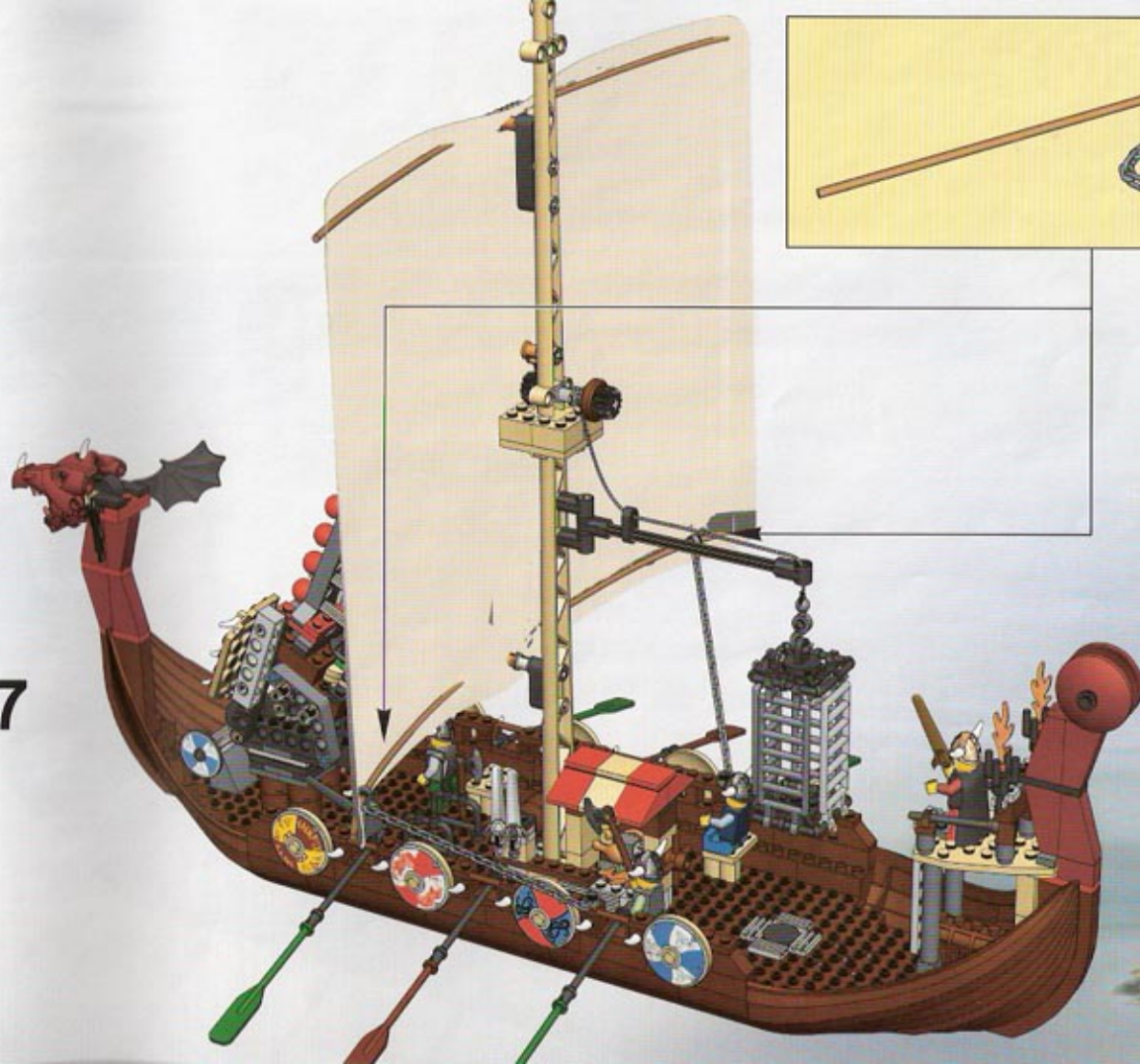

2x

38

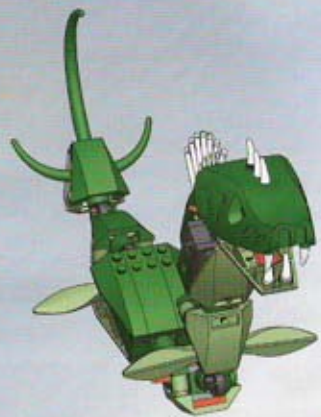

1

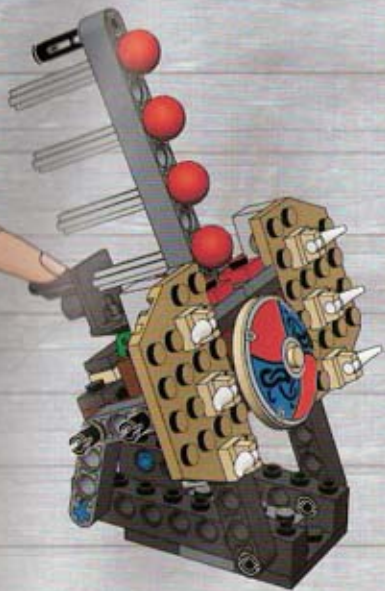

2

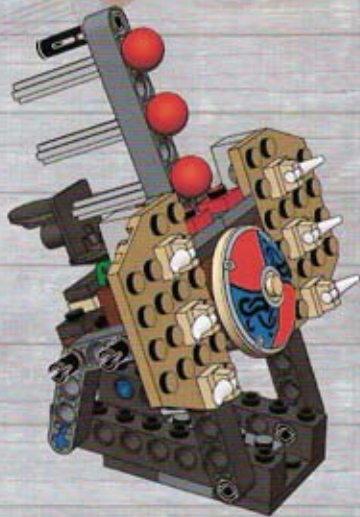



Win! Gagne! Gewinne! 当たります

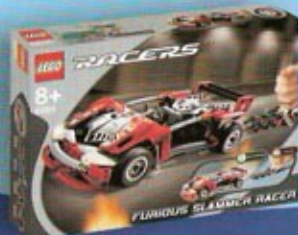

WIN LEGO® PRODUCTS

We would like to know what you think about your new LEGO® product. If you could help us by answering a few questions you are in with a chance of winning an exciting LEGO prize. It will only take you about 3 minutes! Log on to the web address below for further instructions. We would really like to hear what you think about your new LEGO product. If you'd like to help us, go to the web address below for further instructions.



Estimado usuario LEGO®

Al contestar algunas preguntas en inglés, francés, alemán o japonés, en el sitio www.acnielsen.aim.dk/lego, podrás participar en el sorteo de algunos valiosos premios LEGO®.



抽選でレゴ®製品が当たります

私たちは、皆さんが新しいおもちゃの製品についてどんな感想をお持ちか、知りたいと思っています。質問に答えて、楽しいレゴ®製品の抽選に応募していただく。アンケートの回答には、ほんの少しの時間がかかります。詳しくは、以下のウェブアドレスから見てください。



GAGNE DES PRODUITS LEGO®

Nous aimerions savoir ce que tu penses de ton nouveau produit LEGO®. Si tu veux bien nous aider en répondant à quelques questions, tu recevras peut-être bientôt un fantastique prix LEGO. Et cela ne te prendra que 3 minutes environ ! Tu obtiendras davantage d'informations en visitant le site internet indiqué ci-dessous. Nous aimerions savoir ce que tu penses de ton nouveau produit LEGO. Si tu souhaites nous aider, rends-toi à l'adresse Internet ci-dessous où tu trouveras des instructions supplémentaires.



Caro Consumidor da LEGO®

Ao responder à algumas perguntas em inglês, francês, alemão ou japonês no endereço www.acnielsen.aim.dk/lego irá participar num concurso para ganhar valiosos prémios da LEGO®.



GEWINNE LEGO® PRODUKTE

Wir sind sehr an deiner Meinung über dein neues LEGO® Produkt interessiert. Wenn du uns den Gefallen tust und ein paar Fragen beantwortest, kannst du einen tollen LEGO Preis gewinnen. Das Ganze dauert nur etwa 3 Minuten! Gehe einfach zu der unten angegebenen Webadresse – dort findest du weitere Informationen. Wir möchten gerne wissen, was Sie von Ihrem neuen LEGO Produkt halten. Wenn Sie uns helfen möchten, besuchen Sie bitte die u.a. Website, auf der Sie alles Weitere erfahren.



Kedves Új LEGO® Vásárló!

Ha elátogatasz a www.acnielsen.aim.dk/lego honlapra és ott angol, francia, német vagy japán nyelven megválaszolod néhány kérdést, akkor részt vehetsz egy versenyben, amelyben értékes LEGO® díjakat nyerhetsz.

www.acnielsen.aim.dk/LEGO



Discover the LEGO® UNIVERSE!



www.LEGOuniverse.com

LEGO SHOP at HOME

The
World's
Biggest
LEGO
Shop!

English Deutsch Français



LEGO club



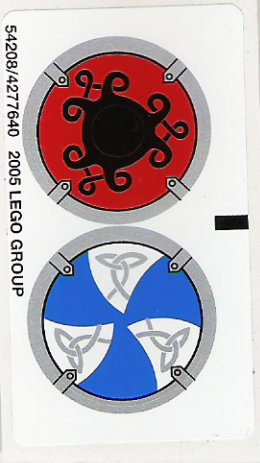

54208/4277640 2005 LEGO GROUP

6 7 8 9 10 11 12 13 14 15 16 17 18 19 20 21 22 23 24



© 2001 The LEGO Group