

LEGO

CITY

7245



4266175



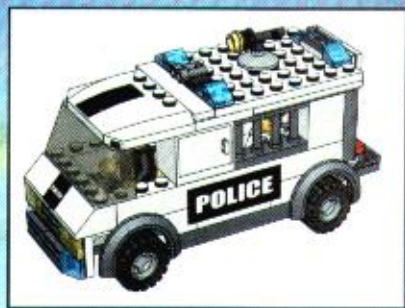

1

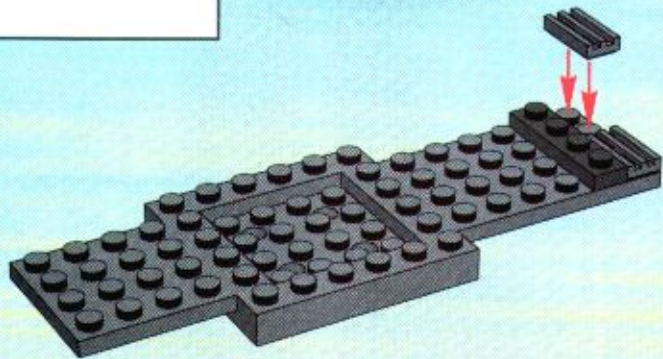

2

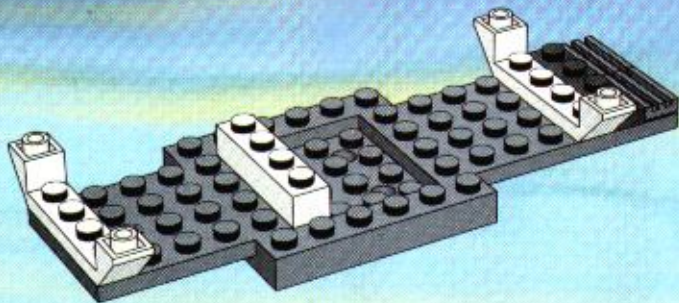

3

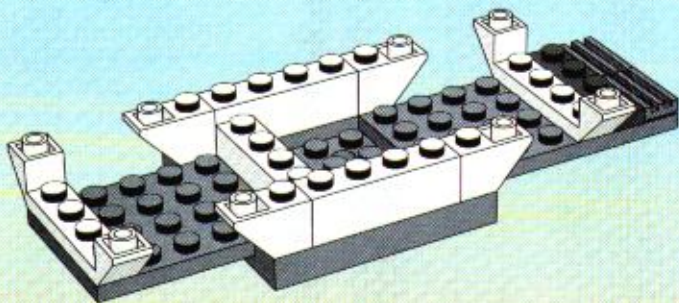

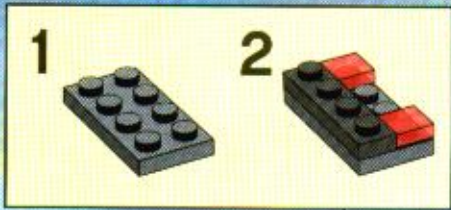

4

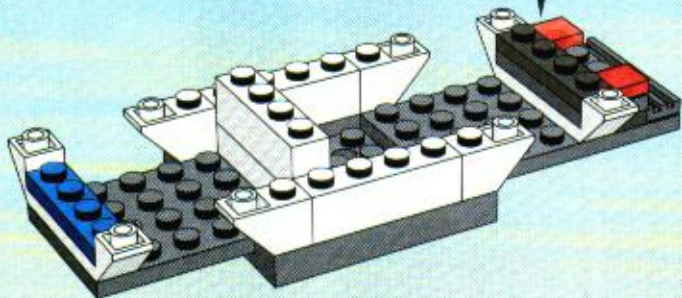

5

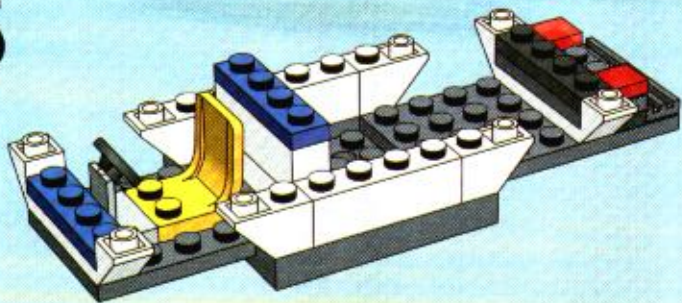

6

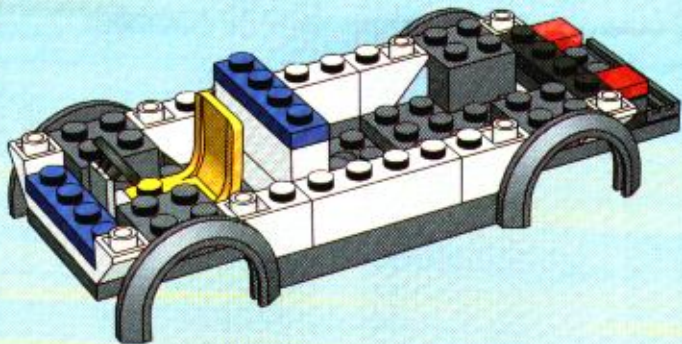

7

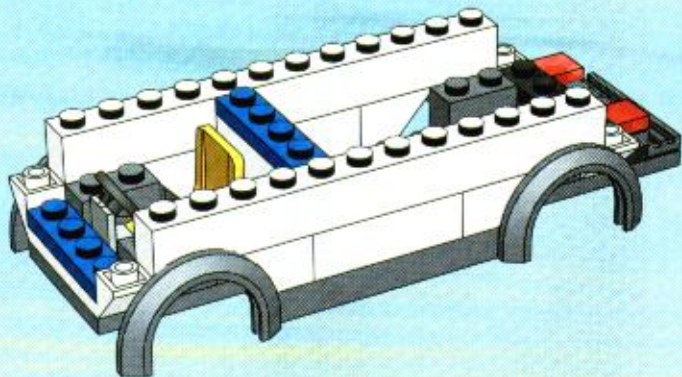

8

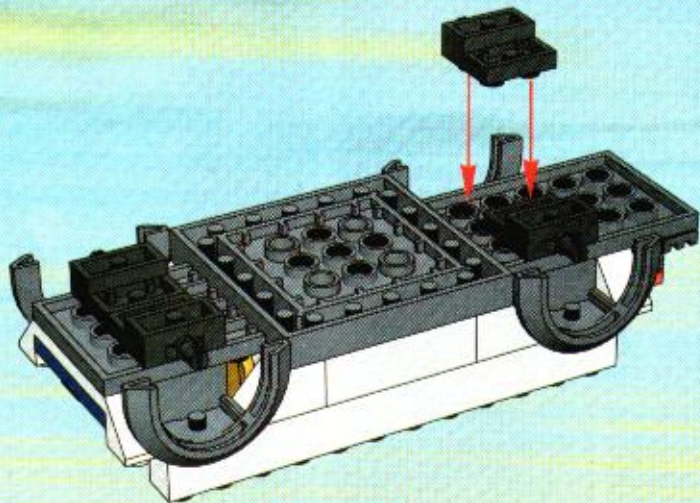

9

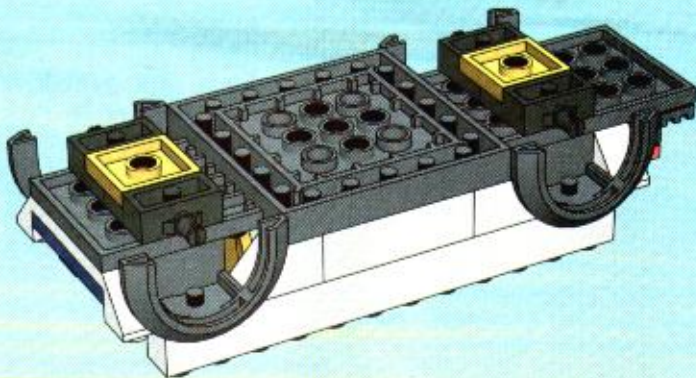

10

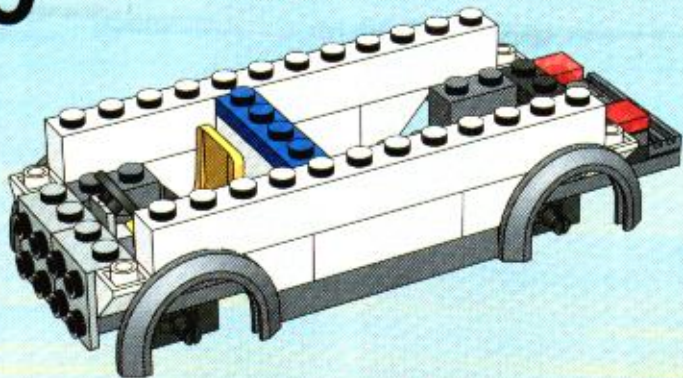

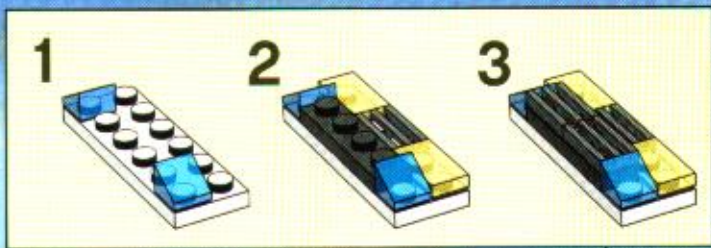

11

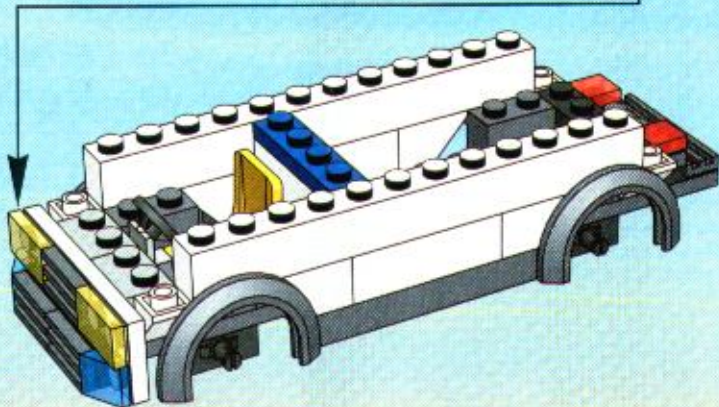

12

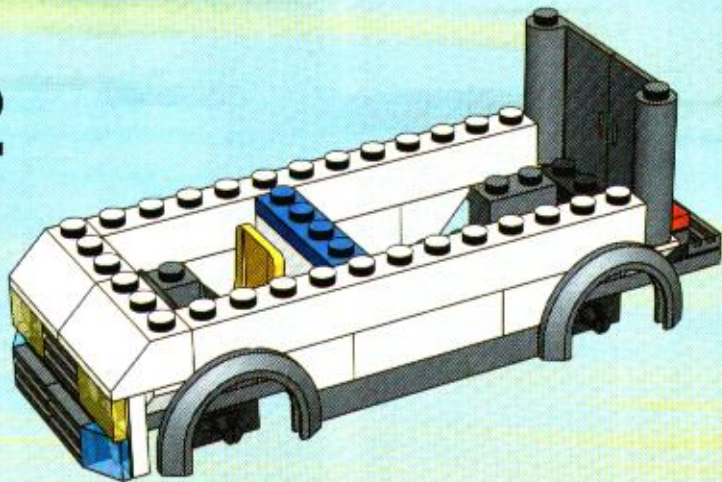

13

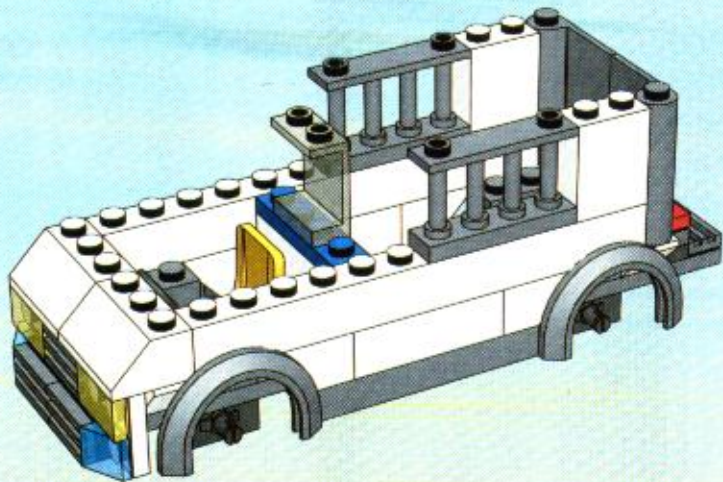

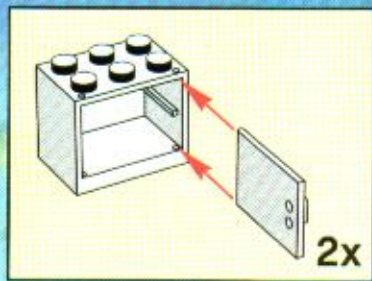

14

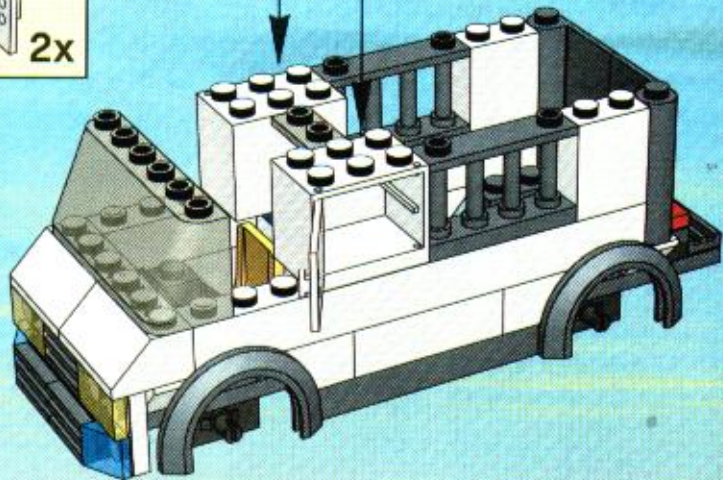

15

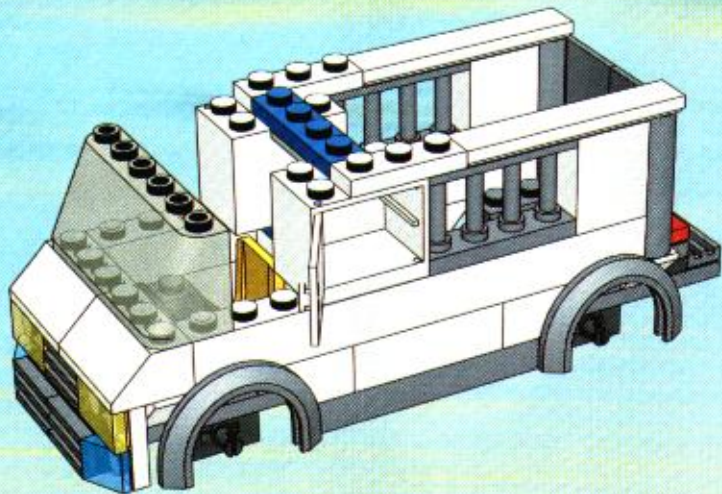

16

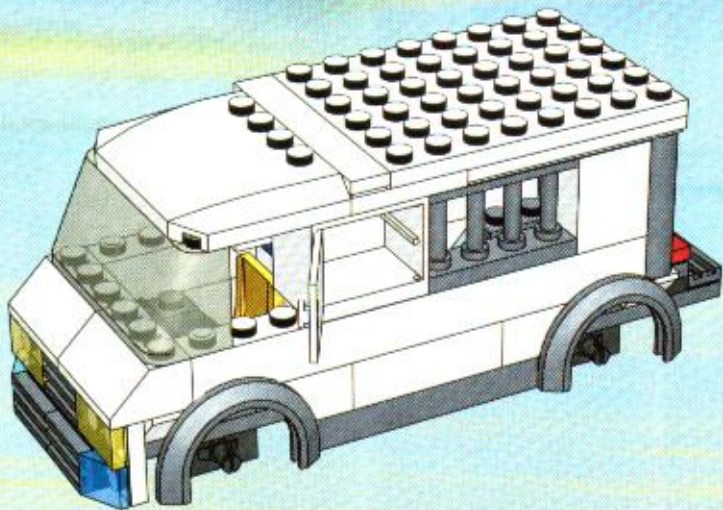

1

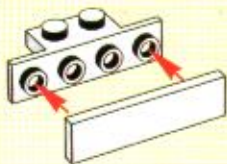

2



17

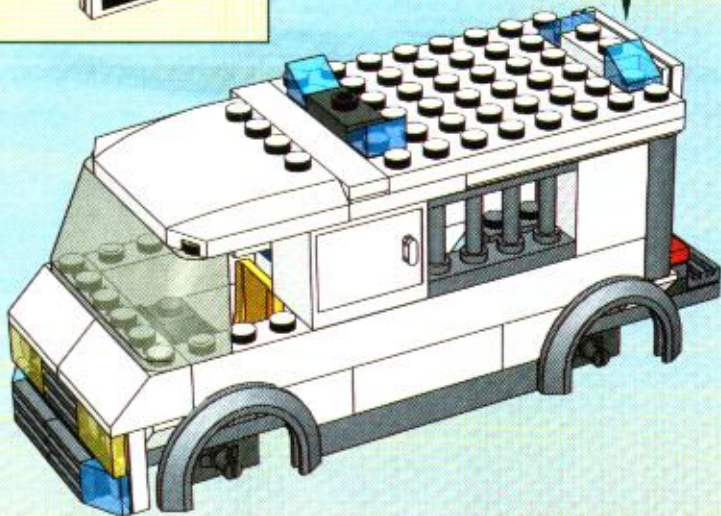

18

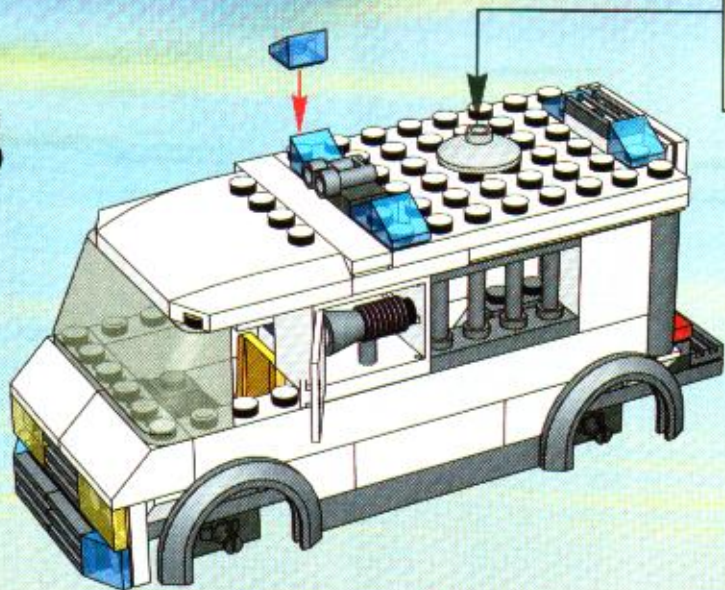

19







7237



7235



7236



7245



7238



7246



7240



7239



7241

Win! Gagne! Gewinne! 当たります



WIN LEGO® PRODUCTS

We would like to know what you think about our new LEGO® product. Log on to the web address below for further instructions.

GAGNE DES PRODUITS LEGO®

Nous aimerions savoir ce que tu penses de ton nouveau produit LEGO®. Tu obtiendras davantage d'informations en visitant le site Internet indiqué ci-dessous.

GEWINNE LEGO® PRODUKTE

Wir sind sehr an deiner Meinung über dein neues LEGO® Produkt interessiert. Gehe einfach zu der unten angegebenen Webadresse - dort findest du weitere Informationen.

抽選でレゴ®製品が当たります

詳しくは、以下のURLアドレスまでアクセスして下さい。

ESTIMADO USUARIO LEGO®

Al contestar algunas preguntas en inglés, francés, alemán o japonés en el sitio www.acnielsen.aim.dk/lego podrás participar en el sorteo de algunos valiosos premios LEGO®.

CARO CONSUMIDOR DA LEGO®

Ao responder a algumas perguntas em Inglês, Francês, Alemão ou Japonês no endereço www.acnielsen.aim.dk/lego irá participar num concurso para ganhar valiosos prémios da LEGO®.

KEDVES IFJÚ LEGO® VÁSÁRLÓ

Ha eliaogat az www.acnielsen.aim.dk/lego honlapra és ott angol, francia, német vagy japán nyelven megválaszolsz néhány kérdést, akkor részt veszel egy versenyben, amelyben értékes LEGO® ajándék nyerhetsz.

www.acnielsen.aim.dk/LEGO

LEGO®, the LEGO logo, the CLICIT logo and Technic are trademarks of The LEGO Group. ©2004 The LEGO Group.
Pierrel, all associated logos and the distinctive design are trademarks of Pierrel S.p.A.
The border of the banner set is protected as Patent property under Swiss design and/or design regulations.

POLICE

POLICE

POLICE

POLICE

POLIZEI

POLIZEI

POLIZEI

POLIZEI

52800/4261757 © 2005 LEGO GROUP

1

2

3

4

5

6

7

8

9

1

2

3