

**LEGO**

# KNIGHTS' KINGDOM

7+

8779

 **slammer**



**3 GAME CARDS INCLUDED**  
**3 CARTES DE JEU INCLUSES**



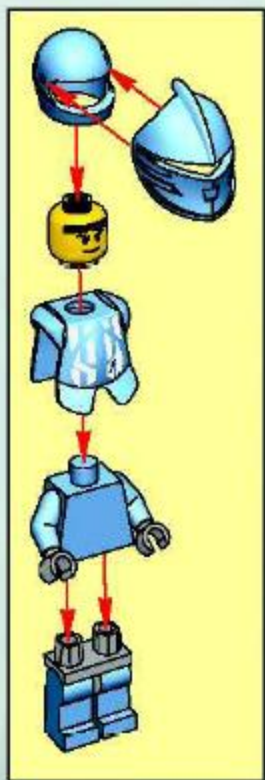

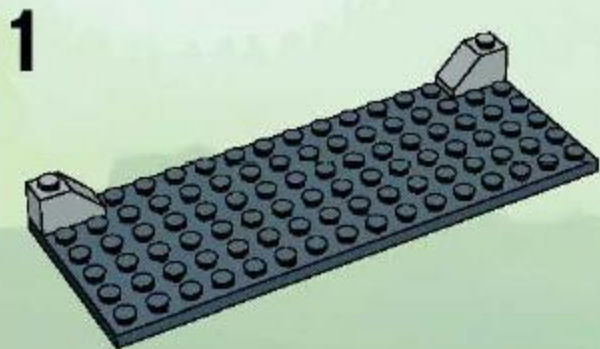

**2**

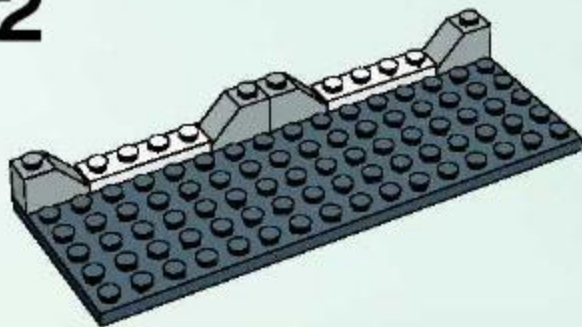

**3**

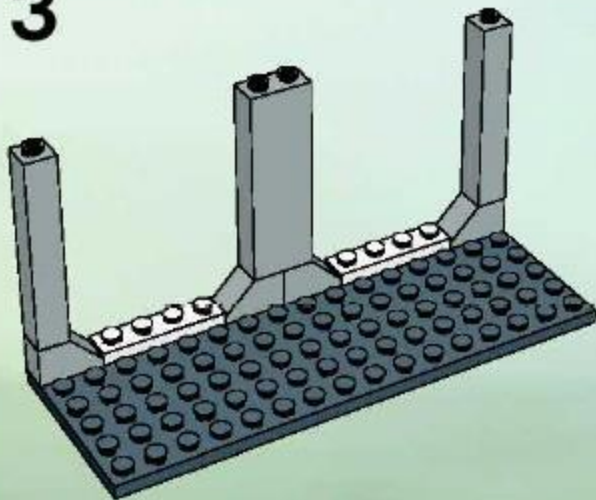

4

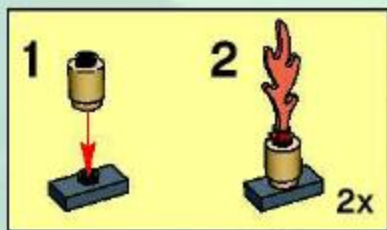
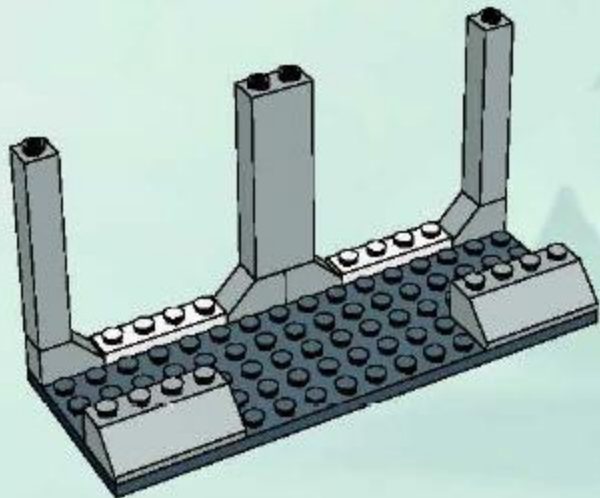

5

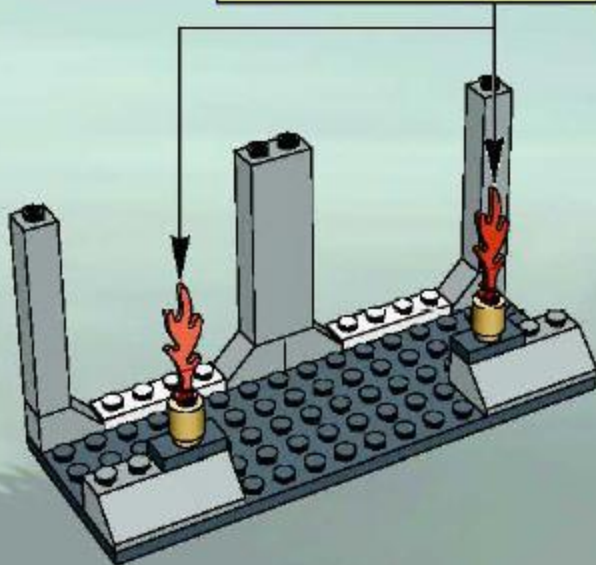

6

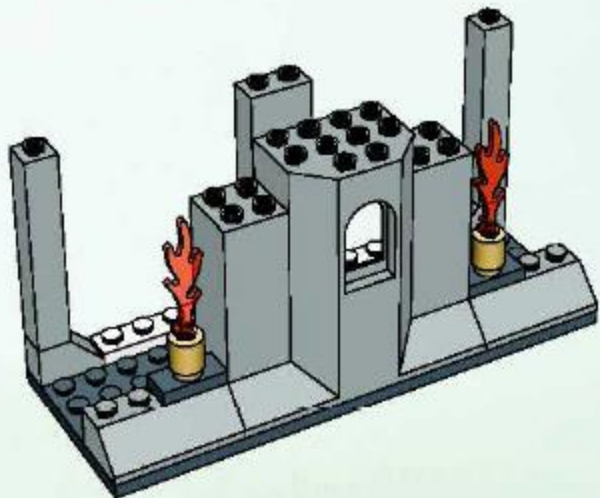

7

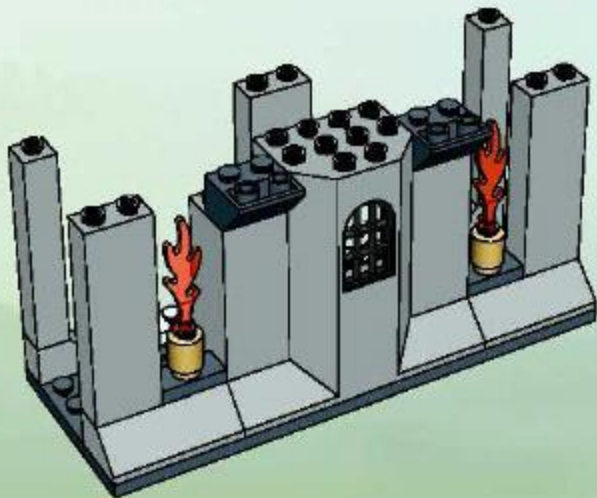

8

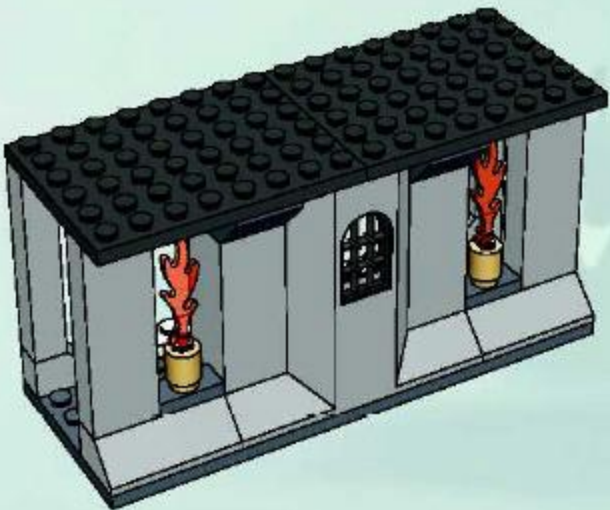

9

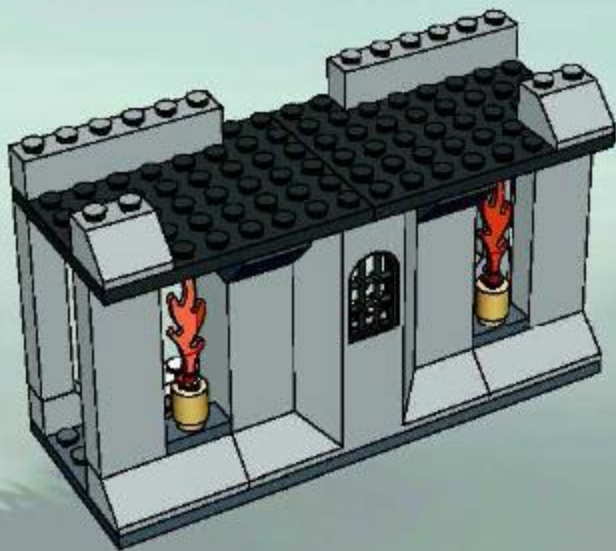

10

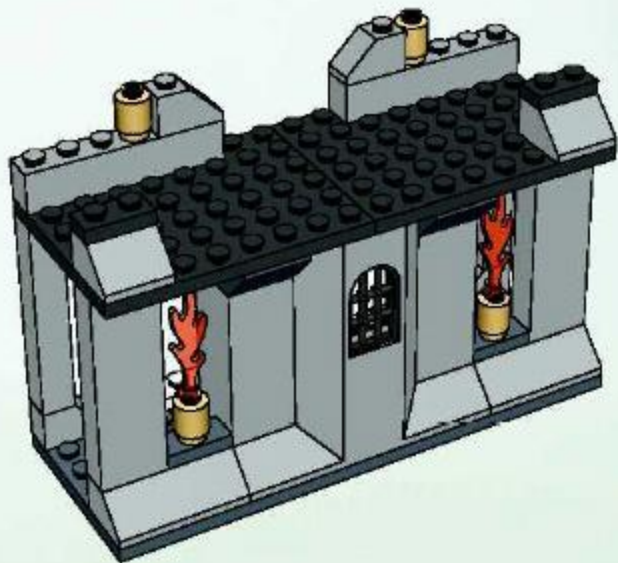

11

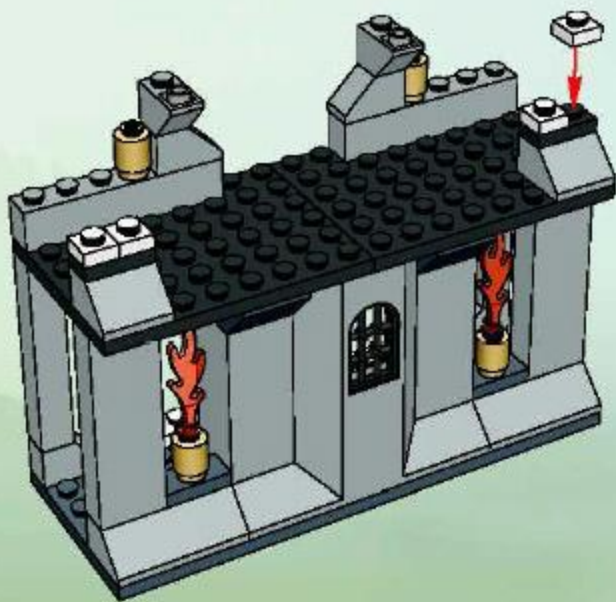



12

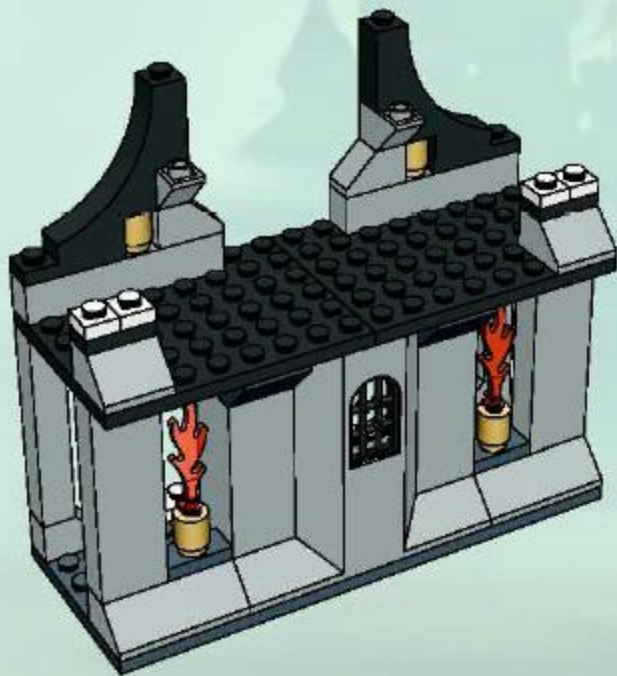

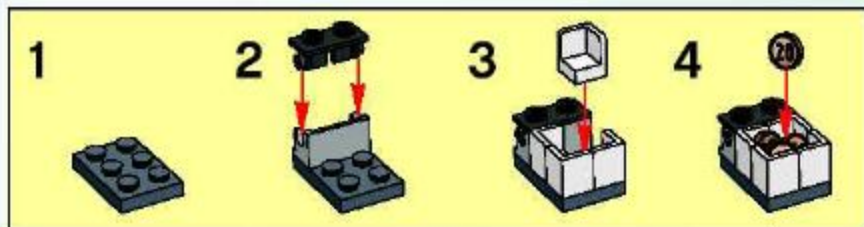

13

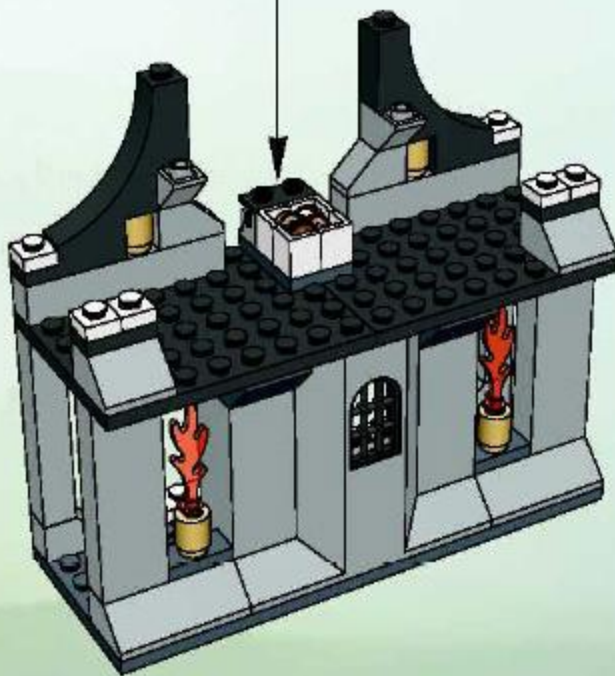

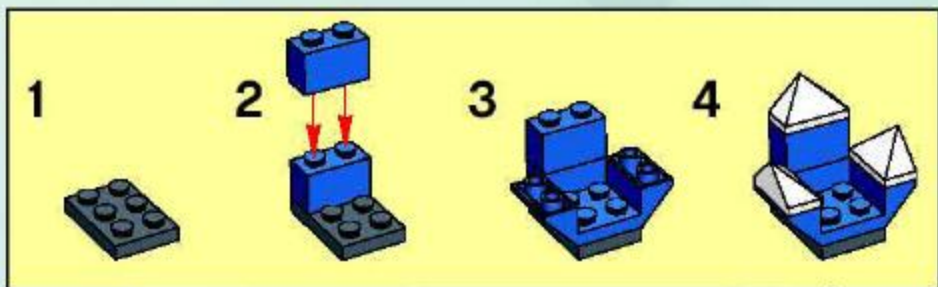

14

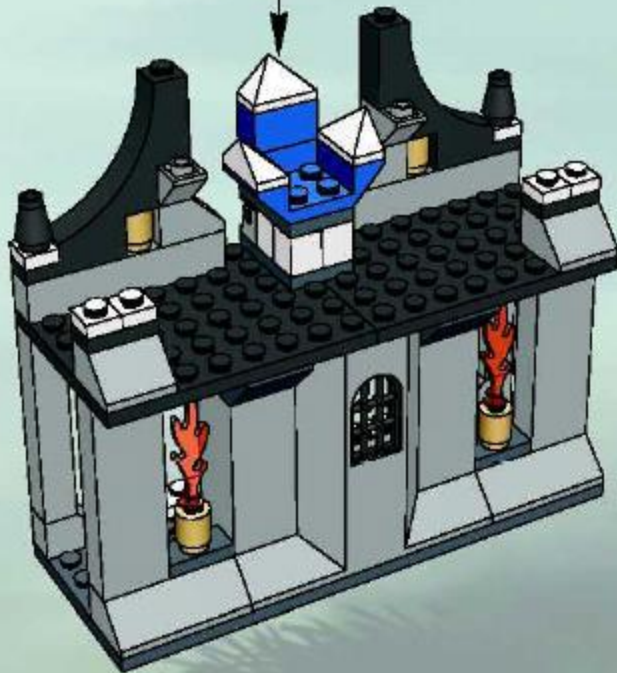

15

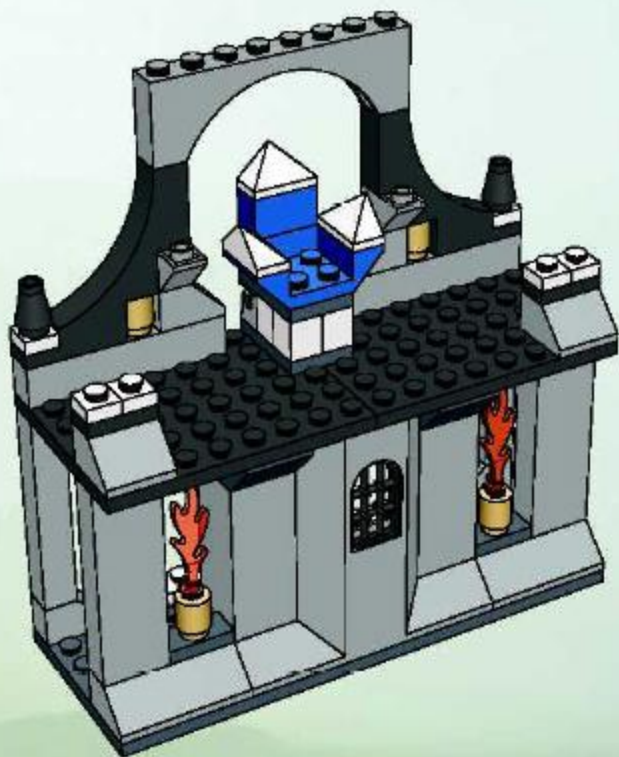



16

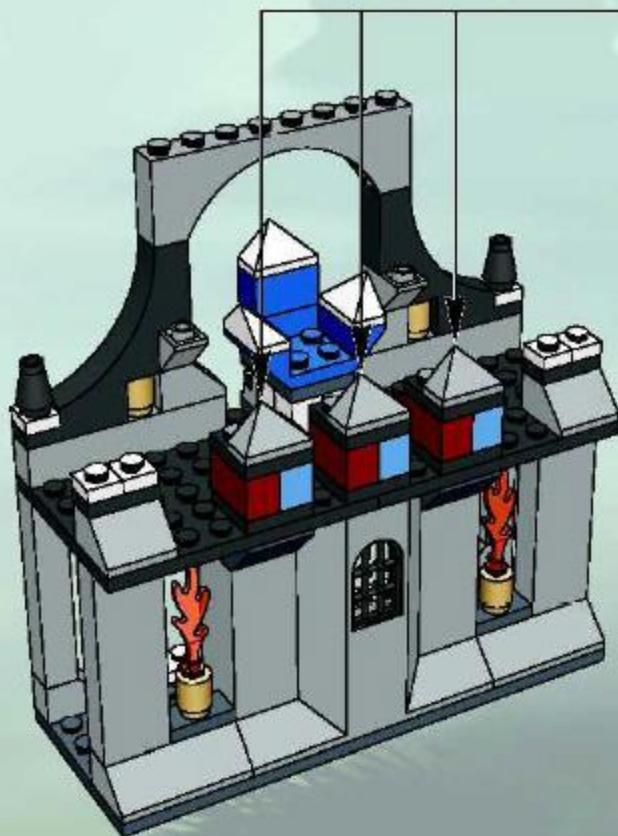

17

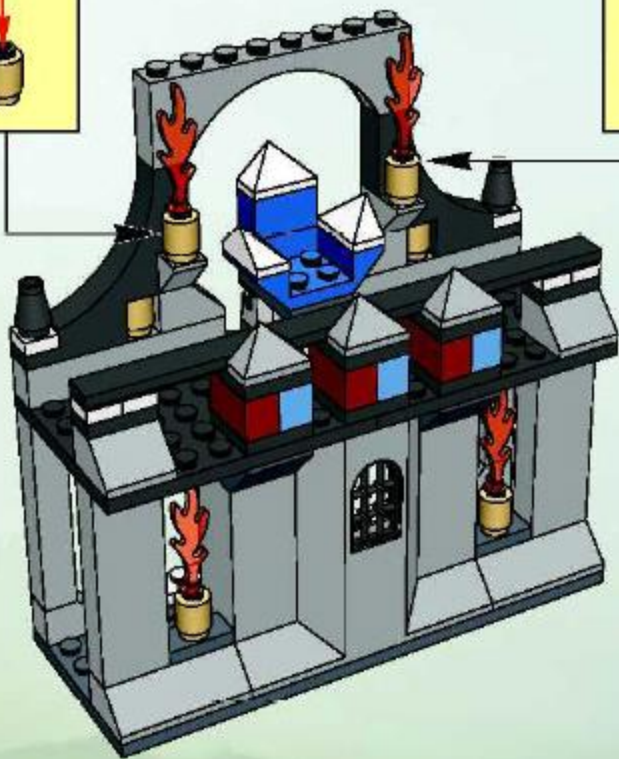
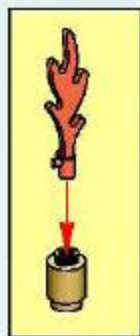
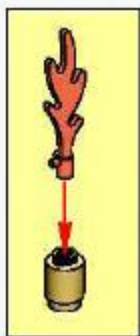

18



1



2



3



1



2



3



19

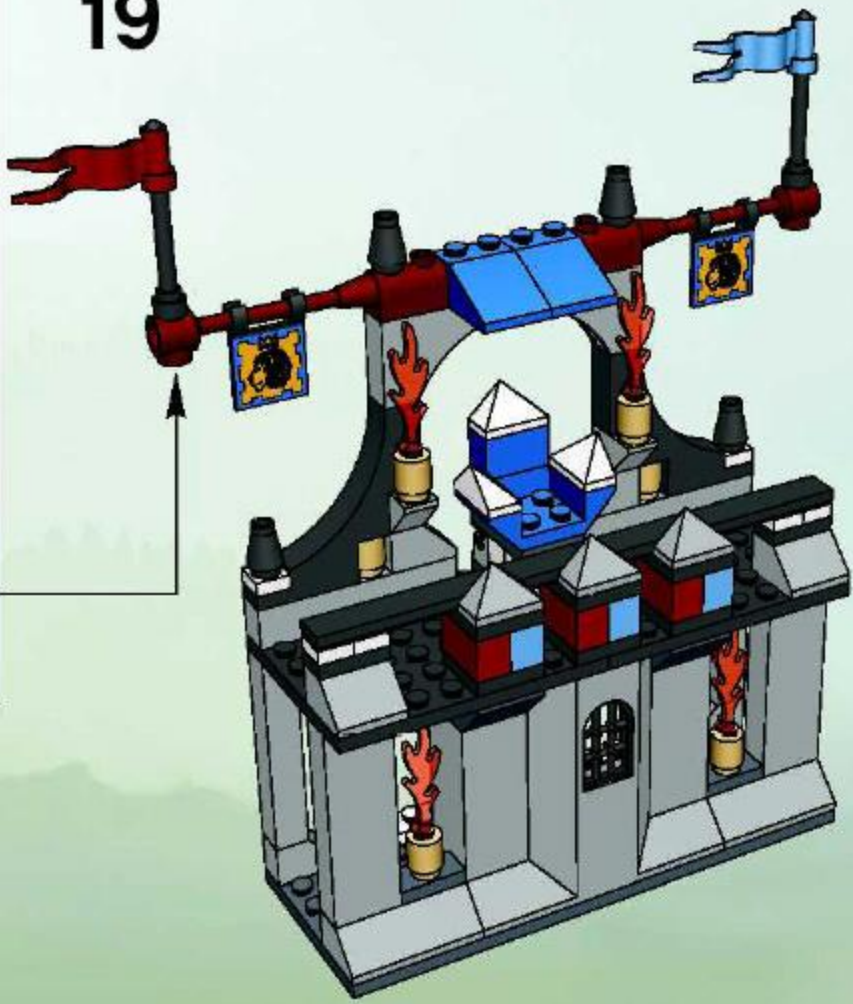



20

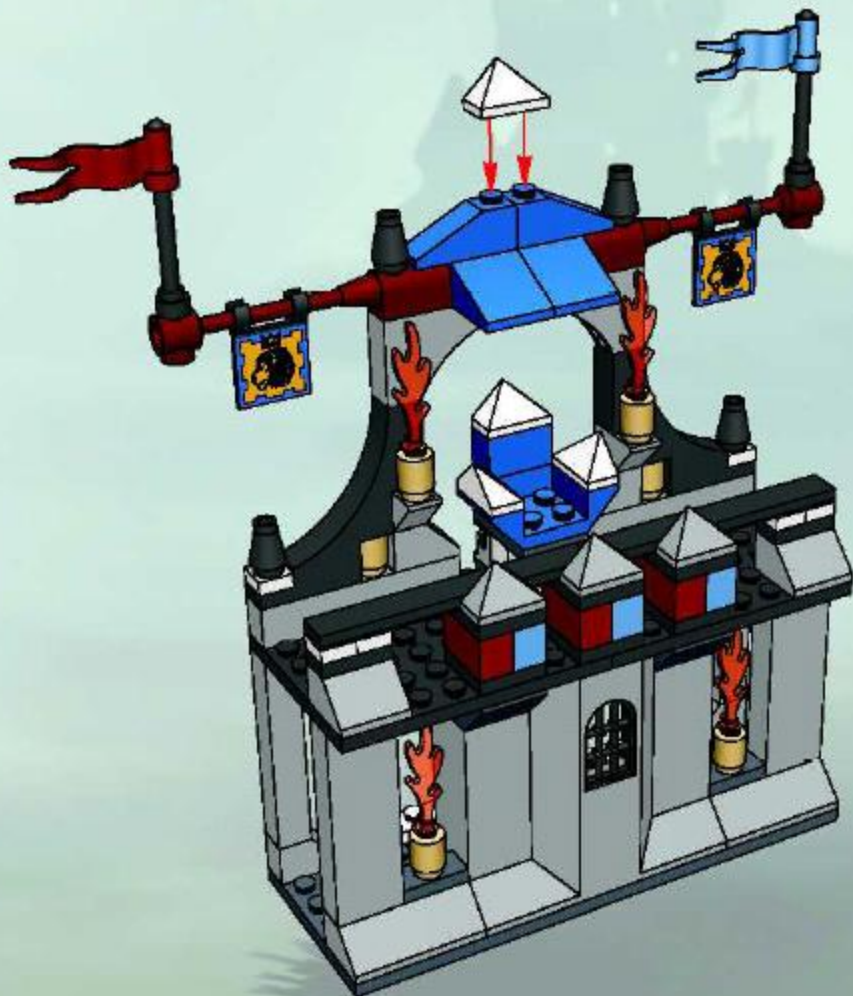

21





1



2



3



4



5



6



7



8





1



2

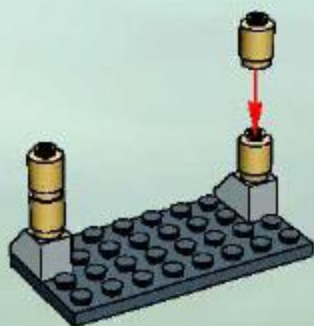

3



1



2

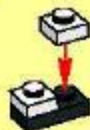

3



4

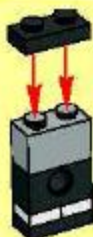

4

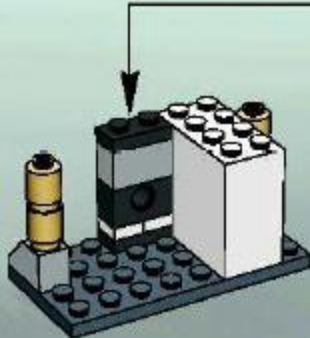

5

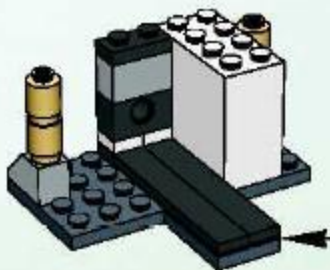

1



2



3



6

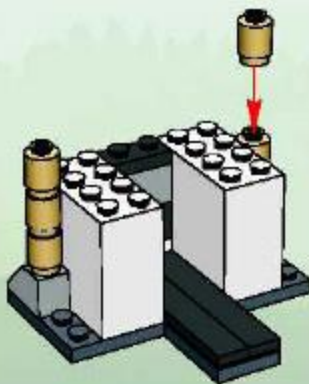

7

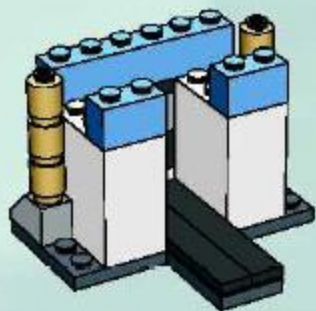

8

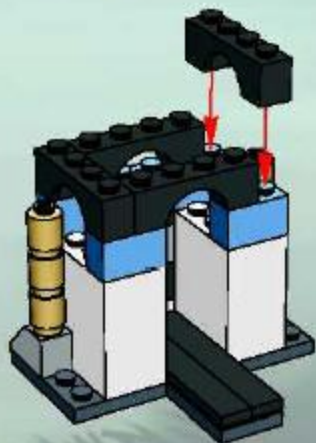

9

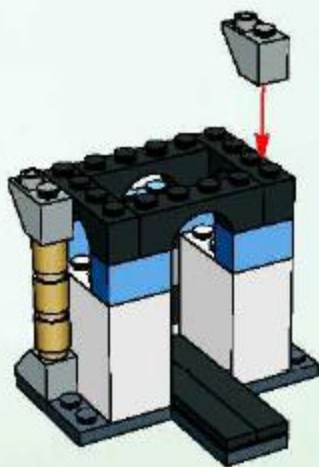

10

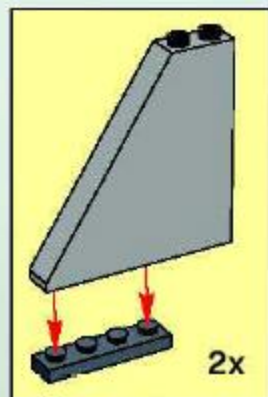
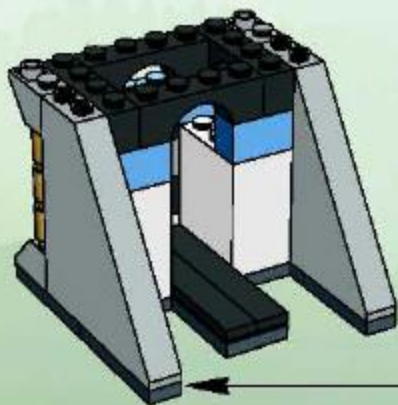



11

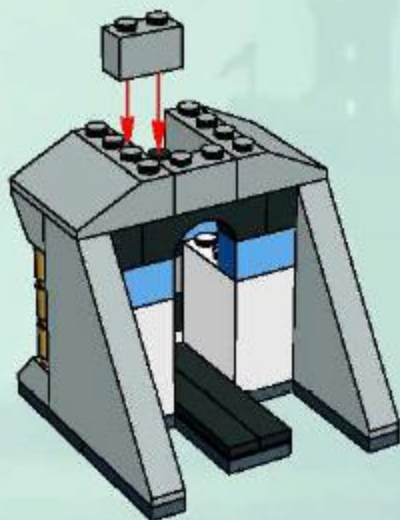

12

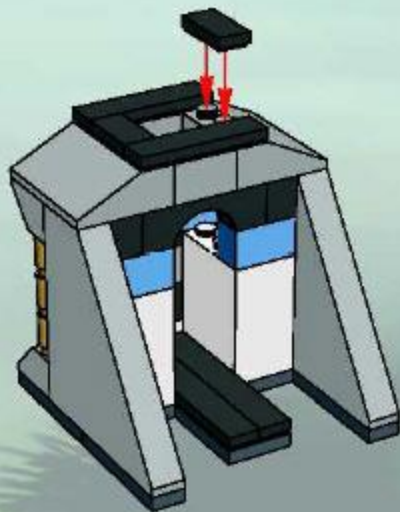

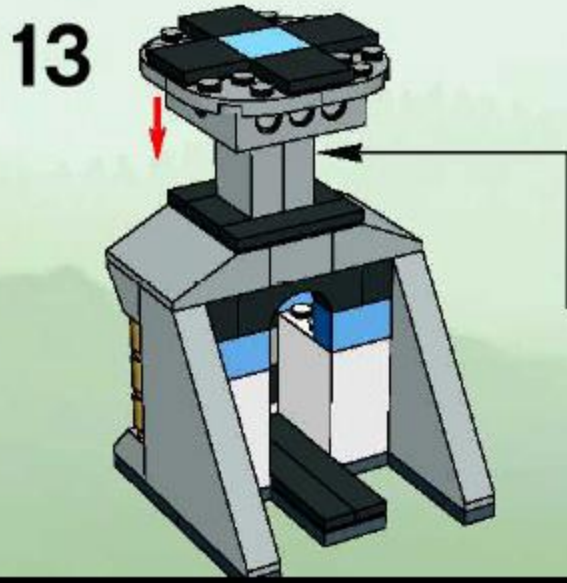
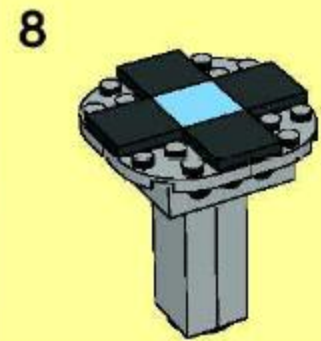
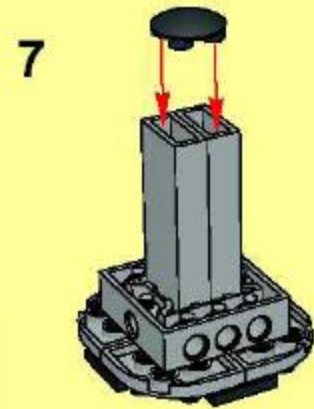
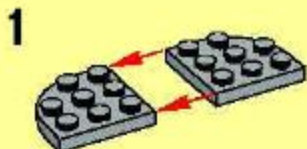



1



2

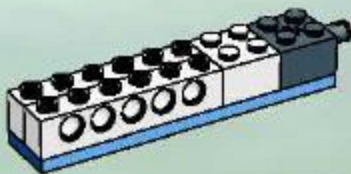

3

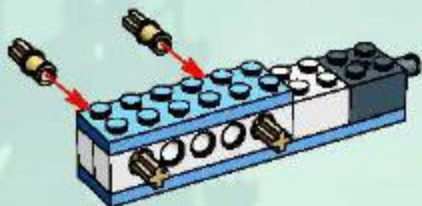

4

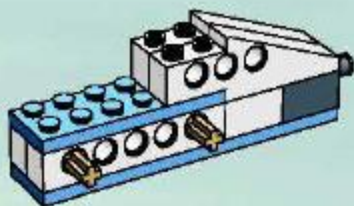

5

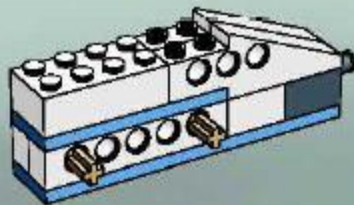

6

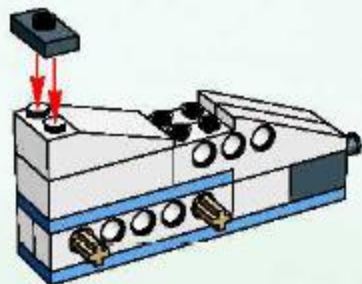

7

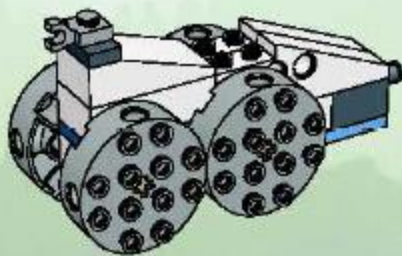

8

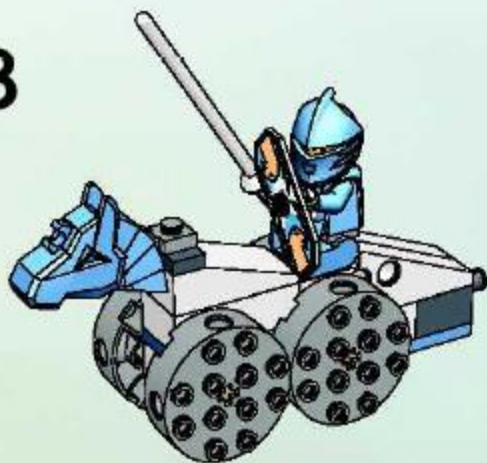

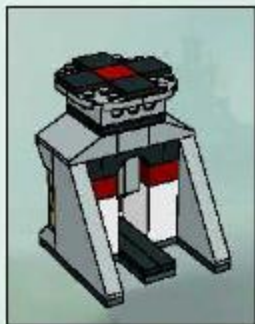

1



2

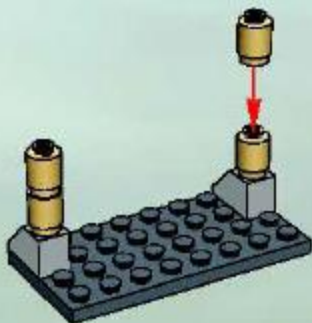

3

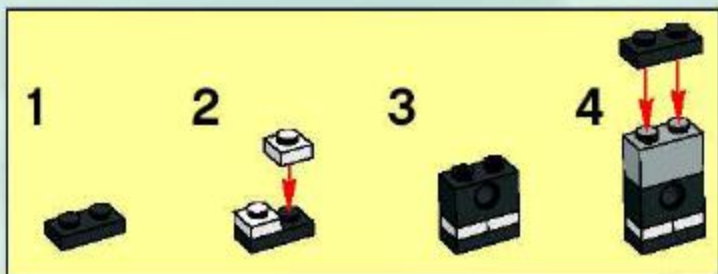

4

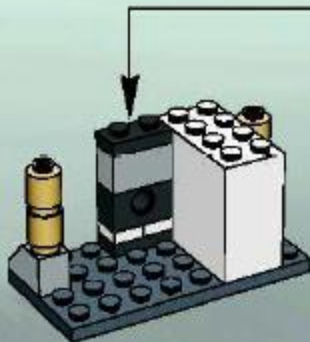

5

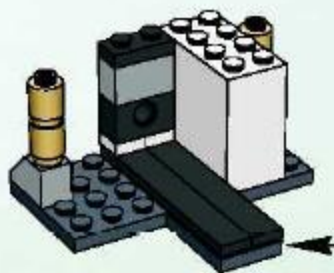

1



2



3



6

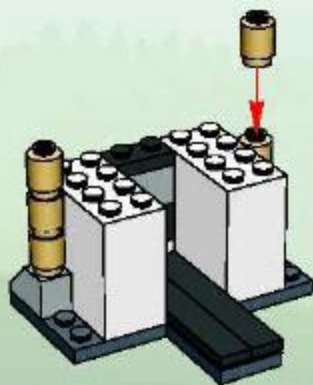

7

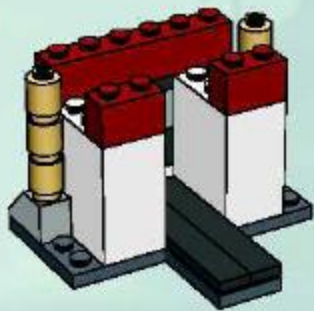

8

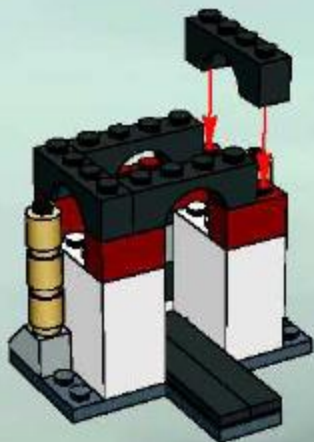

9

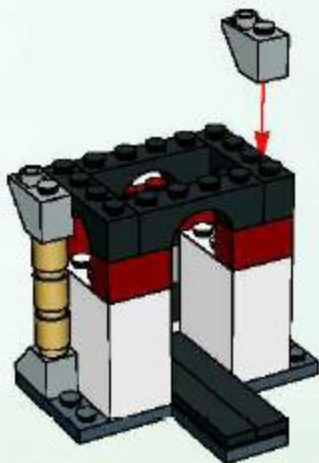

10

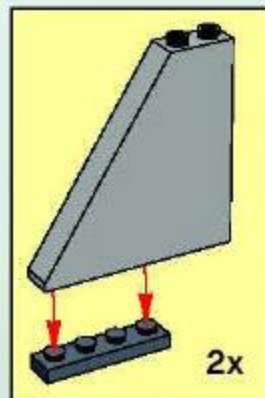
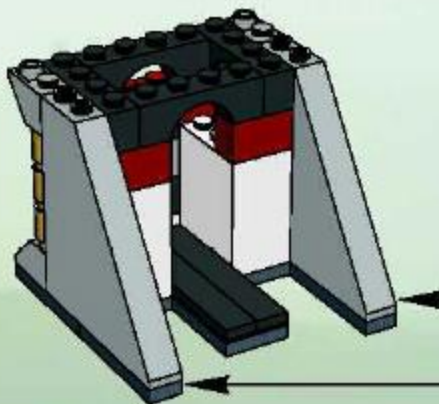



11

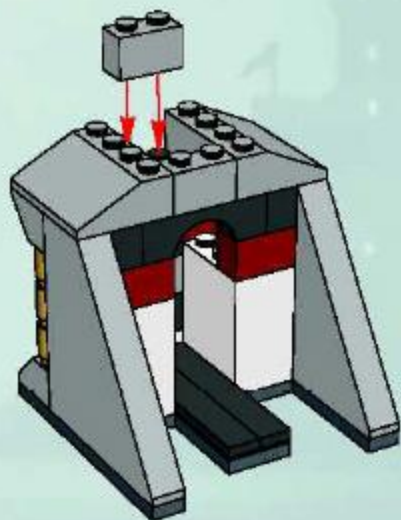

12

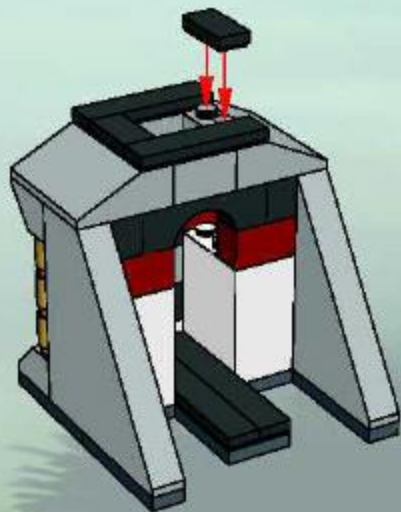

1

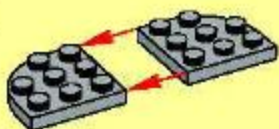

2



3



4



5



6



7

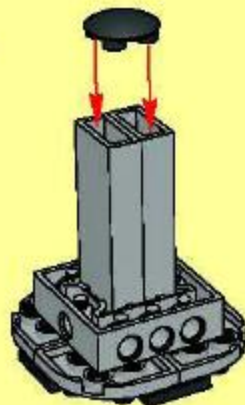

8



13

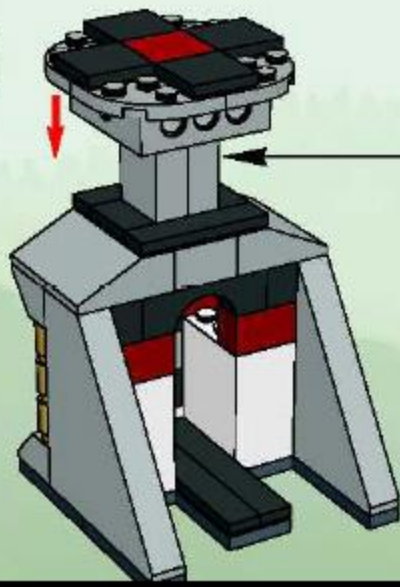



1



2



3



4



5



6

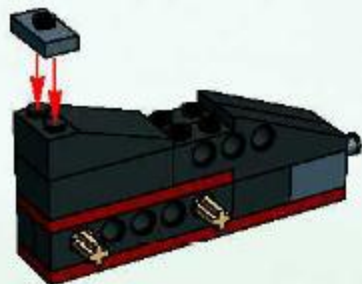

7



8



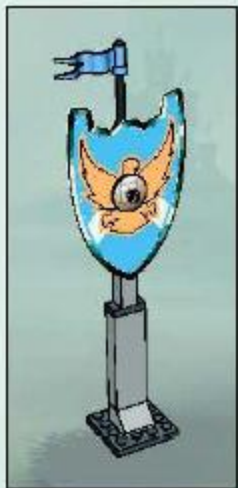

1



2



3



4

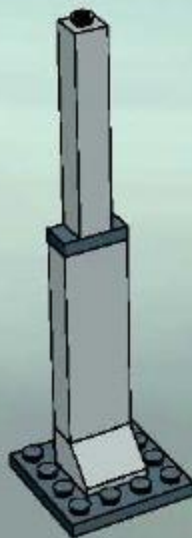

5

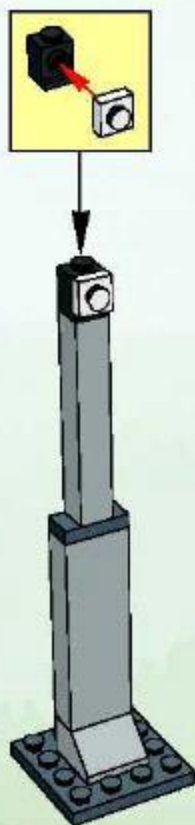

6

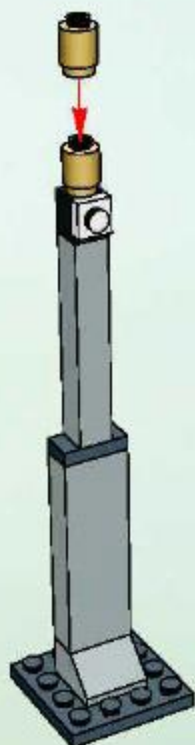

7

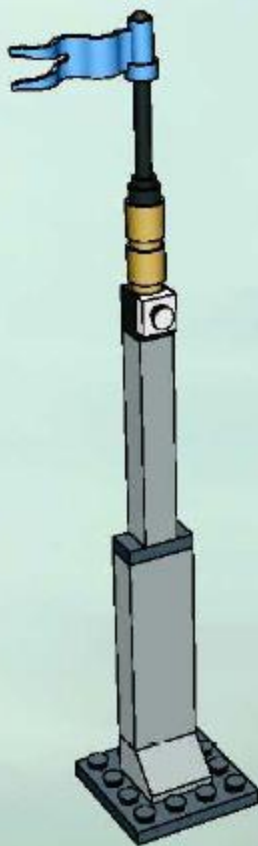

8



9



1



2





3

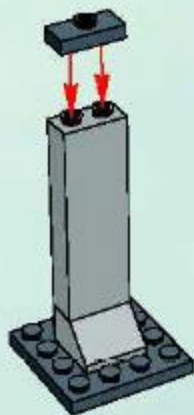

4

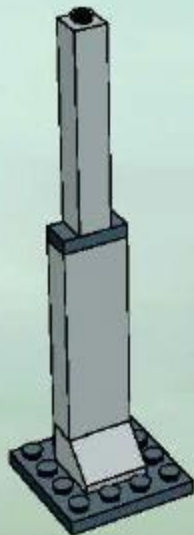

5

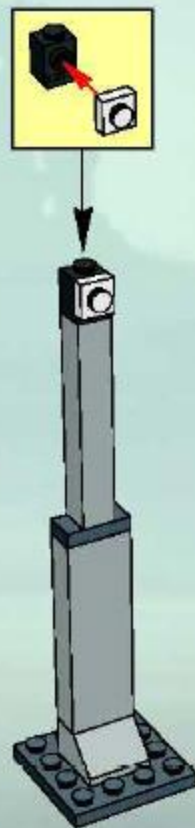

6

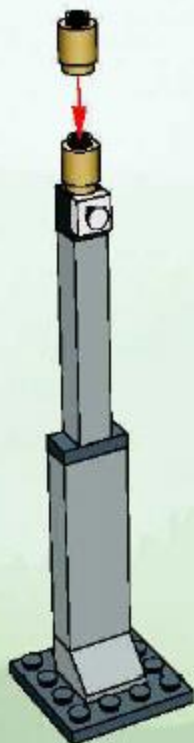

7

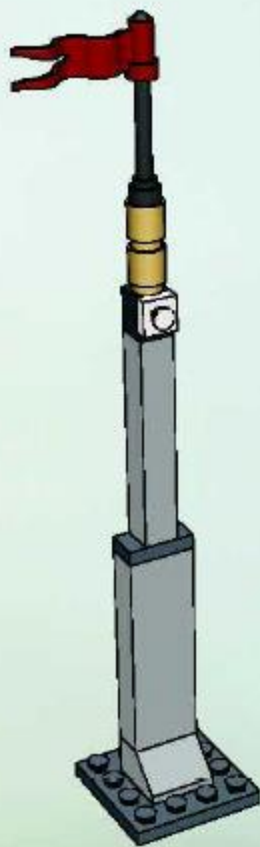

8



9



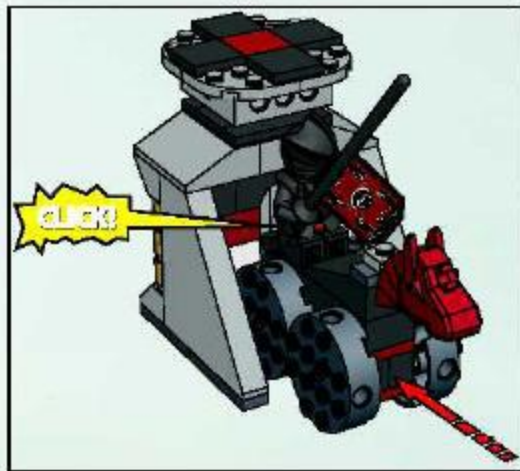

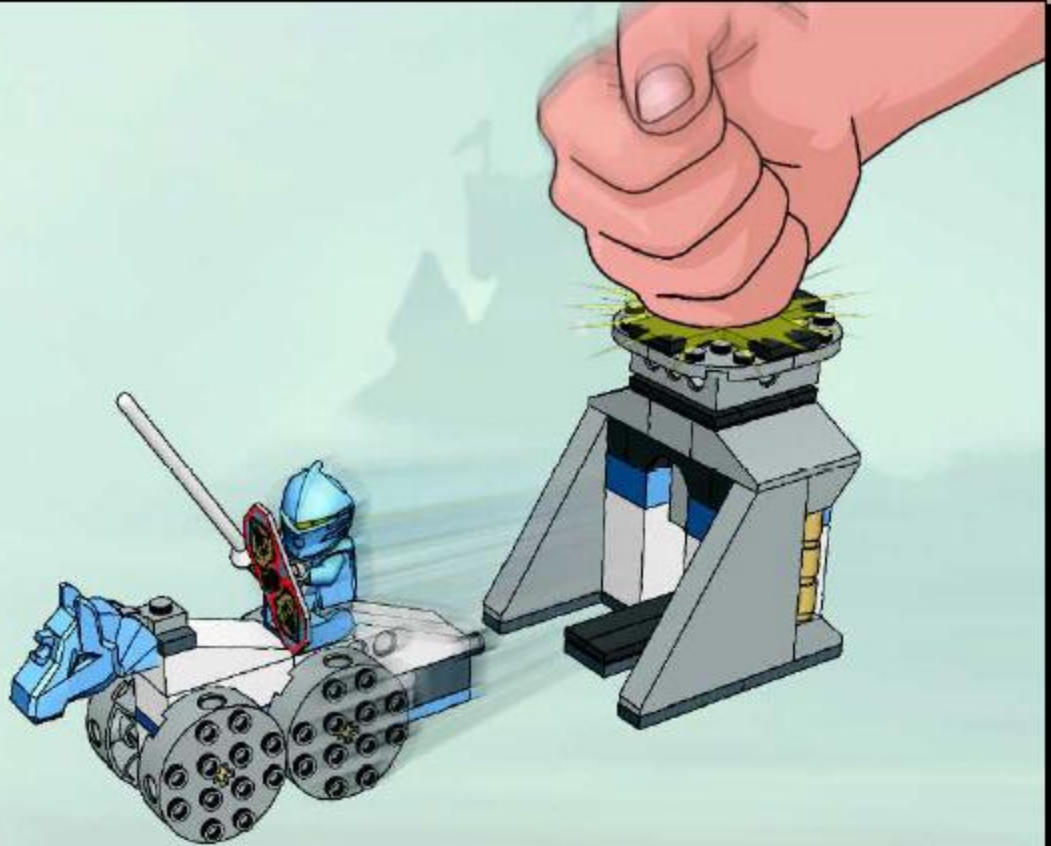

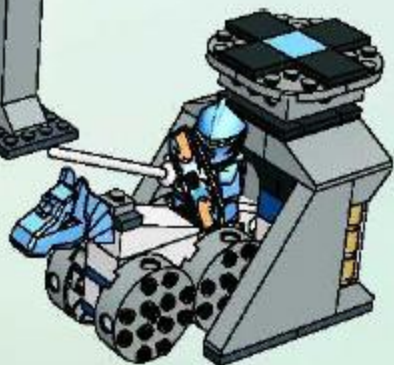

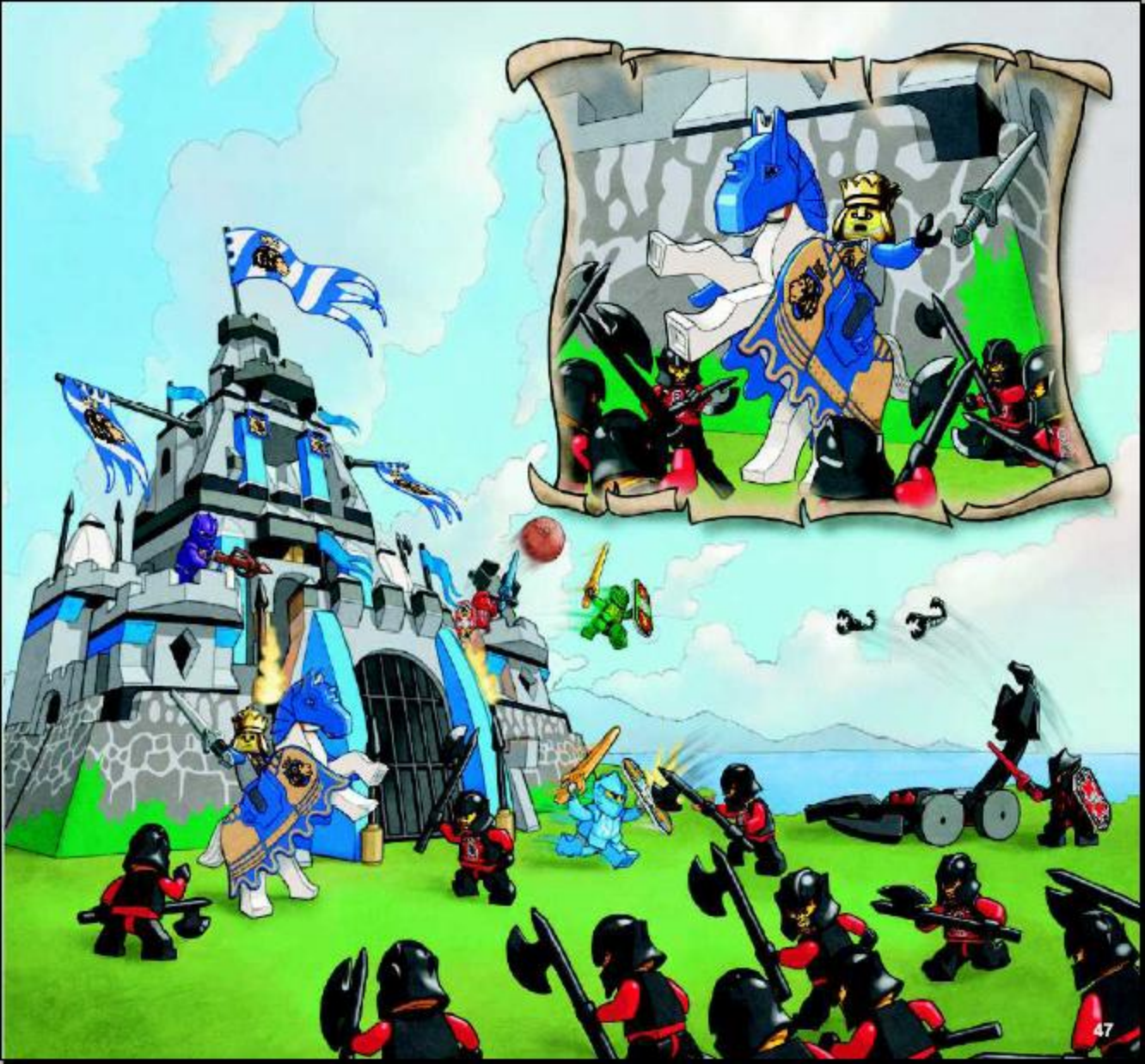









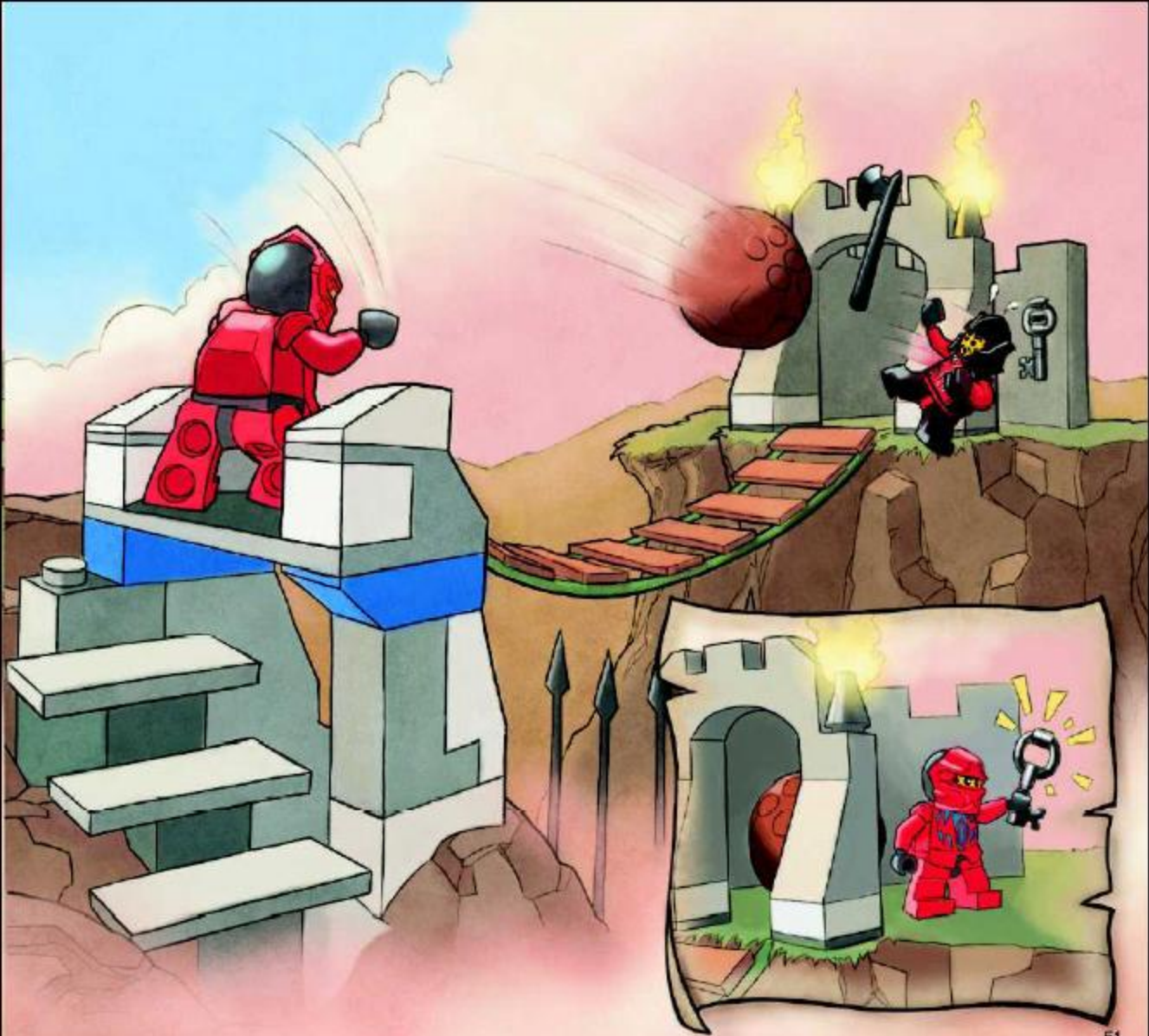







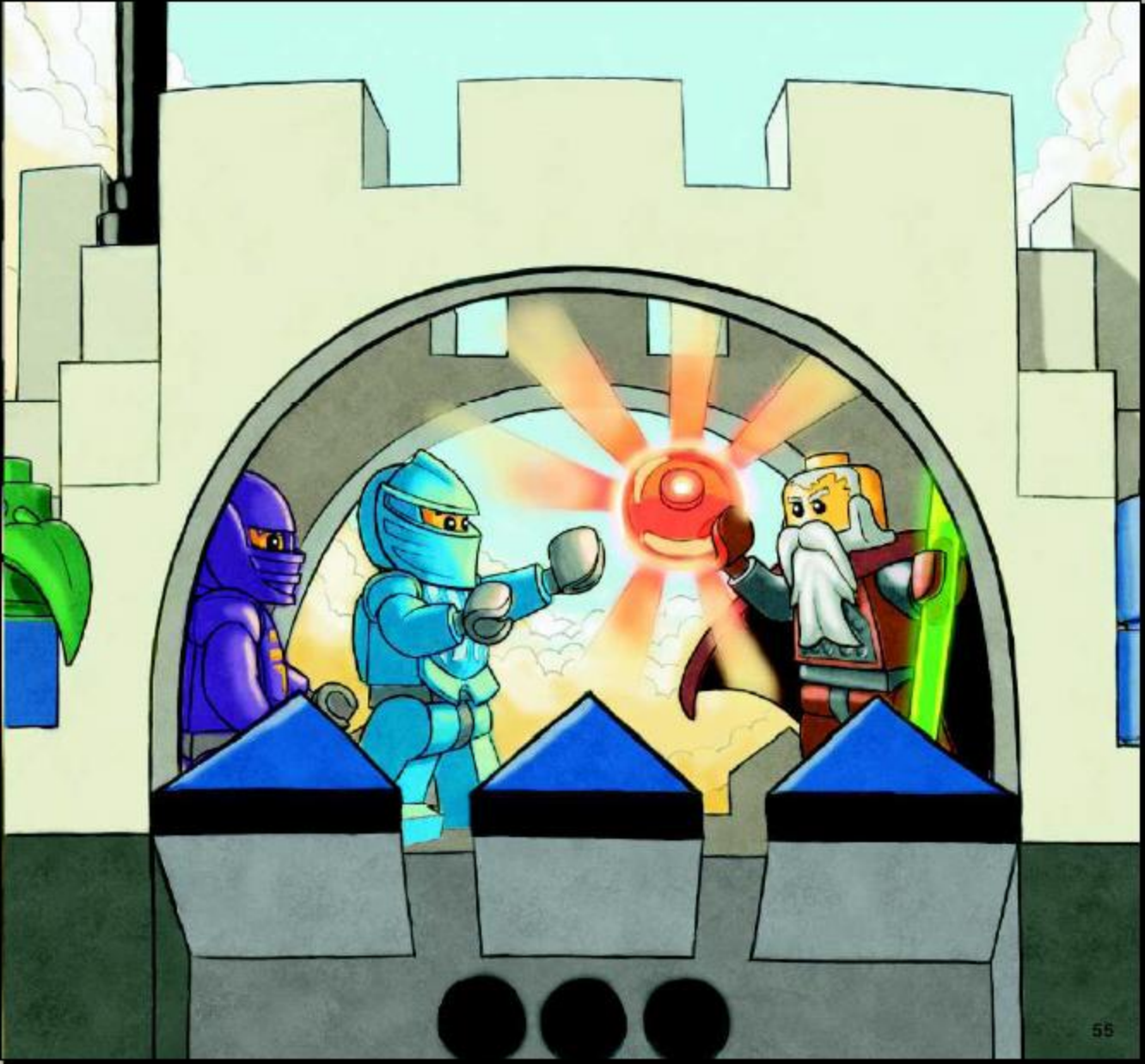











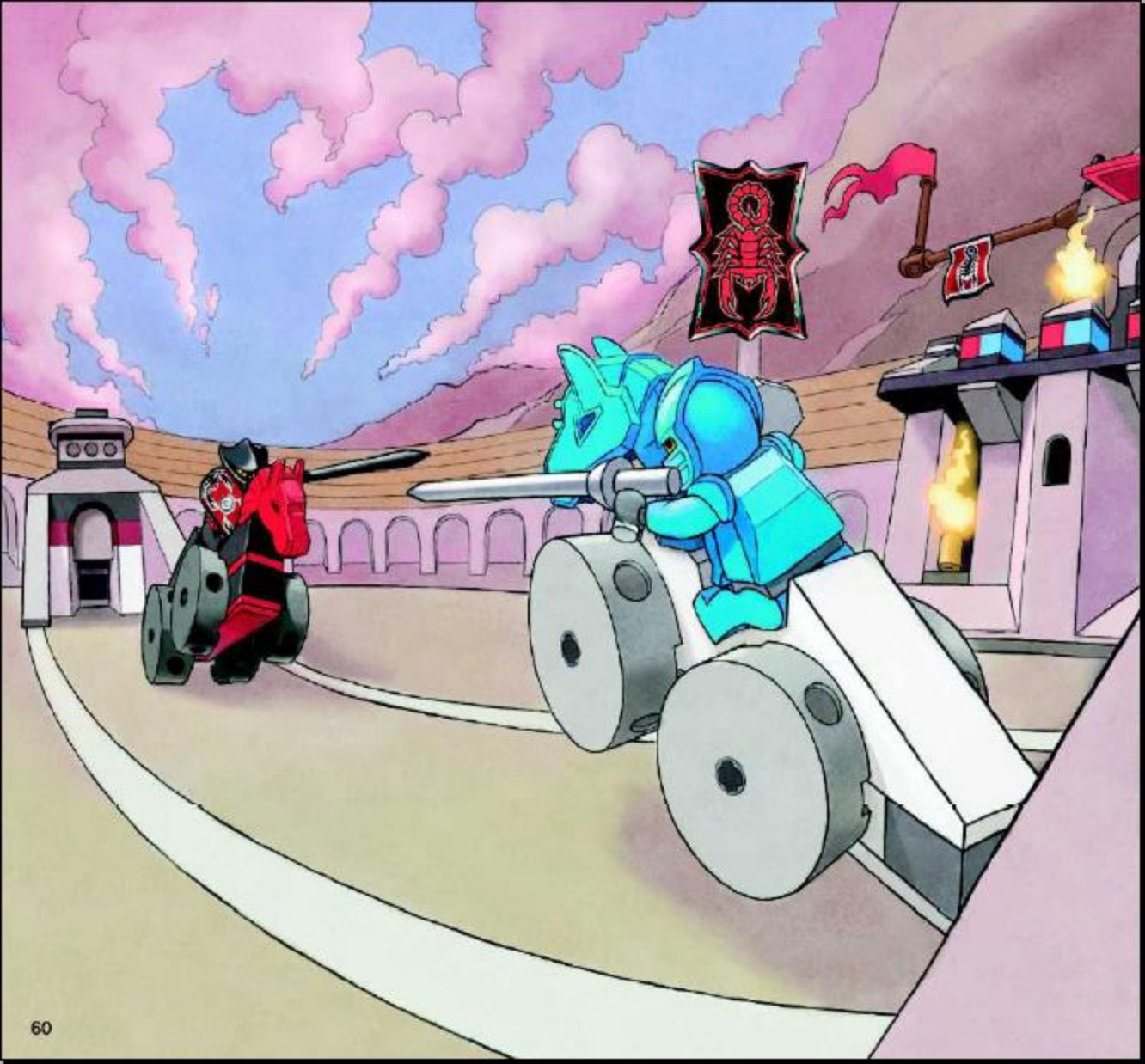





# Win! Gagne! Gewinne! 当たります



## WIN LEGO® PRODUCTS

We would like to know what you think about our new LEGO® product. If you could help us by answering a few questions you are in with a chance of winning an exciting LEGO prize. It will only take you about 3 minutes! Log on to the web address below for further instructions.



## Estimado usuario LEGO®

Al contestar algunas preguntas en Inglés, francés, alemán o japonés, en el sitio [www.acnielsen.aim.dk/lego](http://www.acnielsen.aim.dk/lego), podrás participar en el sorteo de algunos valiosos premios LEGO®.



## 皆様でレゴ®製品が大好きです

私たちは、皆様からのレゴ®製品に対するご意見が知りたいです。もしも、ご意見を聞かせていただければ、素晴らしいレゴ®賞品が当たるチャンスがあります。英語、フランス語、ドイツ語、または日本語で簡単な質問に答えるだけで、わずか3分程度で完了します。ぜひ、この機会にぜひ [www.acnielsen.aim.dk/lego](http://www.acnielsen.aim.dk/lego) にアクセスしてご参加ください。



## GAGNE DES PRODUITS LEGO®

Nous aimerions savoir ce que tu penses de ton nouveau produit LEGO®. Si tu veux bien nous aider en répondant à quelques questions, tu recevras peut-être bientôt un fantastique prix LEGO. Et cela ne te prendra que 3 minutes environ ! Tu obtiendras davantage d'informations en visitant le site Internet indiqué ci-dessous.



## Caro Consumidor de LEGO®

Ao responder a algumas perguntas em Inglês, Francês, Alemão ou Japonês no endereço [www.acnielsen.aim.dk/lego](http://www.acnielsen.aim.dk/lego) irá participar num concurso para ganhar valiosos prémios de LEGO®.



## GEWINNE LEGO® PRODUKTE

Wir sind sehr an deiner Meinung über dein neues LEGO® Produkt interessiert. Wenn du uns den Gefallen tust und ein paar Fragen beantwortest, kannst du einen tollen LEGO Preis gewinnen. Das Ganze dauert nur etwa 3 Minuten! Gehe einfach zu der unten angegebenen Webadresse - dort findest du weitere Informationen.



## Kedves Új LEGO® Vásárló!

Ha ellátogat az [www.acnielsen.aim.dk/lego](http://www.acnielsen.aim.dk/lego) honlapra és ott angol, francia, német vagy japán nyelven megválaszol néhány kérdést, akkor részt vehet egy versenyben, amelyben értékes LEGO® ajándékot nyerhet.

[www.acnielsen.aim.dk/LEGO](http://www.acnielsen.aim.dk/LEGO)



**LEGO**

# KNIGHTS KINGDOM



4200082



8786 **VLADEK**



8784 **RASCUS**



8785 **SANTIS**



8783 **JAYKO**



8782 **DANJU**