



4494

**STAR
WARS**™

Imperial Shuttle™

4227000

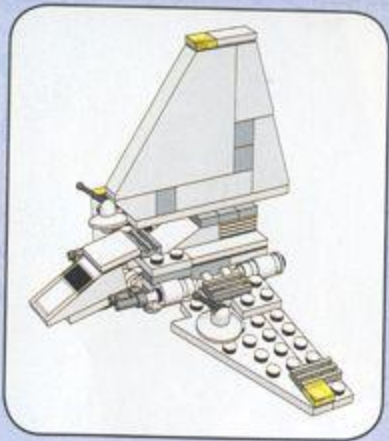

2

1

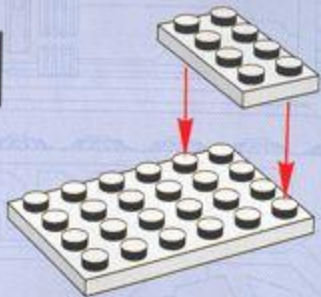

2



3

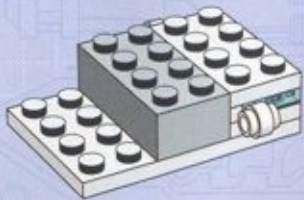

4

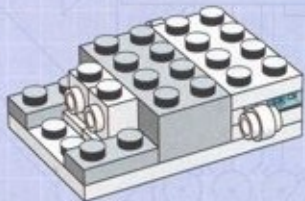

5

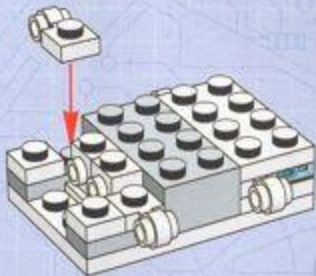

6

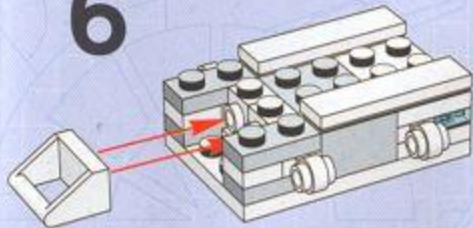

7

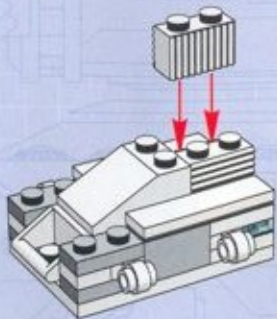

8

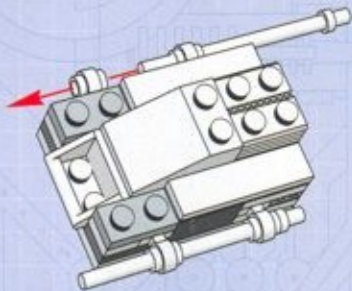

9

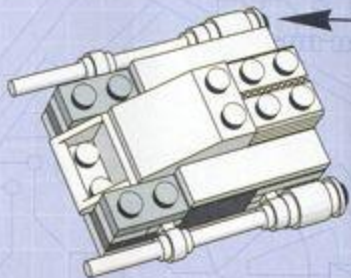

10

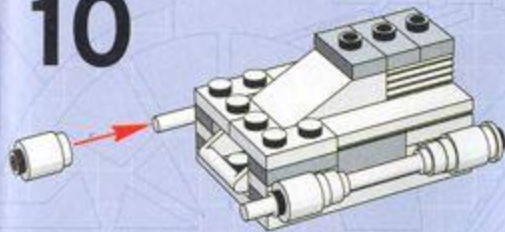

11

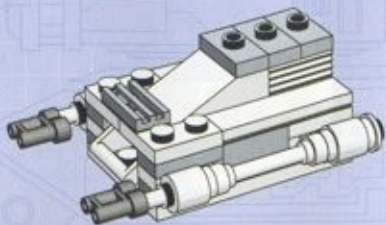

12

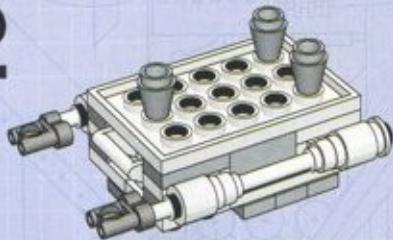

1



3



2



4



5

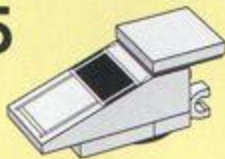

1

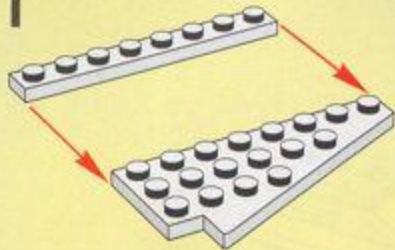

2



3



4



1

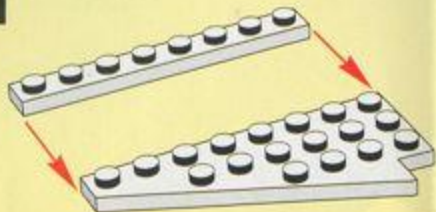

2



3

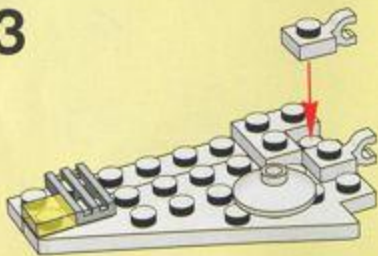

4



15

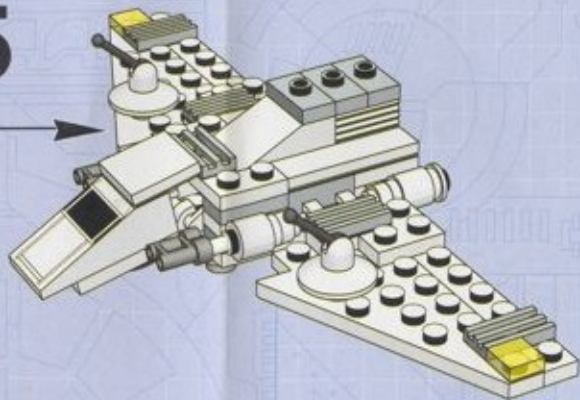

1

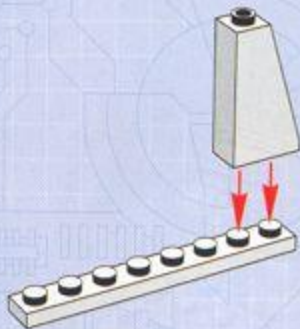

2

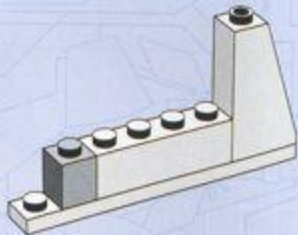

3

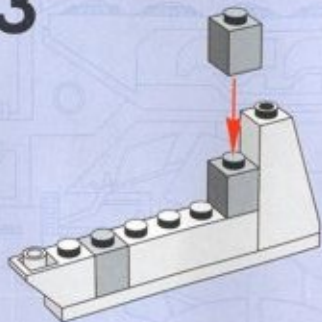

4



5



6

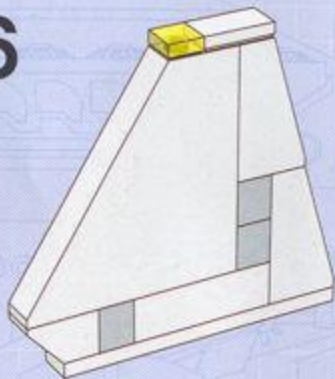

16

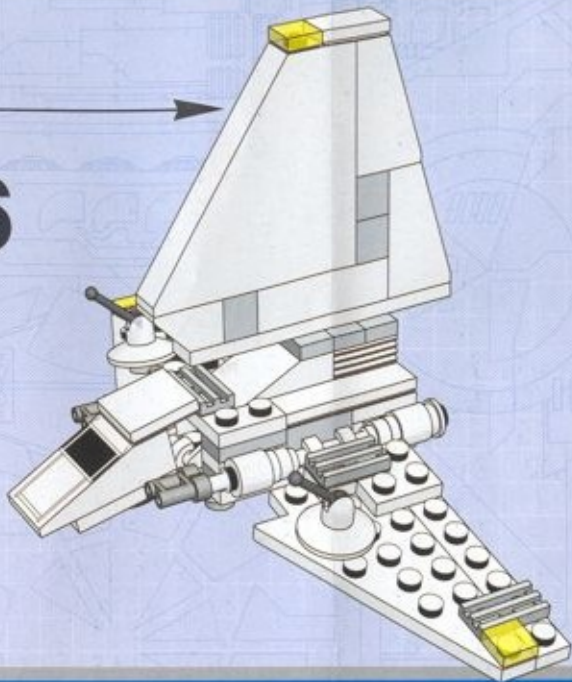



4492



4493



4494



4495

Win! Gagne! Gewinne! 当たります



WIN LEGO® PRODUCTS

Log on to the web address below for further instructions.



GAGNE DES PRODUITS LEGO®

Tu obtiendras davantage d'informations en visitant le site Internet indiqué ci-dessous.



GEWINNE LEGO® PRODUKTE

Gehe einfach zu der unten angegebenen Webadresse - dort findest du weitere Informationen.



抽選でレゴ®製品が当たります

詳しくは、以下のウェブアドレスまでアクセスしてください。



ESTIMADO USUARIO LEGO®

Al contestar algunas preguntas en inglés, francés, alemán o japonés, en el sitio www.acnielsen.aim.dk/lego, podrás participar en el sorteo de algunos valiosos premios LEGO®.



CARO CONSUMIDOR DA LEGO®

Ao responder a algumas perguntas em Inglês, Francês, Alemão ou Japonês no endereço www.acnielsen.aim.dk/lego irá participar num concurso para ganhar valiosos prémios da LEGO®.



KEDVES IFJÚ LEGO® VÁSÁRLÓ

Ha ellátogatasz a www.acnielsen.aim.dk/lego honlapra és ott angol, francia, német vagy japán nyelven megválaszolsz néhány kérdést, akkor részt veszel egy versenyben, amelyben értékes LEGO® díjakat nyerhetsz.

www.acnielsen.aim.dk/lego

The LEGO logo is positioned in the top left corner, featuring the word "LEGO" in white, bold, sans-serif font inside a red square.

STAR WARS

A blue square icon with a white right-pointing arrow.

www.LEGO.com

A white lightning bolt graphic pointing towards the text box.

For more exciting LEGO® Star Wars™
information go to:
www.LEGO.com/starwars

LEGO, the LEGO logo and the Minifigure are trademarks of/son des marques de commerce de/son marcas registradas de LEGO Group. ©2004 The LEGO Group.
©2004 Lucasfilm Ltd. & TM/AC. All rights reserved. Used under authorization./Tous droits réservés. Utilisé sous autorisation./Todos los derechos reservados. Usado bajo autorización.

A circular icon containing a stylized head of a Minifigure.

SERVICE
www.LEGO.com

