

LEGO

7-12

**STAR
WARS**



7119

4170324

TWIN-POD CLOUD CAR

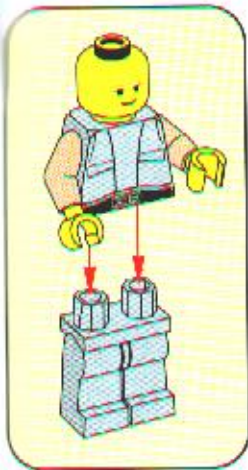

1

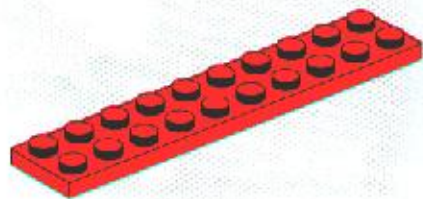

2

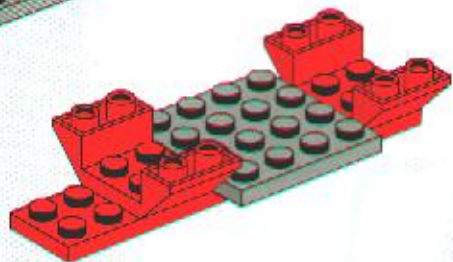
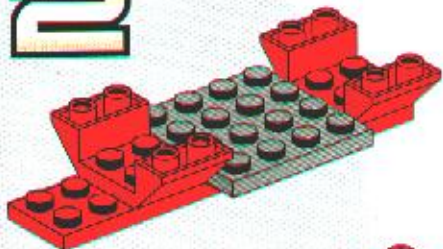

B

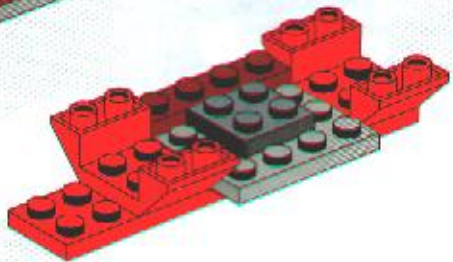
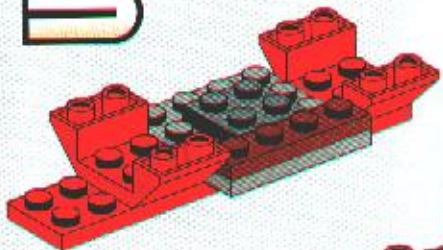

1

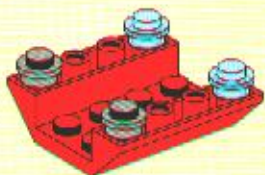

2

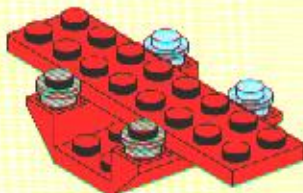

3

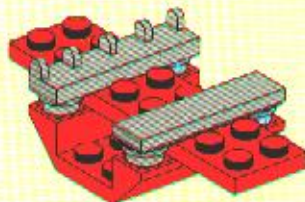

4

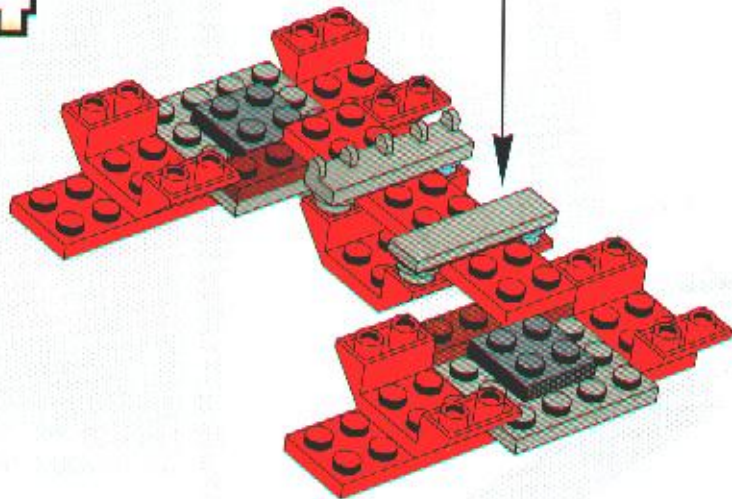

5

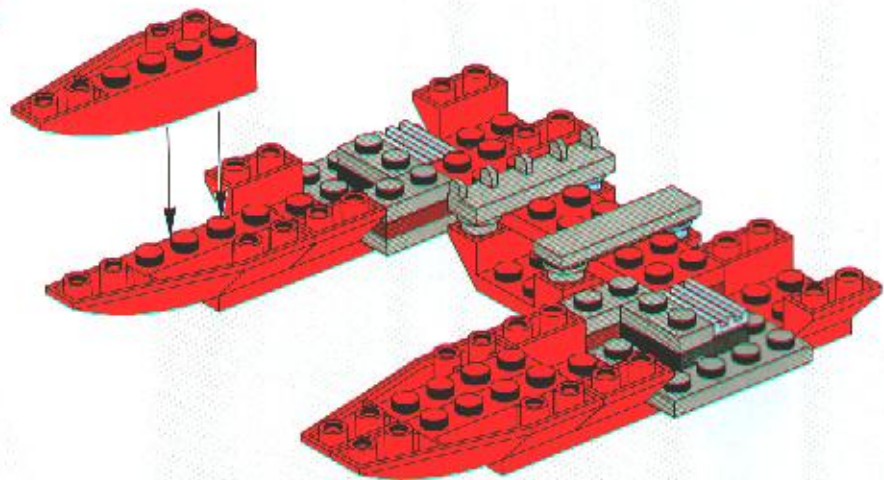

6

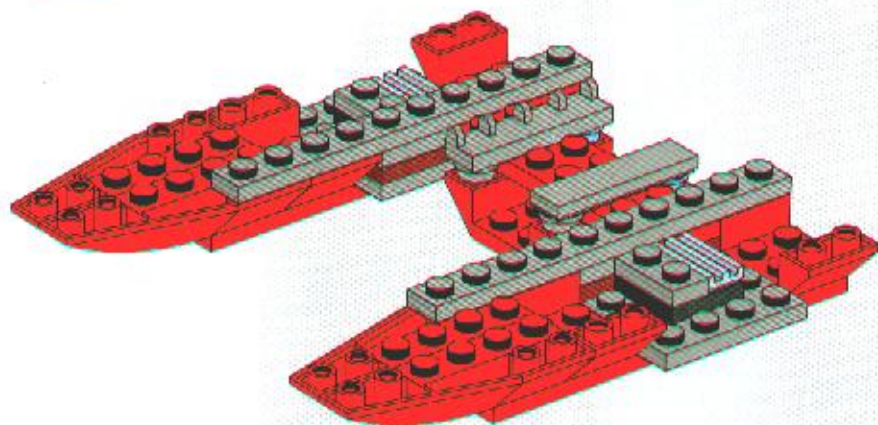

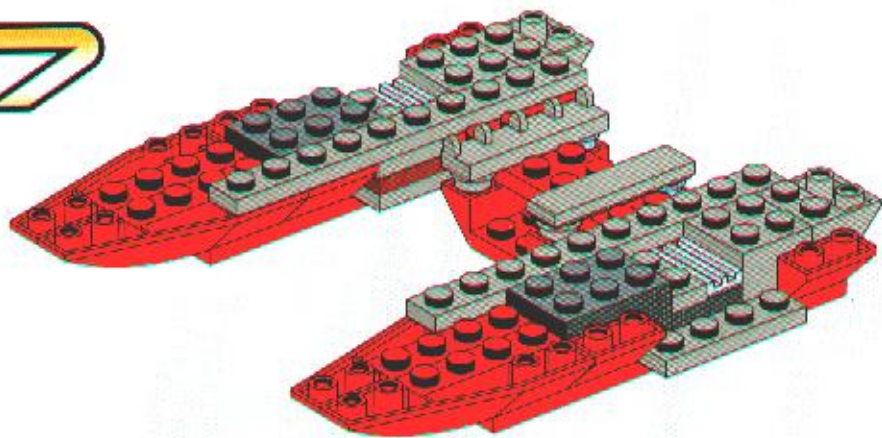

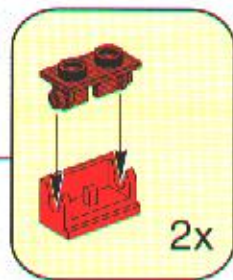
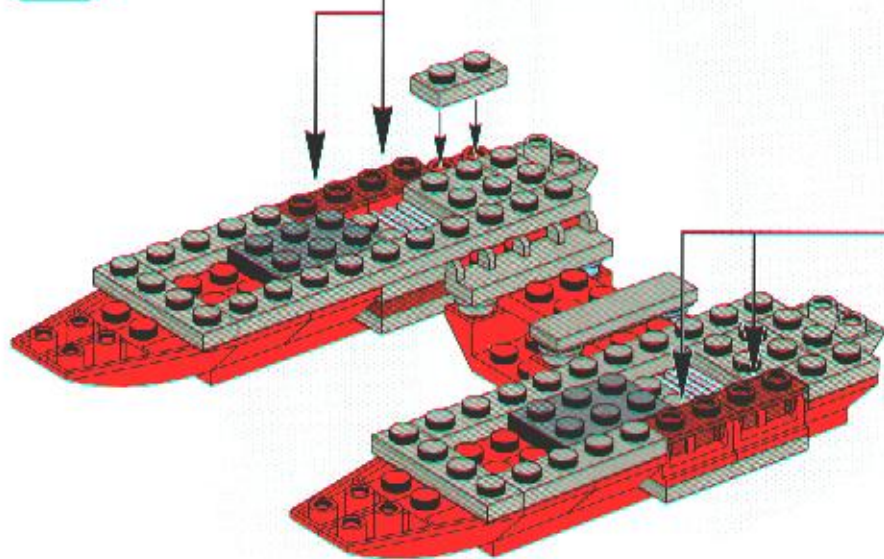
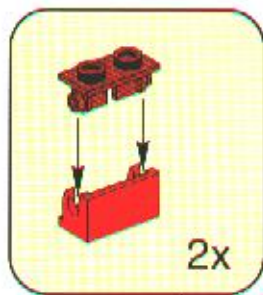

10

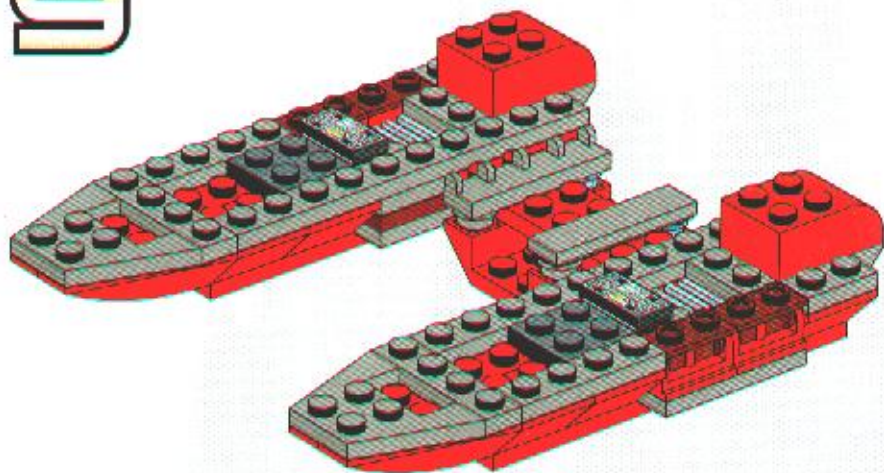

10

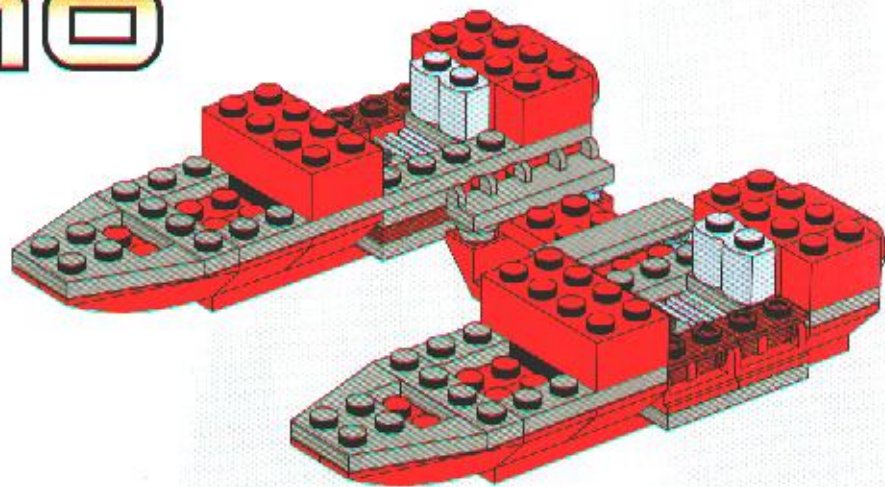

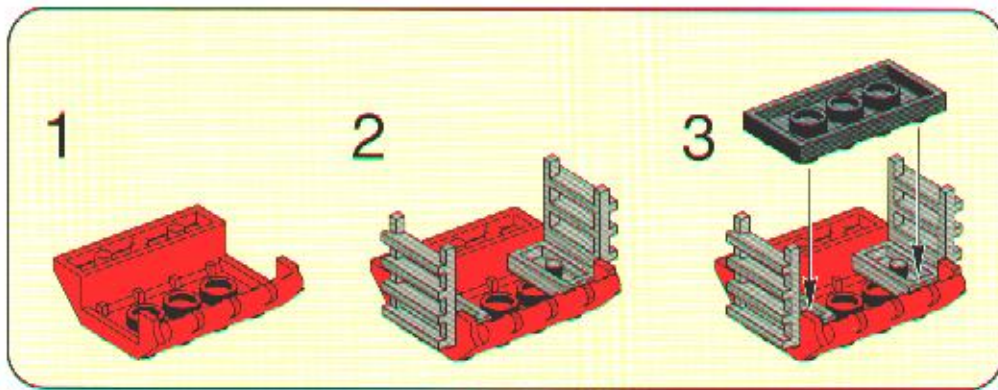

11

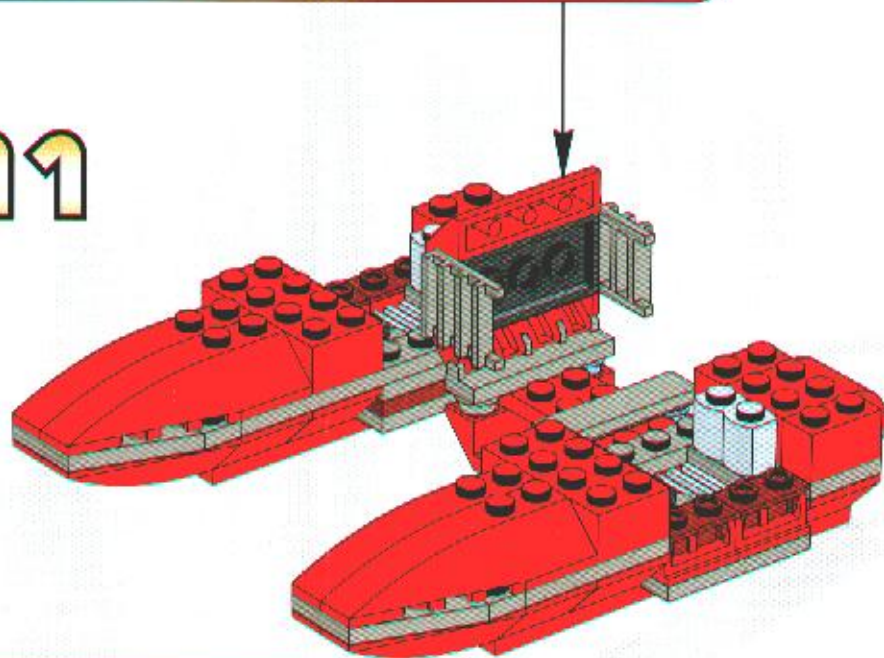

12

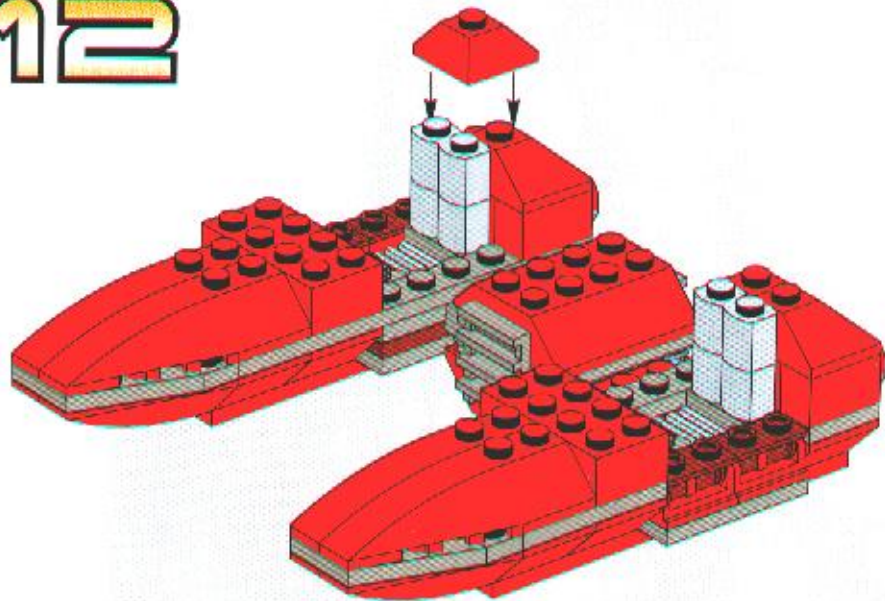

13

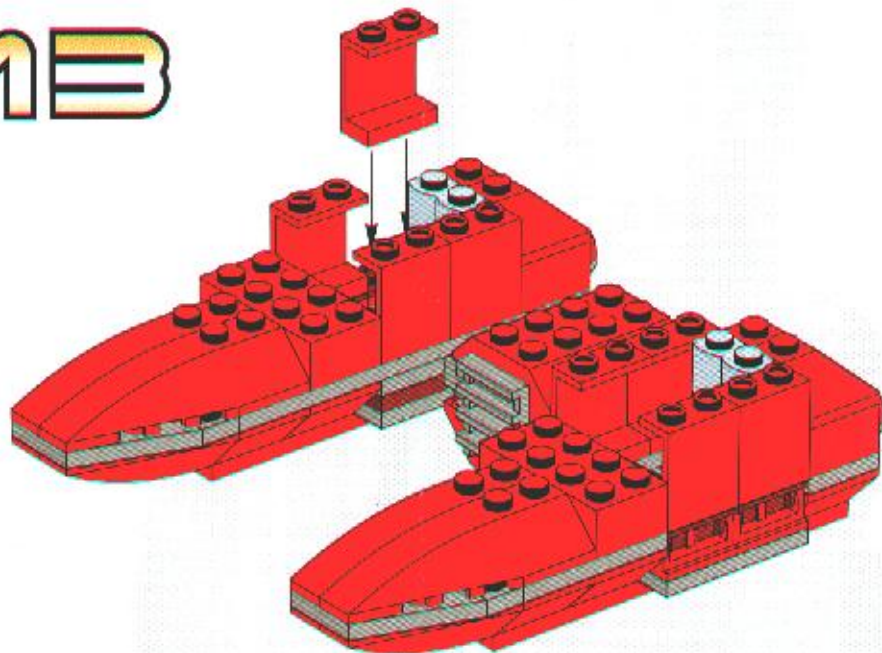

14

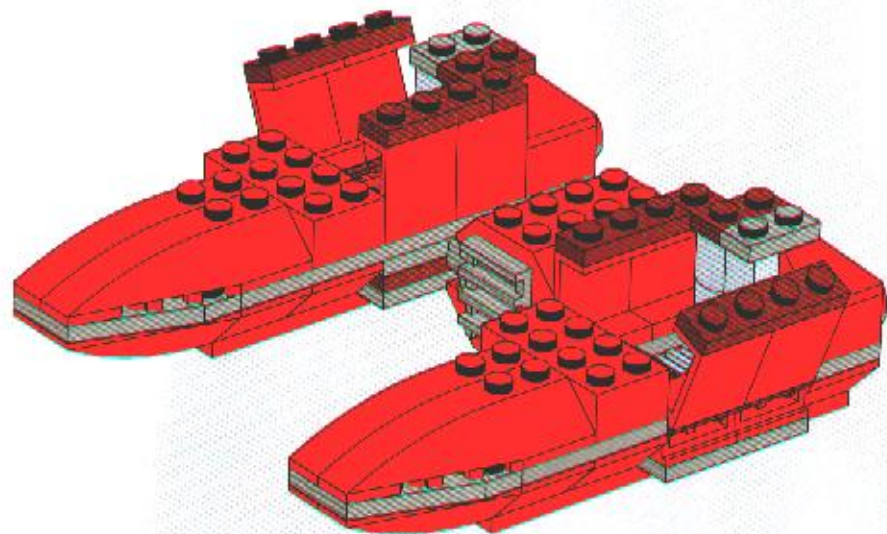

15

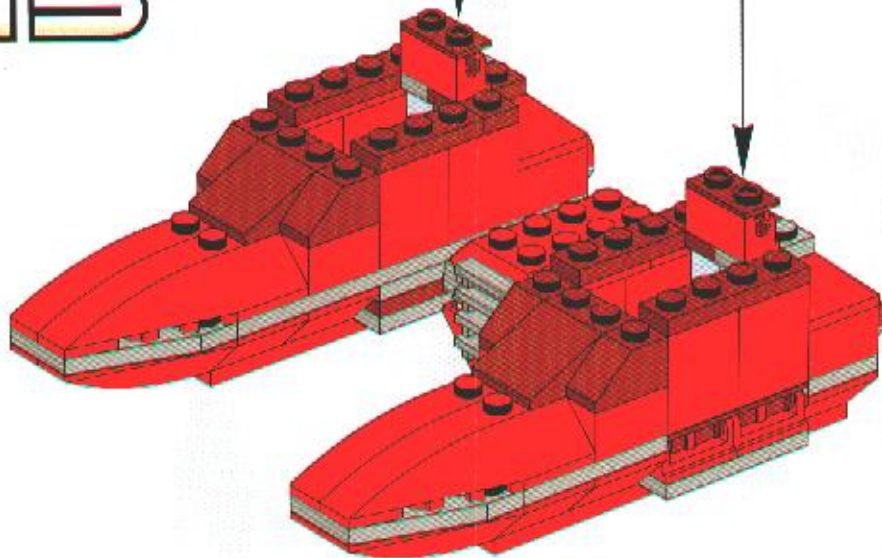
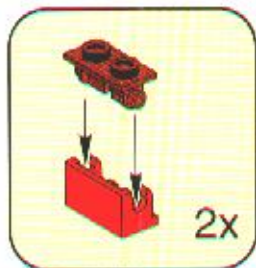

16

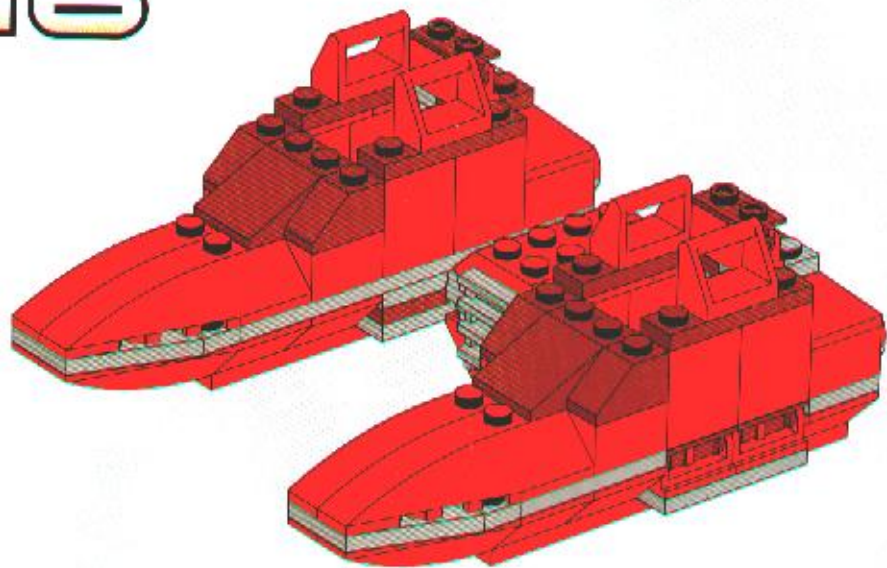

17

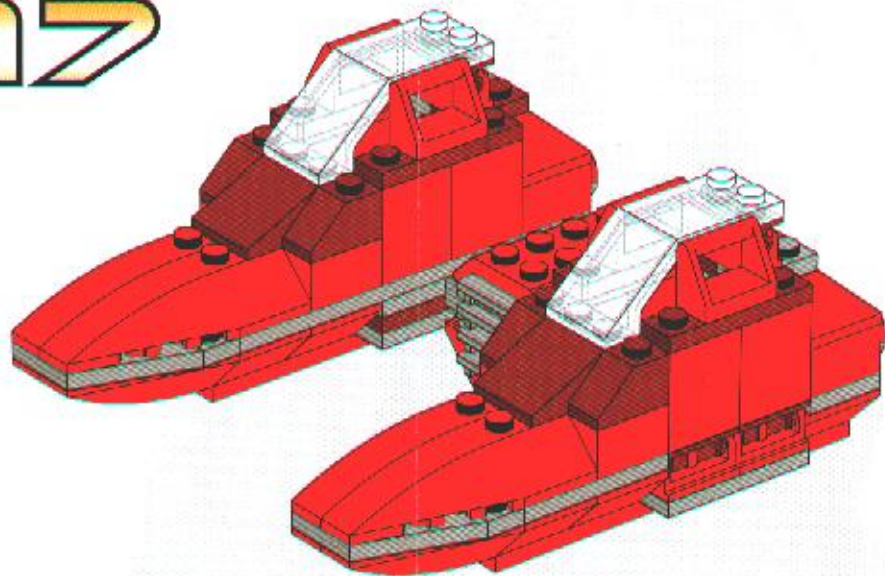

18

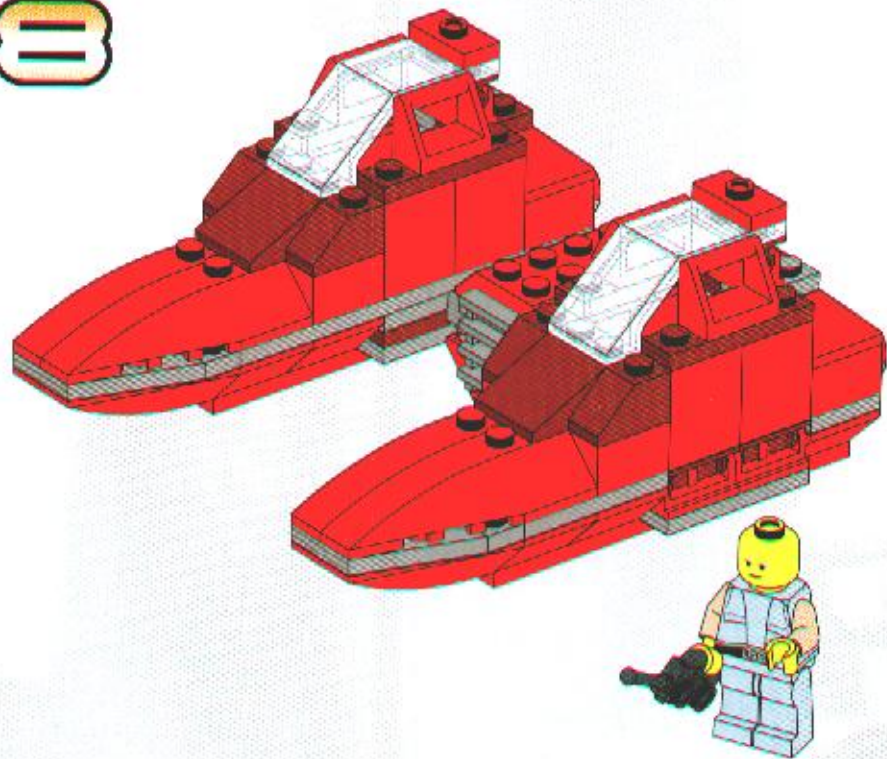



7127 ATST™

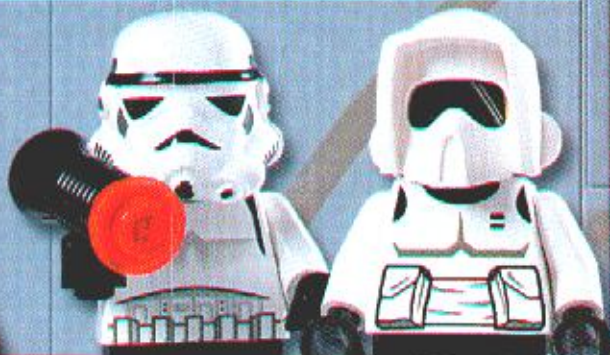

A LEGO Emperor's Shuttle is shown on a launch pad. The shuttle is white with grey and black details, and is mounted on a grey launch pad. The background shows a landscape with trees and mountains under a blue sky.

7166
Emperors Shuttle

A LEGO Twin-Pod Cloud Car is shown in a dark, rocky environment. The car is red and has two pods. The background is dark and rocky.

7119 **Twin-Pod**
Cloud Car™

A LEGO Tie Fighter is shown in a dark, rocky environment. The fighter is blue and black. The background is dark and rocky.

7146
Tie Fighter™

A LEGO Millennium Falcon is shown in a dark, rocky environment. The Falcon is white and grey. The background is dark and rocky.

7190
Millennium
Falcon™

The Final Duel

**7200
Final
Duel I**



**7201 Final
Duel II**



The Trade Federation™ Army

**7203
JEDI™ DEFENSE I**



**7204
JEDI™ DEFENSE II**



GO

www.LEGO.com

JOIN THE FUN!

STAR WARS
WWW.STARWARS.COM



©LEGO, the LEGO logo, the JUST IMAGINE logo and the Minifigure are trademarks of
their respective owners and are used under license from the LEGO Group.
©2002 The LEGO Group.

©2002 Lucasfilm Ltd. & TMPC. All rights reserved. Used under authorization. / Tous droits
réservés. Utilisé sous autorisation. / Todos los derechos reservados. Usado bajo autorización.

