

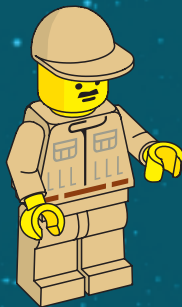

7134

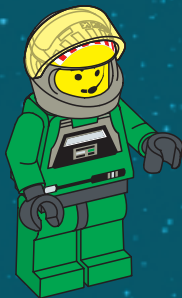

A-WING FIGHTER™

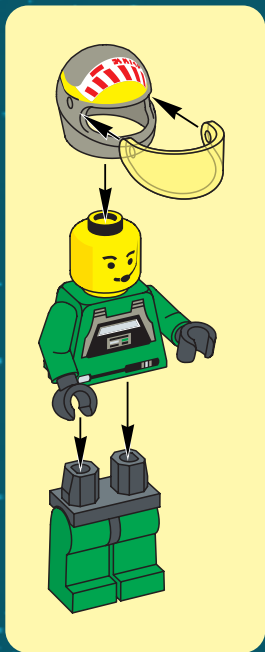



1

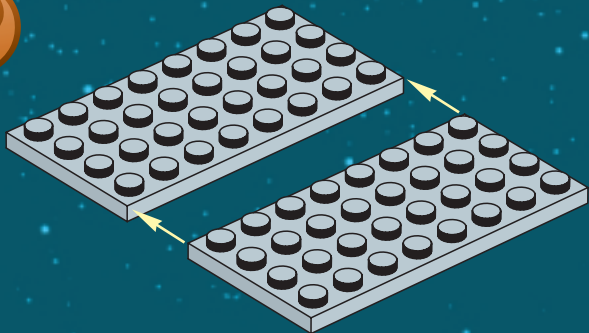

2





3

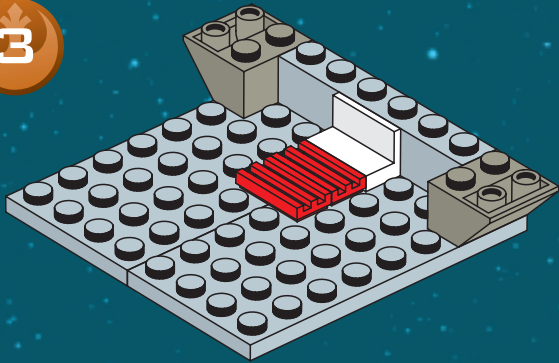

4

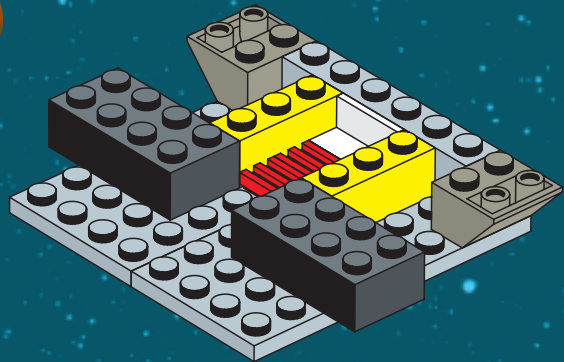



5

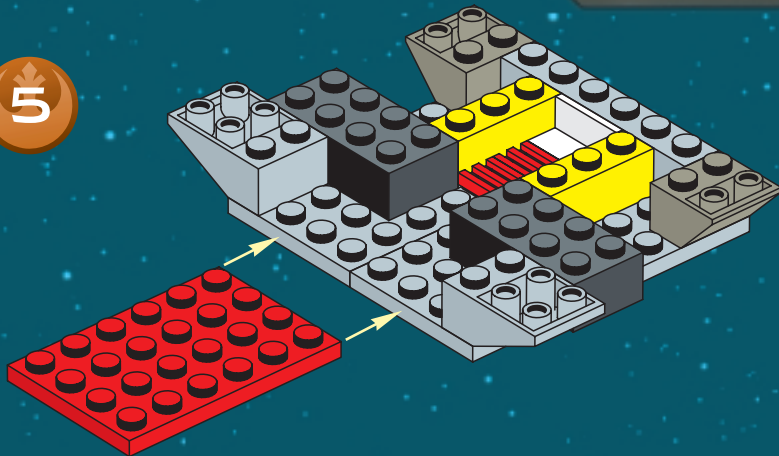

6

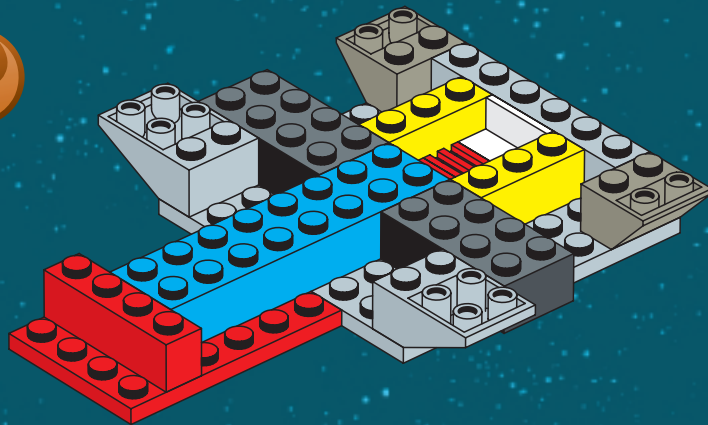



7

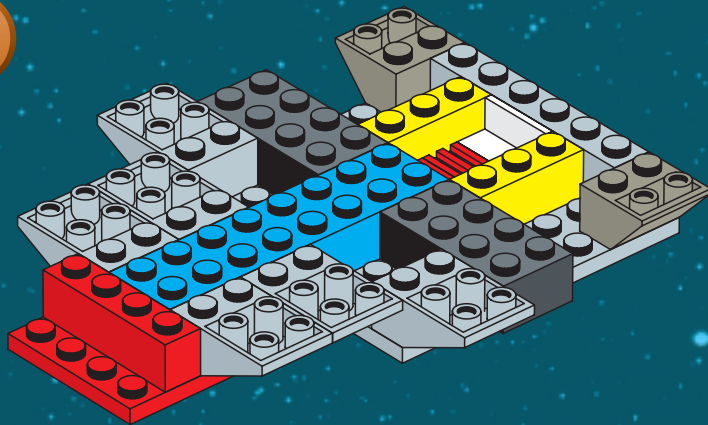



8

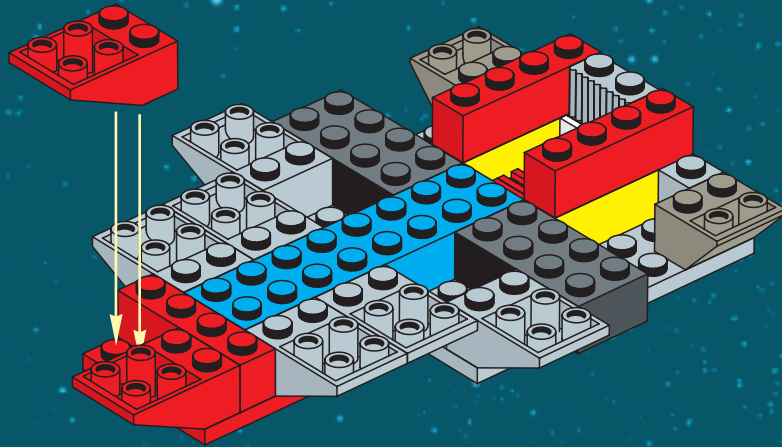

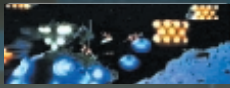

1

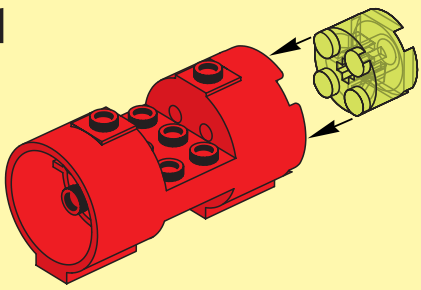

2

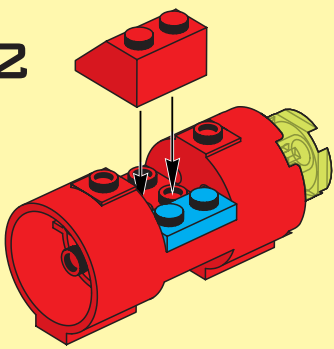

9

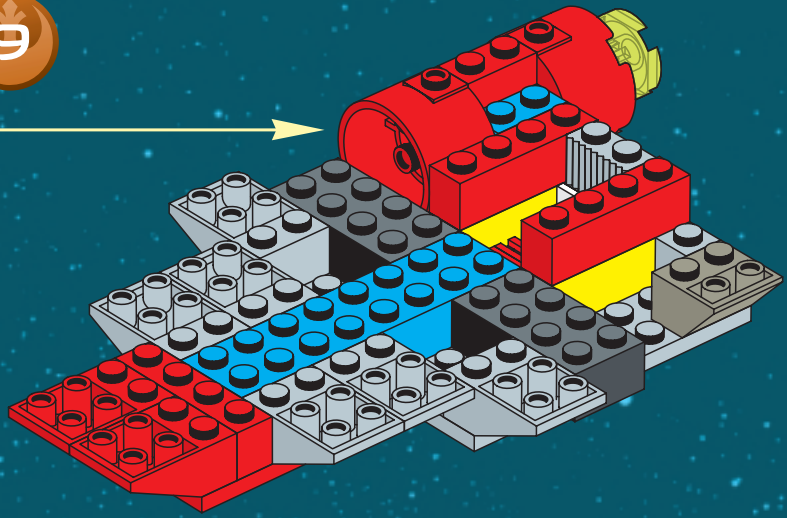



1

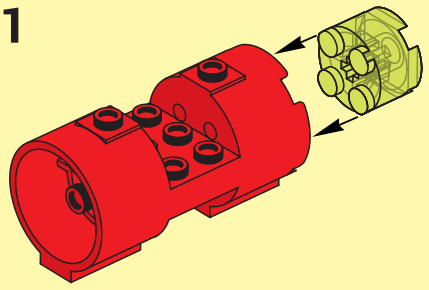

2

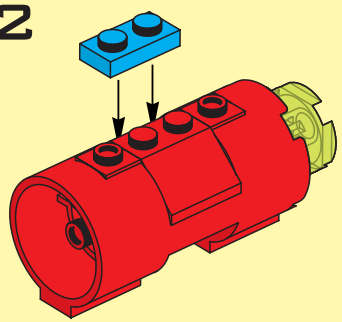

10

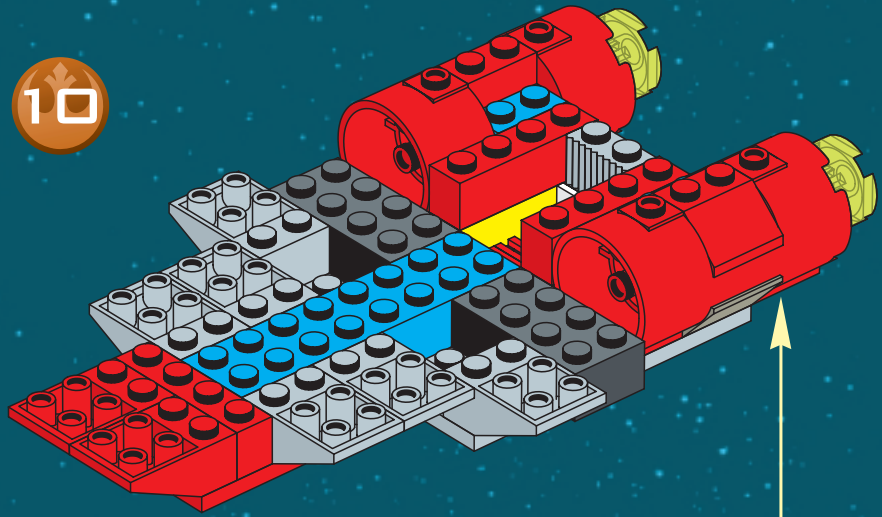



11

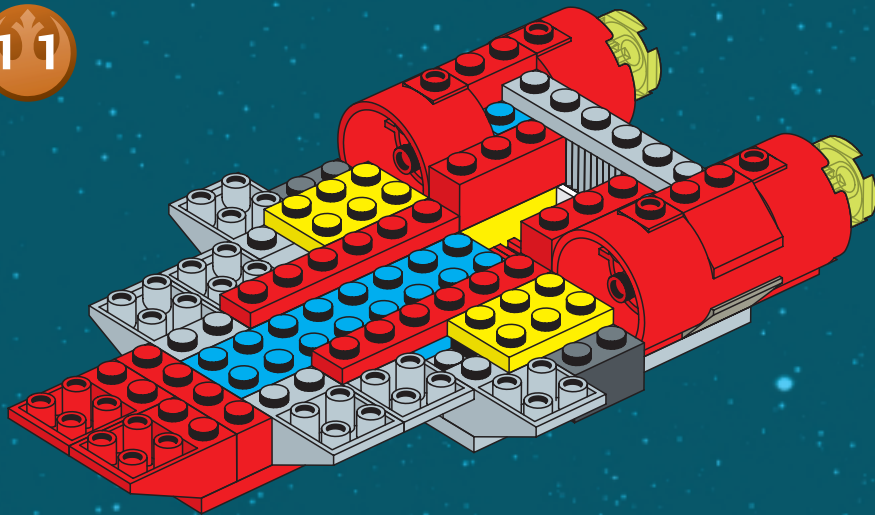



12

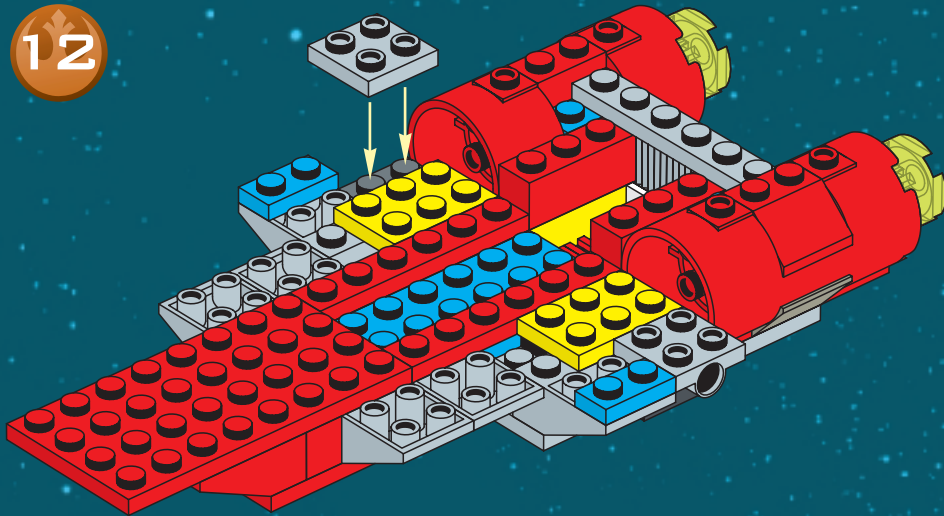



13

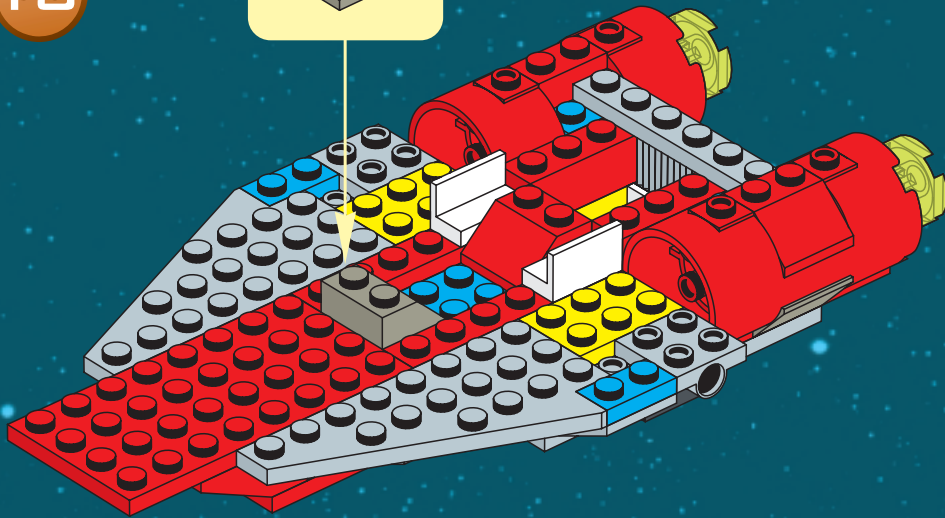
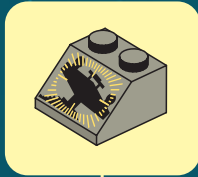



14

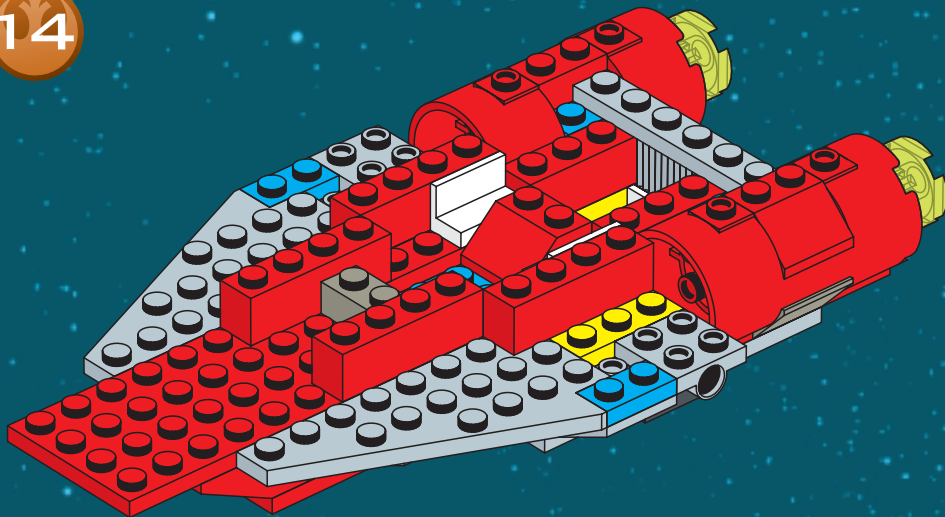



15

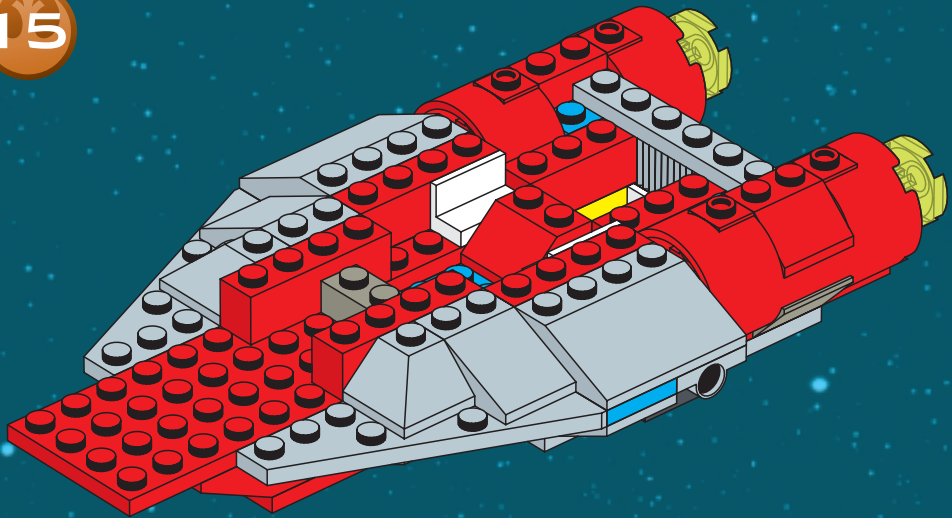

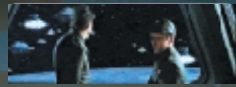

16

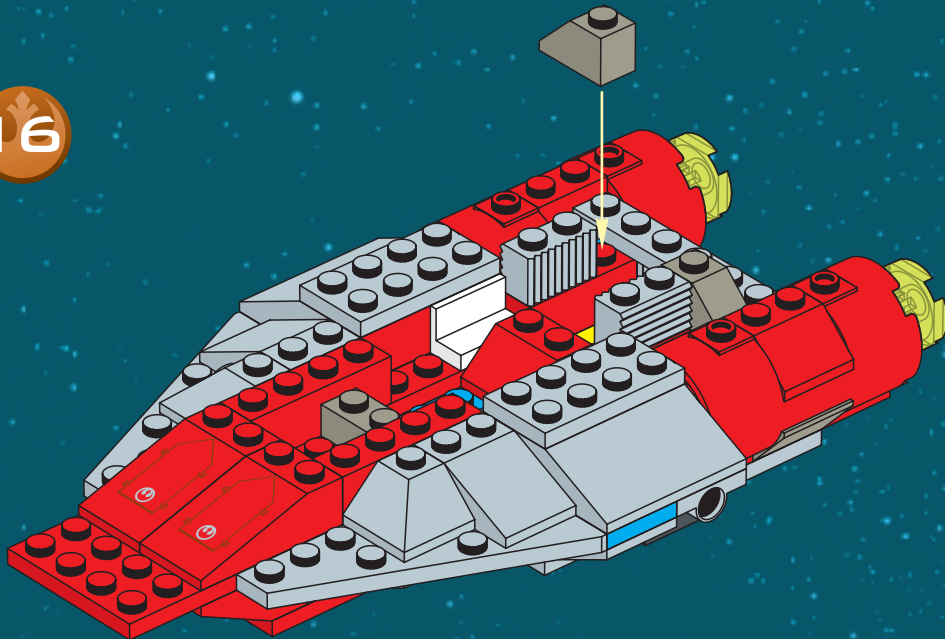

17

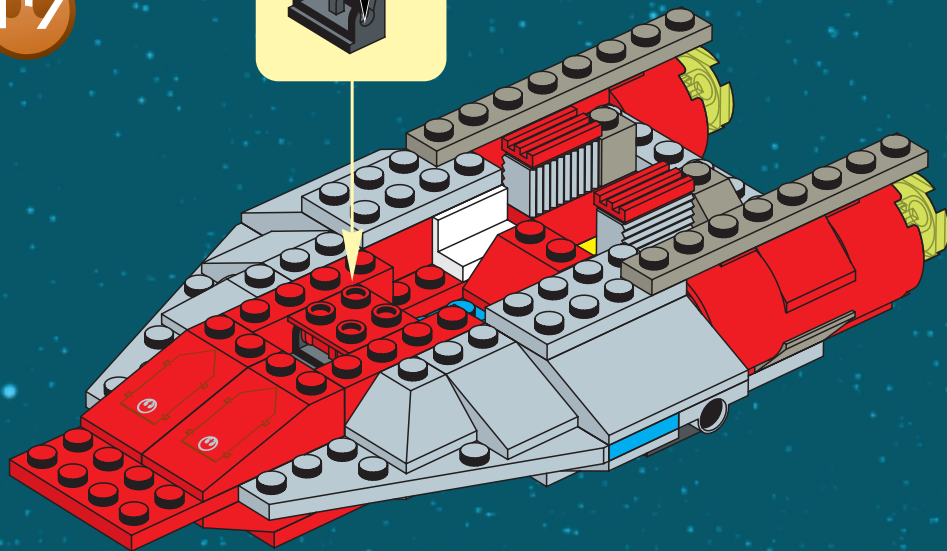
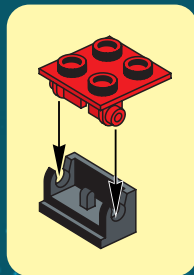



1

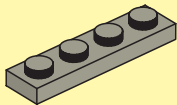

2

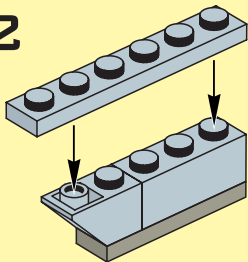

3

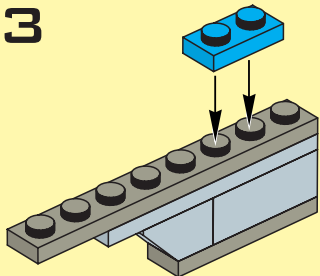

2x

18

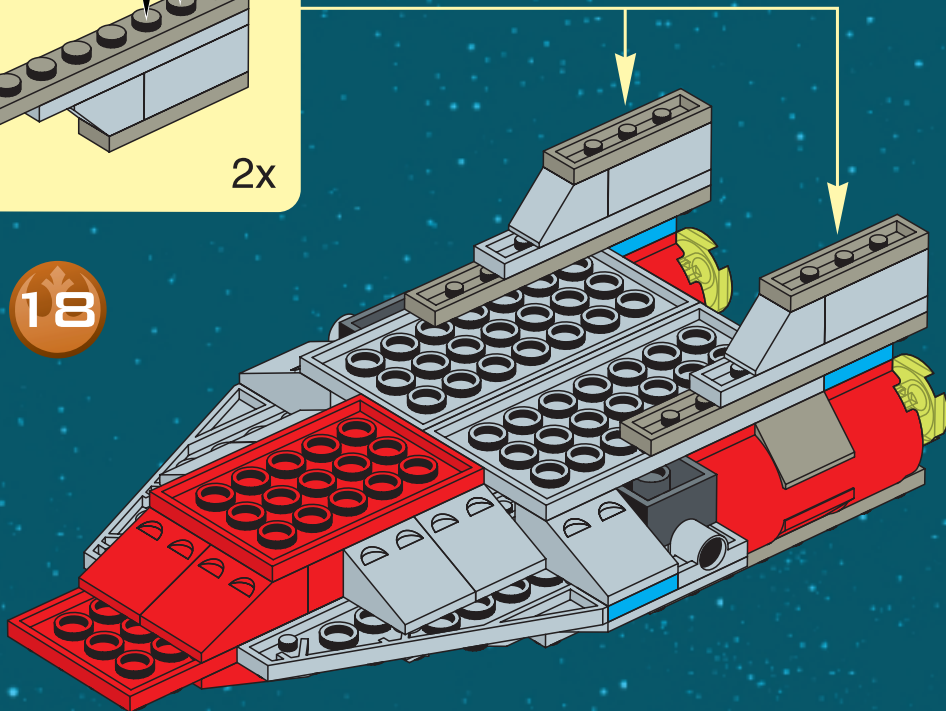



19

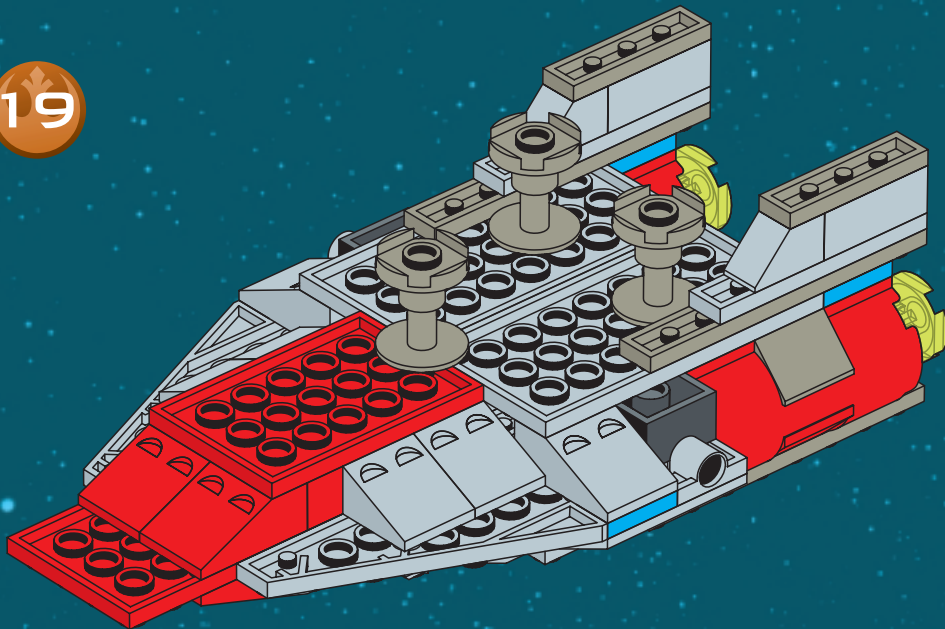



20

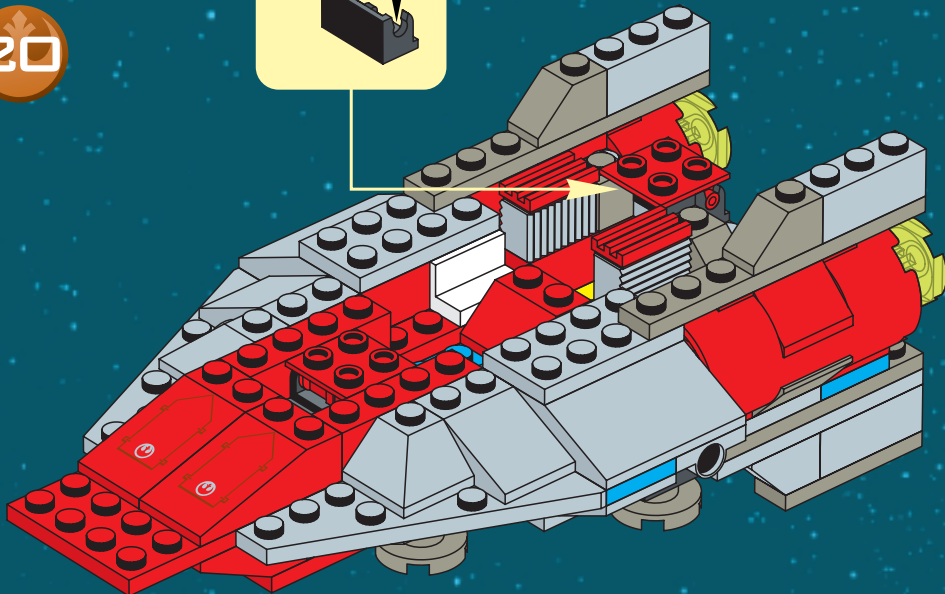
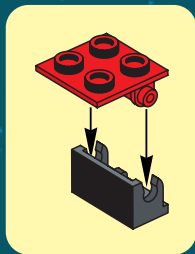



21

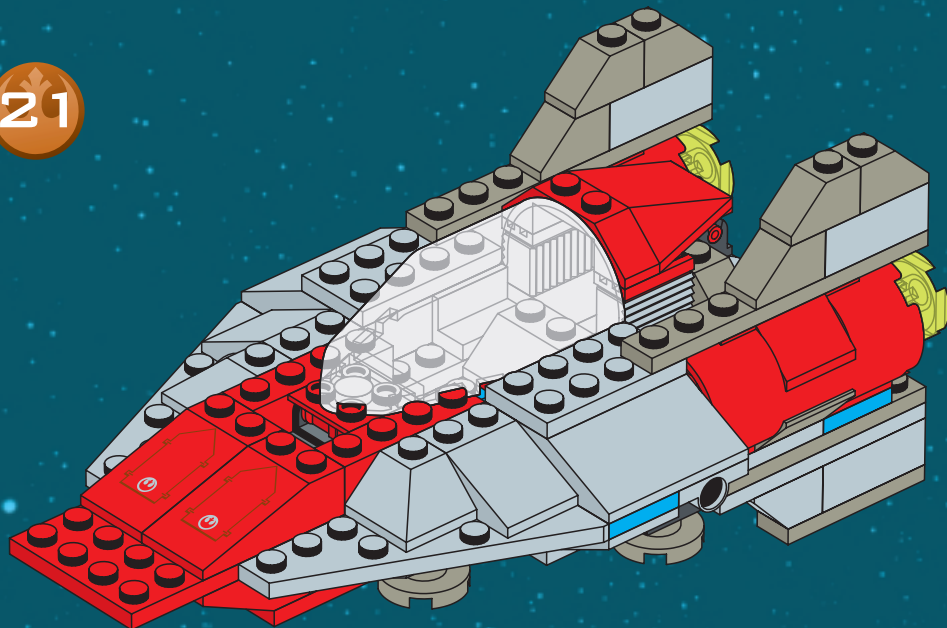



1

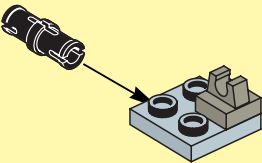

2

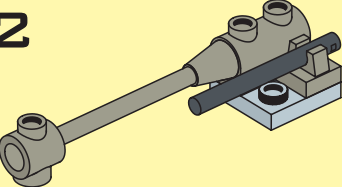

22

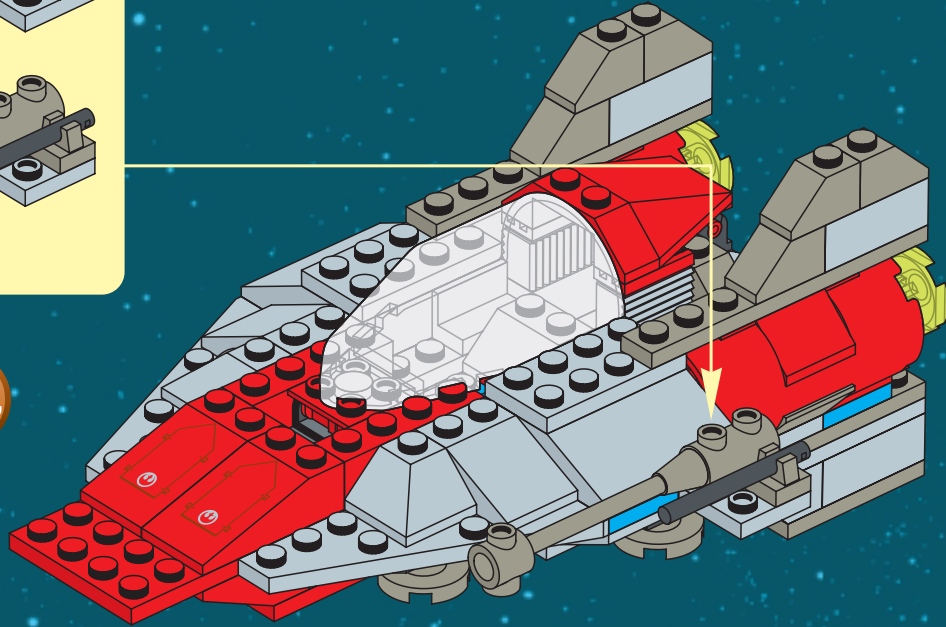



1

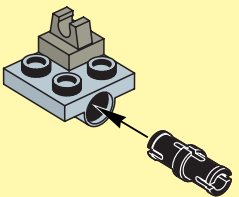

2

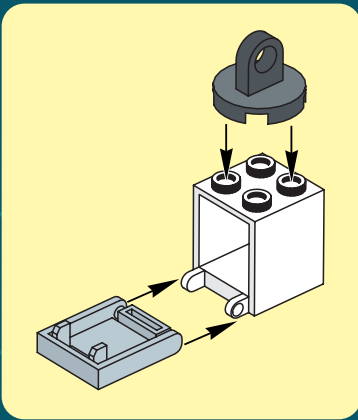
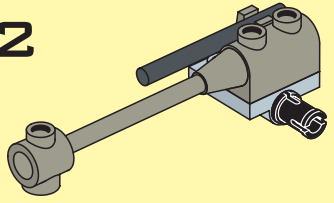

23

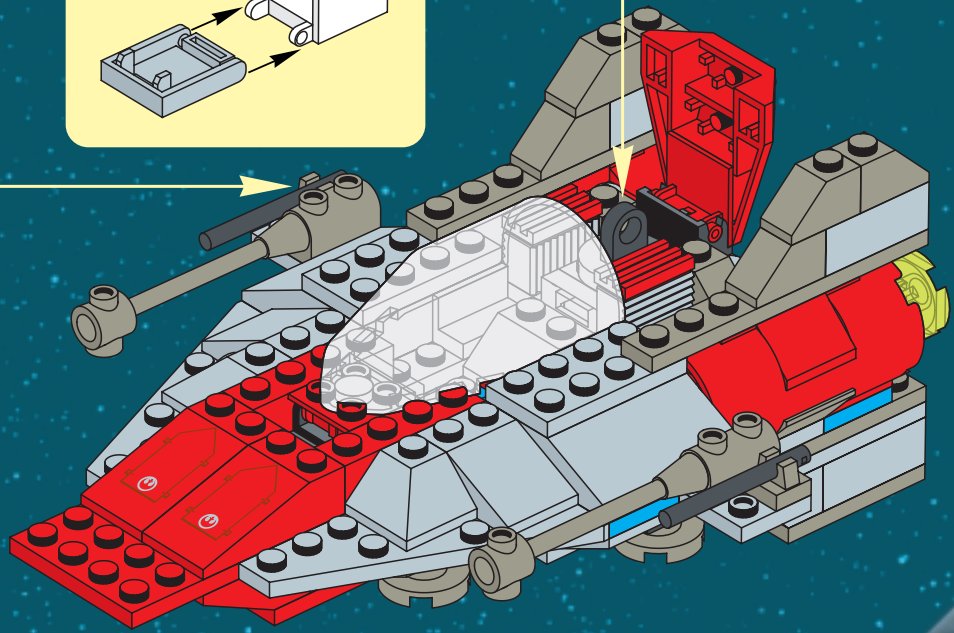



24

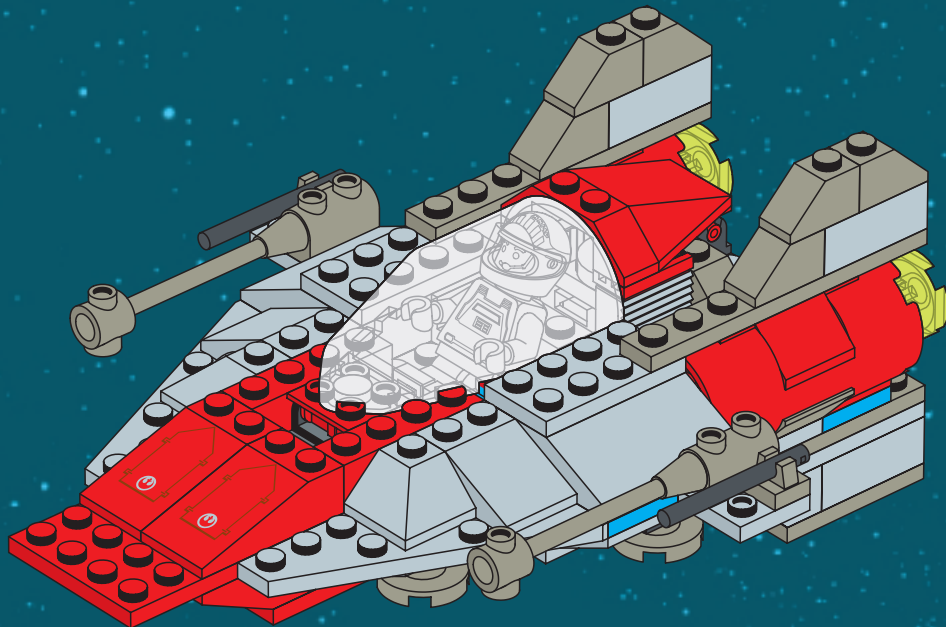

www.LEGO.com

©2000LEGO Group.
©The LEGO Group. The LEGO SYSTEM logo and the minifigure are trademarks of the LEGO Group.

© Lucasfilm Ltd. & TM. All rights reserved.
All *Star Wars* elements are property of
Lucasfilm Ltd. and/or Lucas Licensing Ltd.

Official *Star Wars* Web Site
<http://www.starwars.com>

