

LEGO

**STAR
WARS**

7255

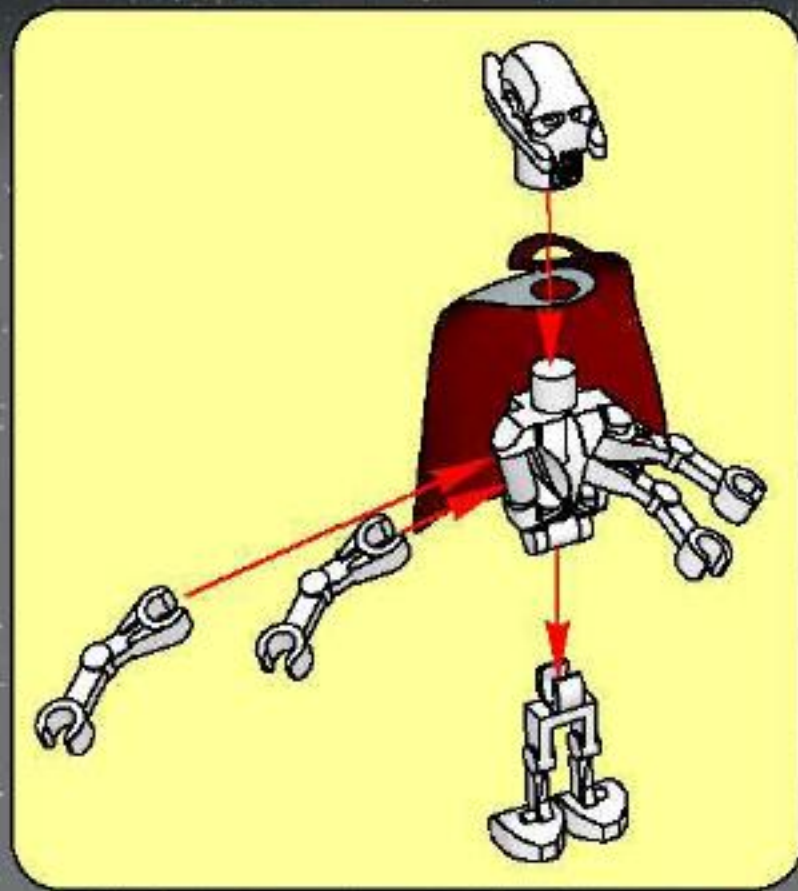

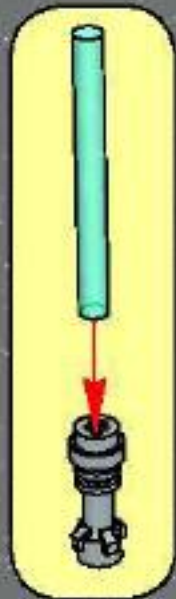
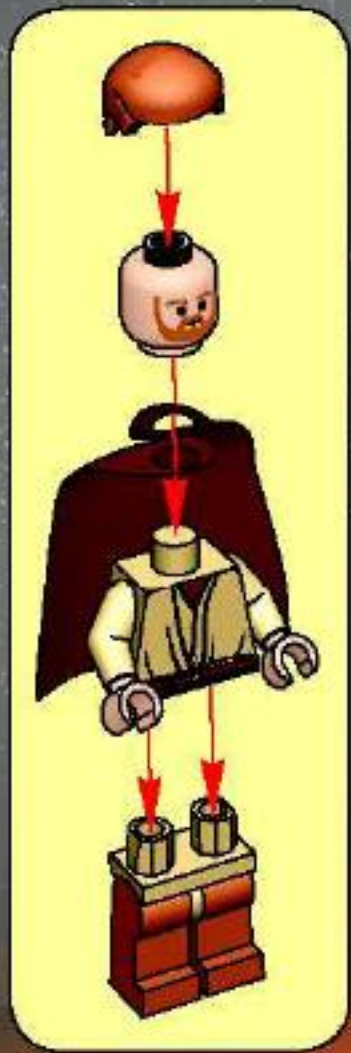



1



2



3



4



5



1

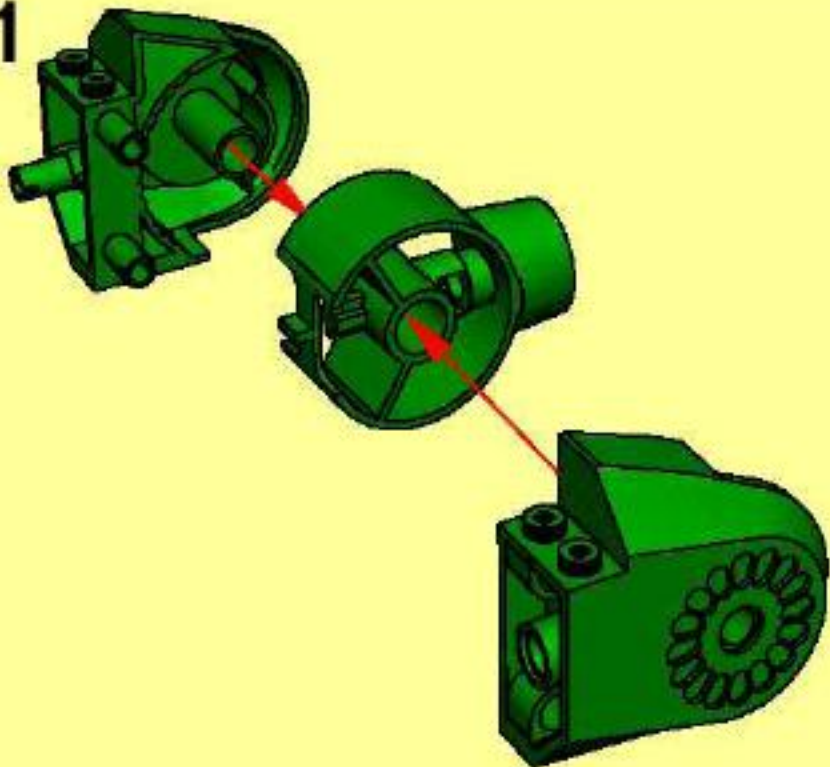

2

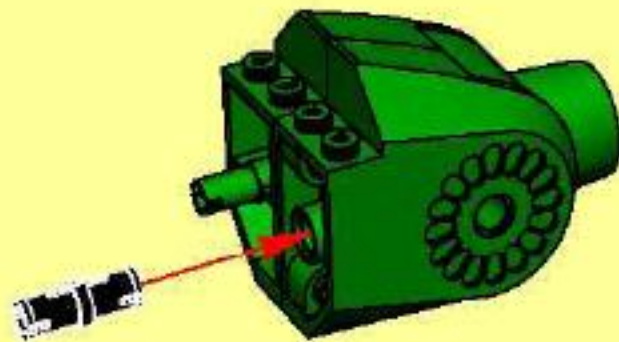

2x

6

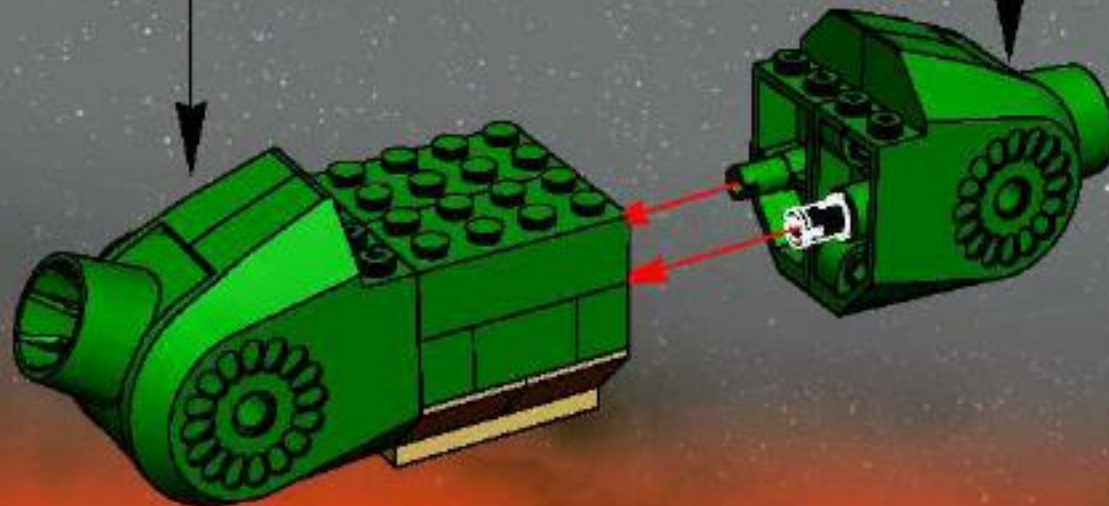

7

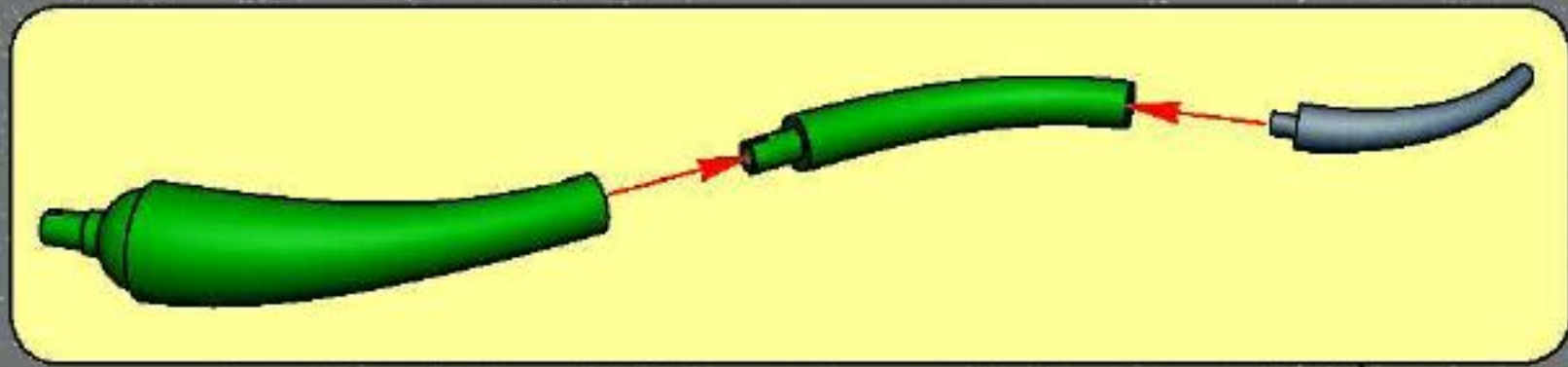
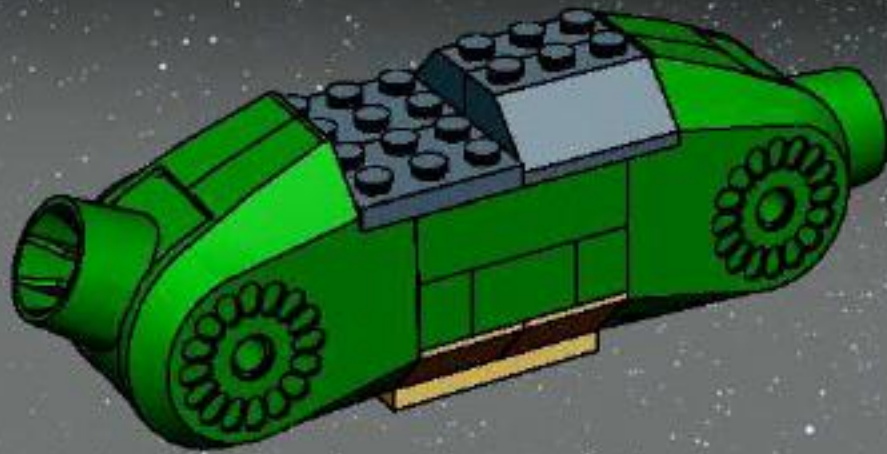

8

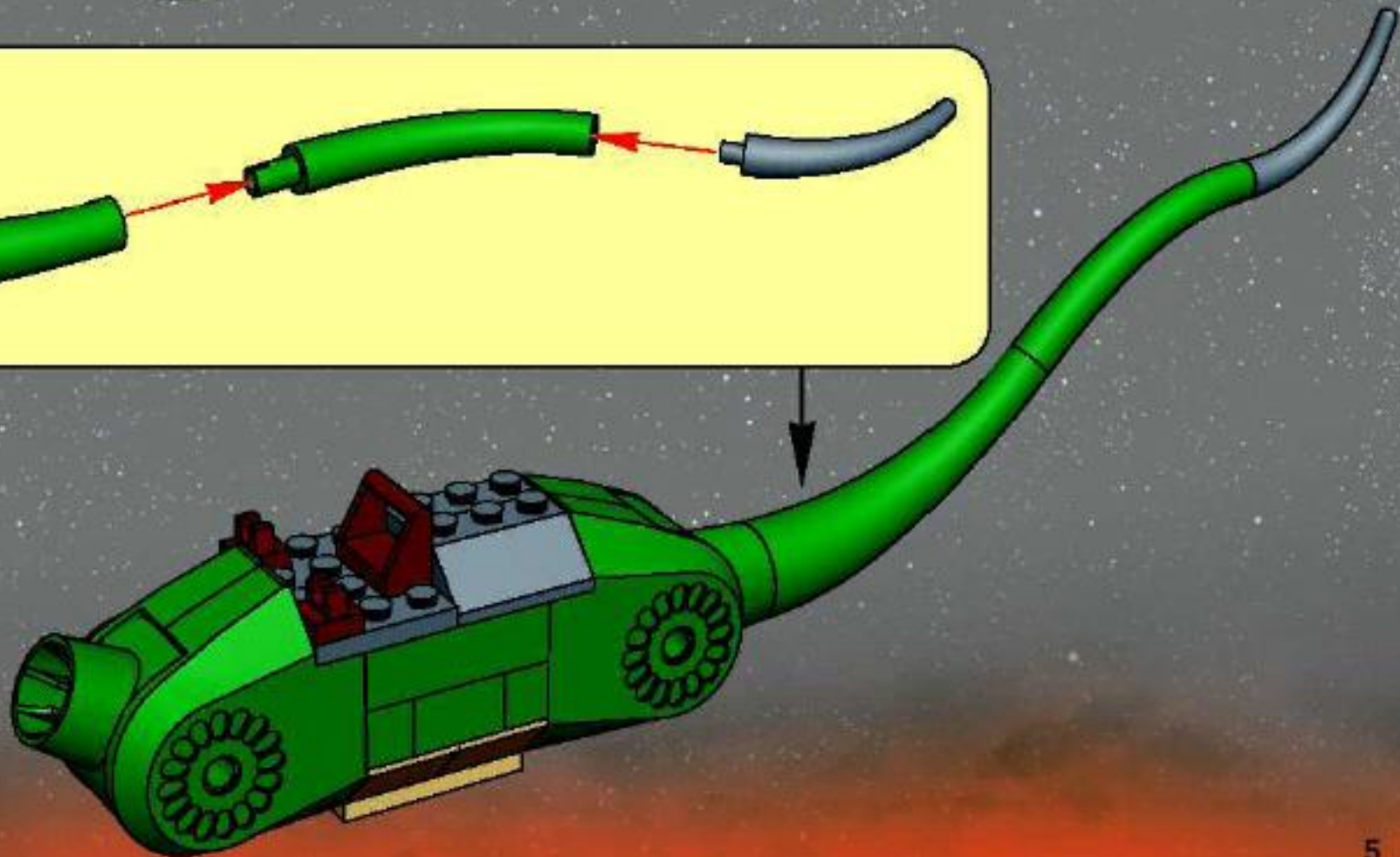

9

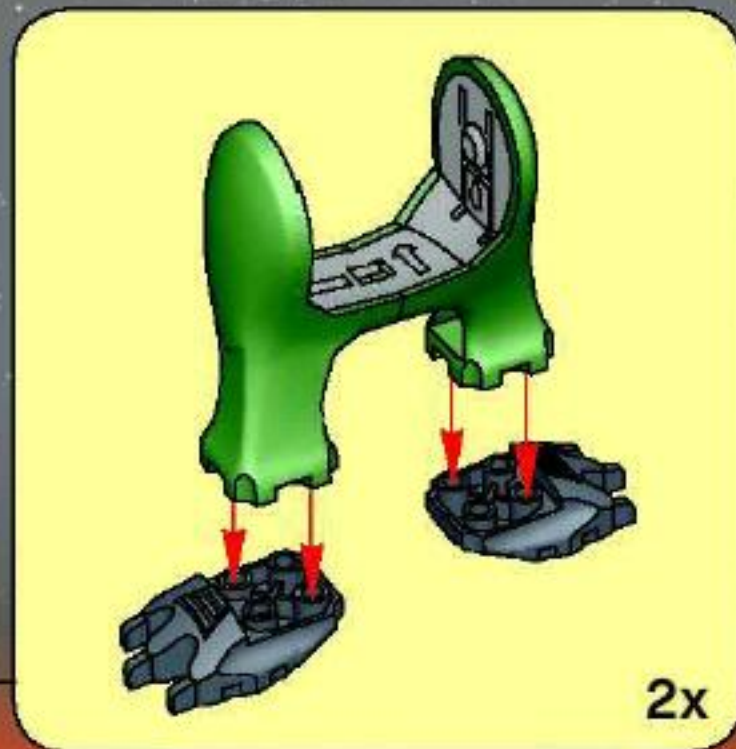
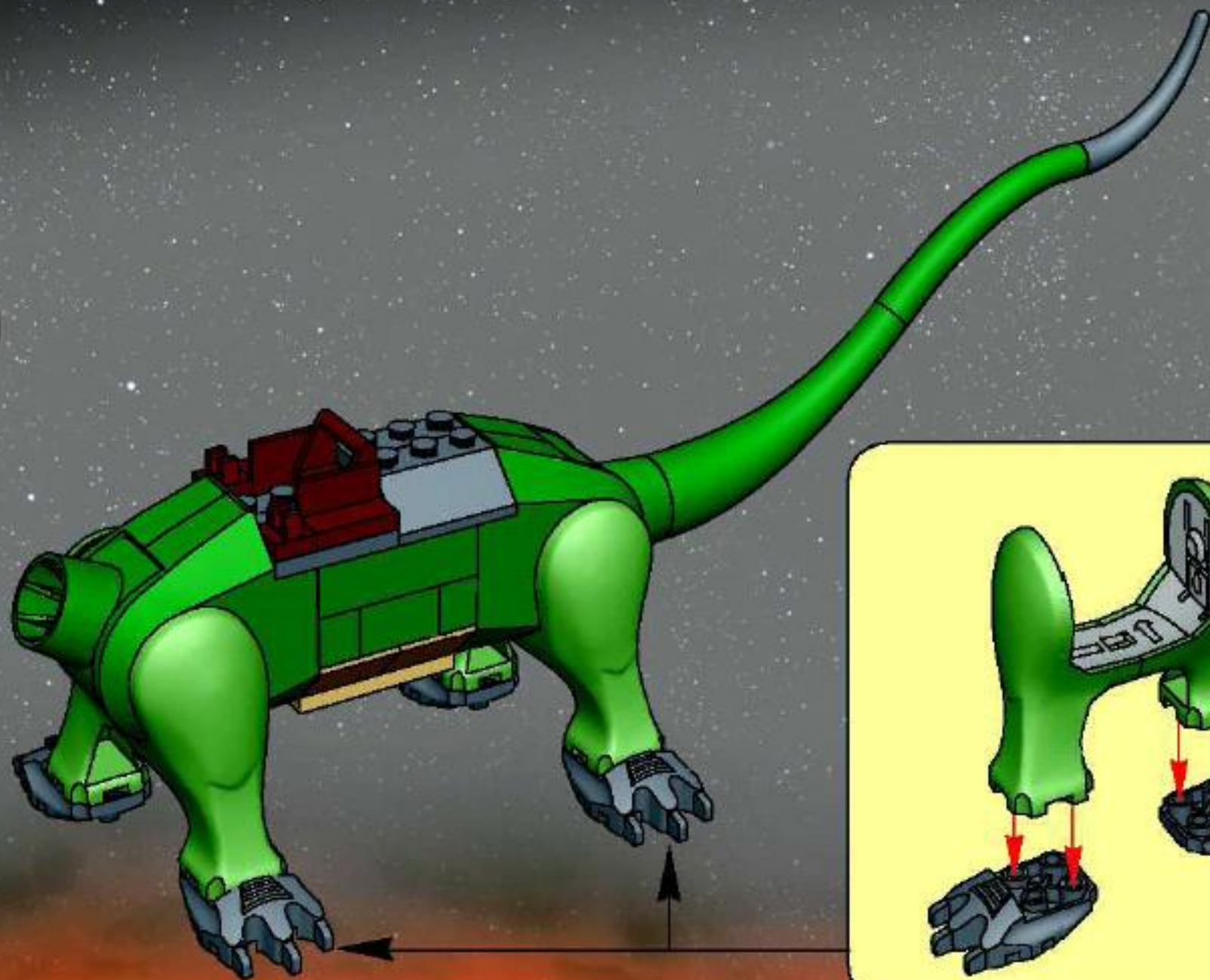

1

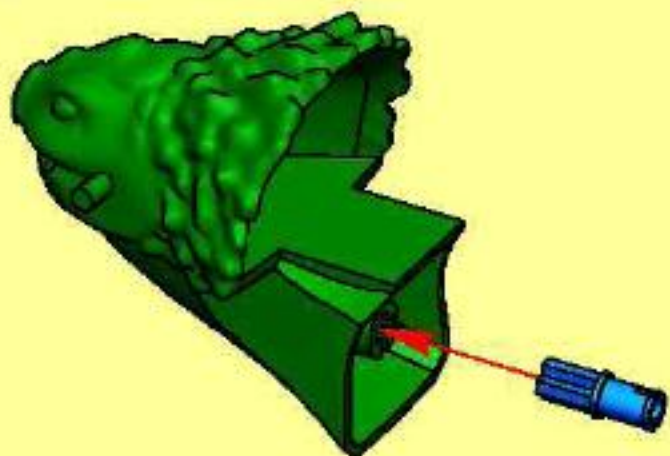

2

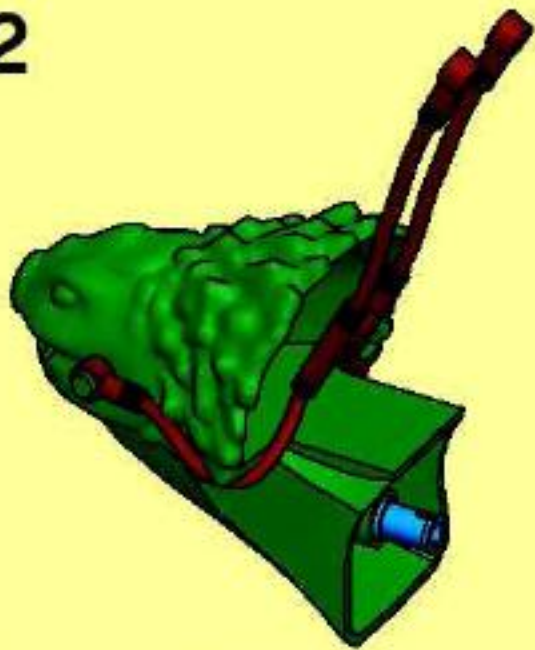

10

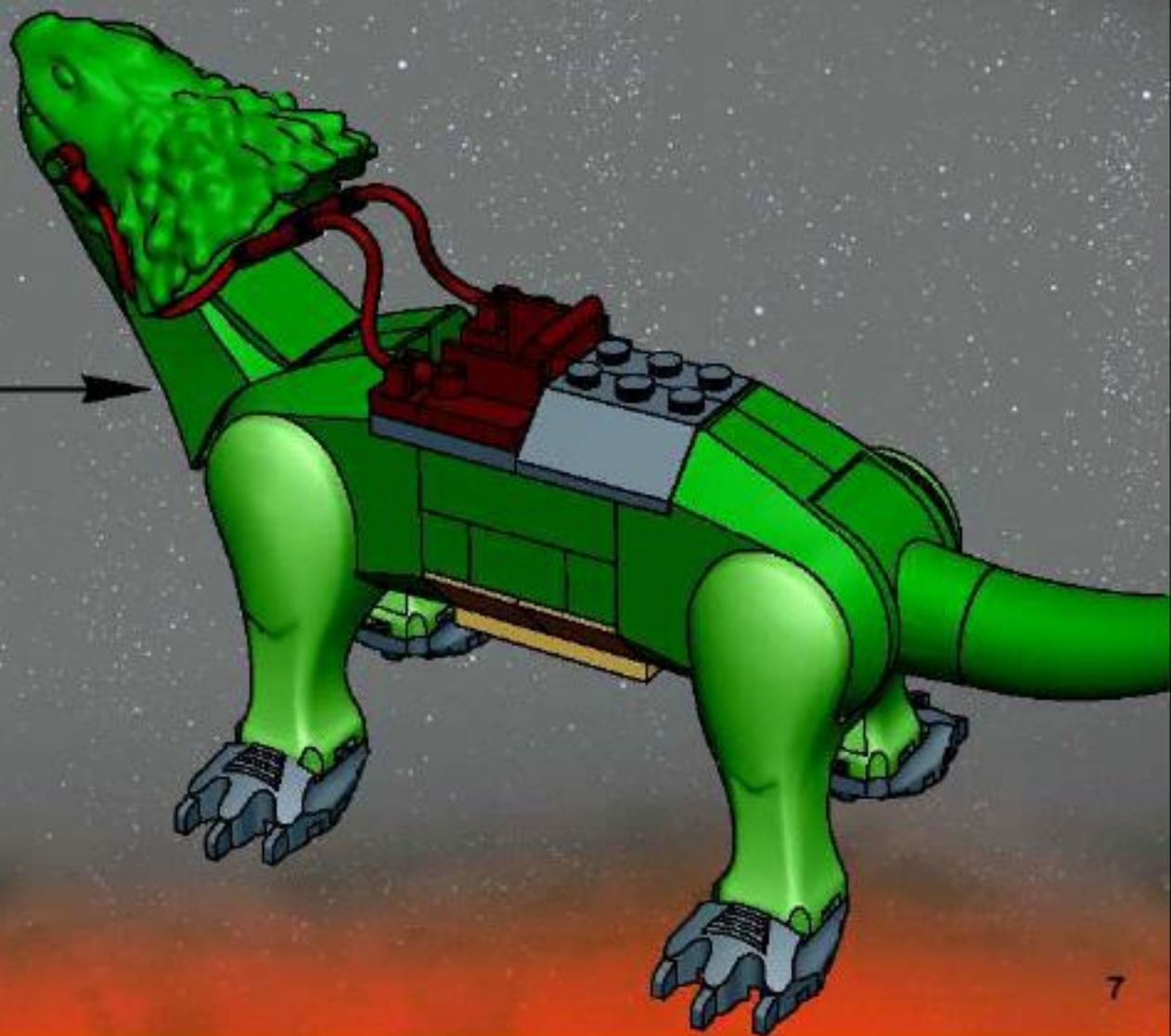

11



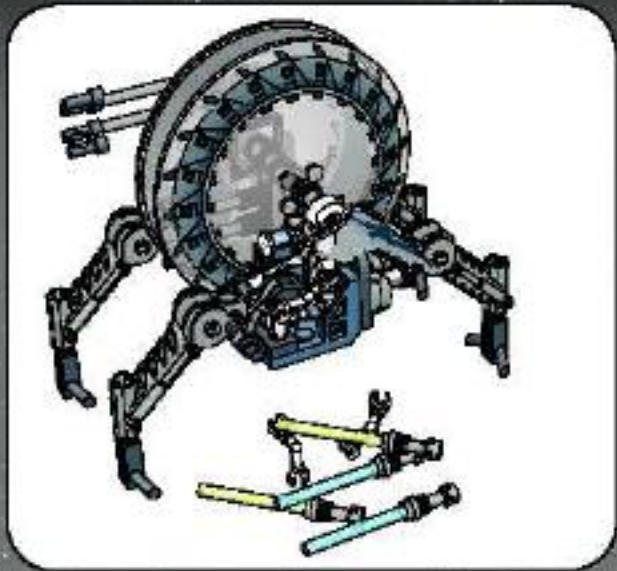

1



2

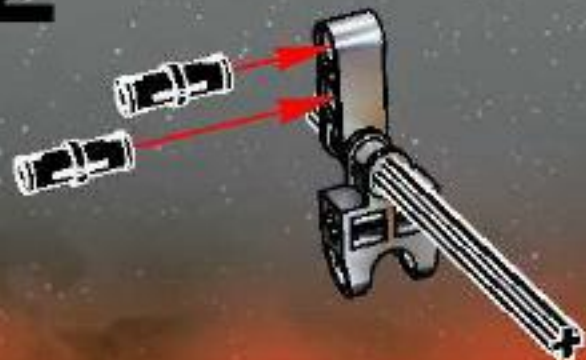

3

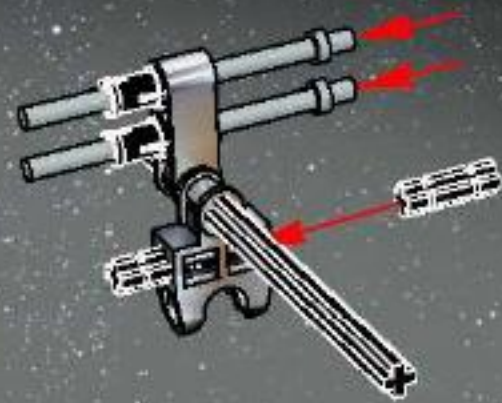

4

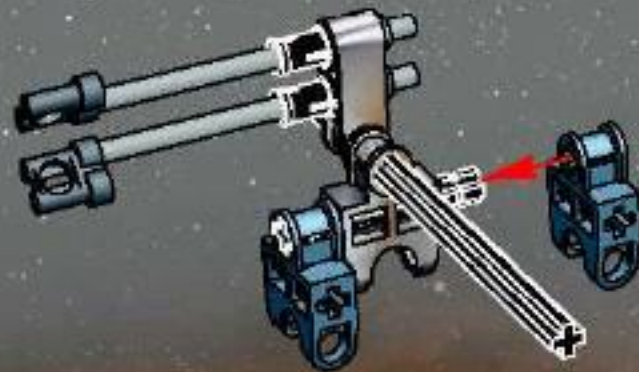

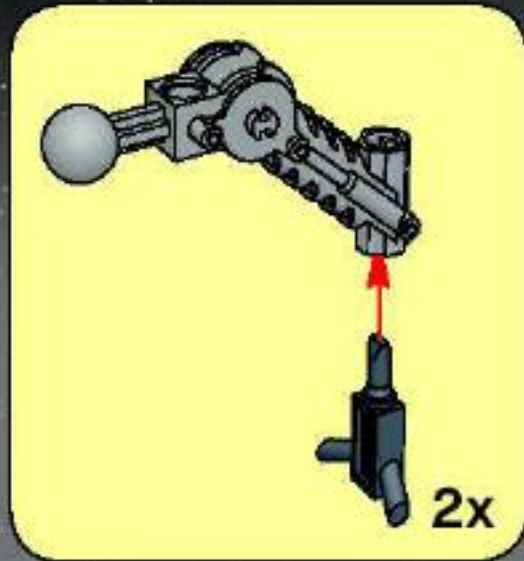

5

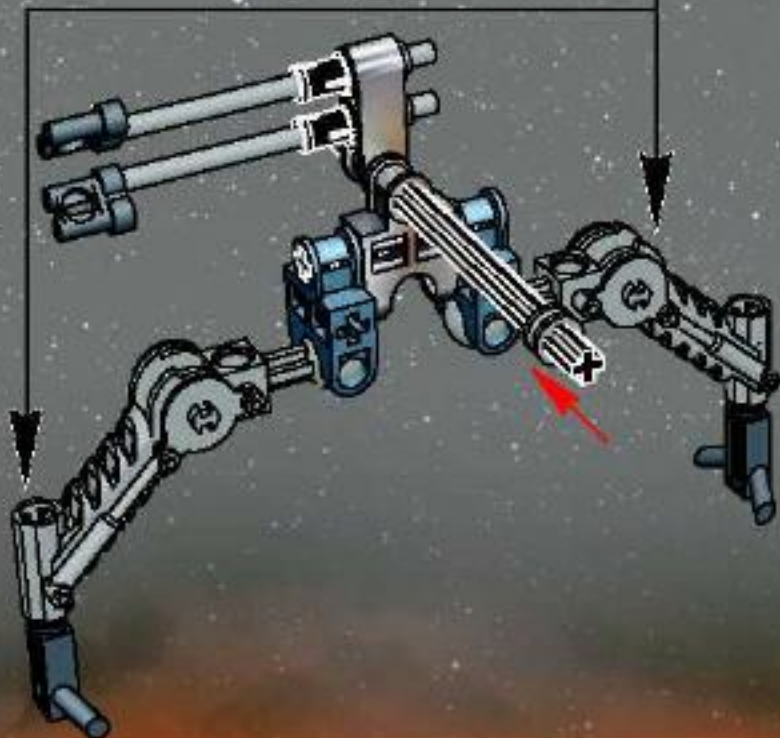

6

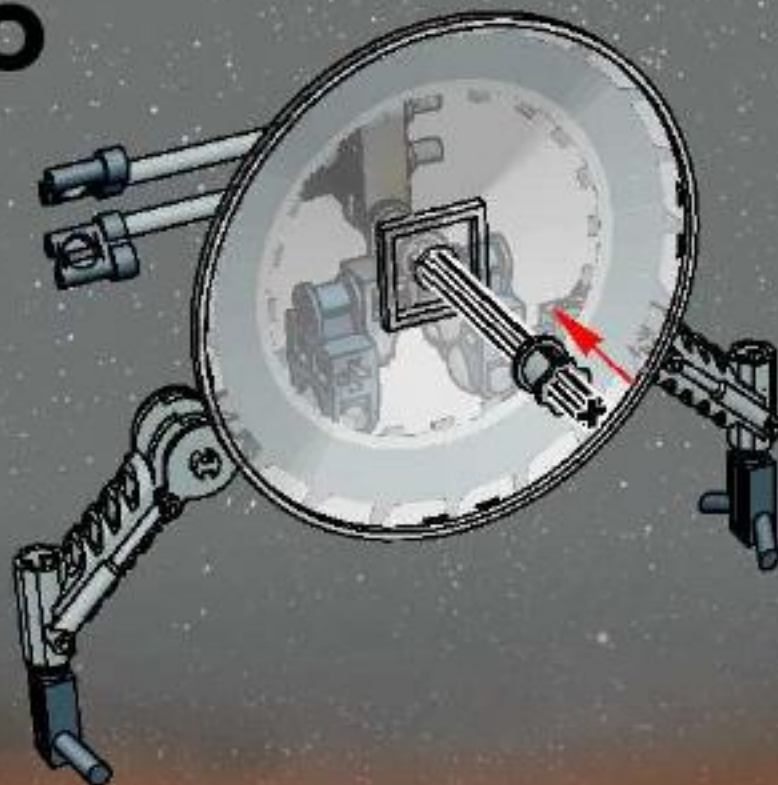

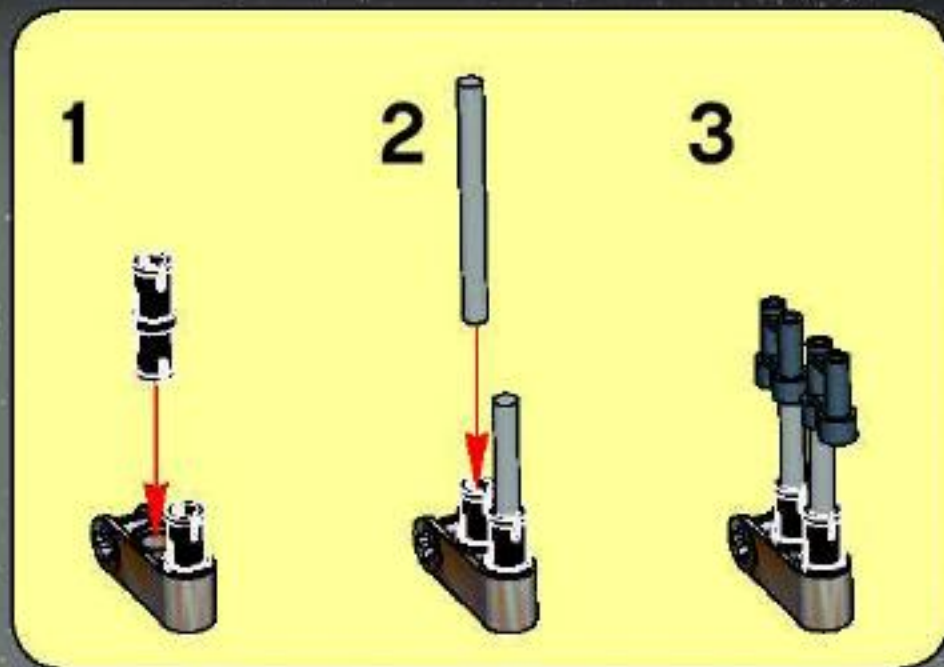

7

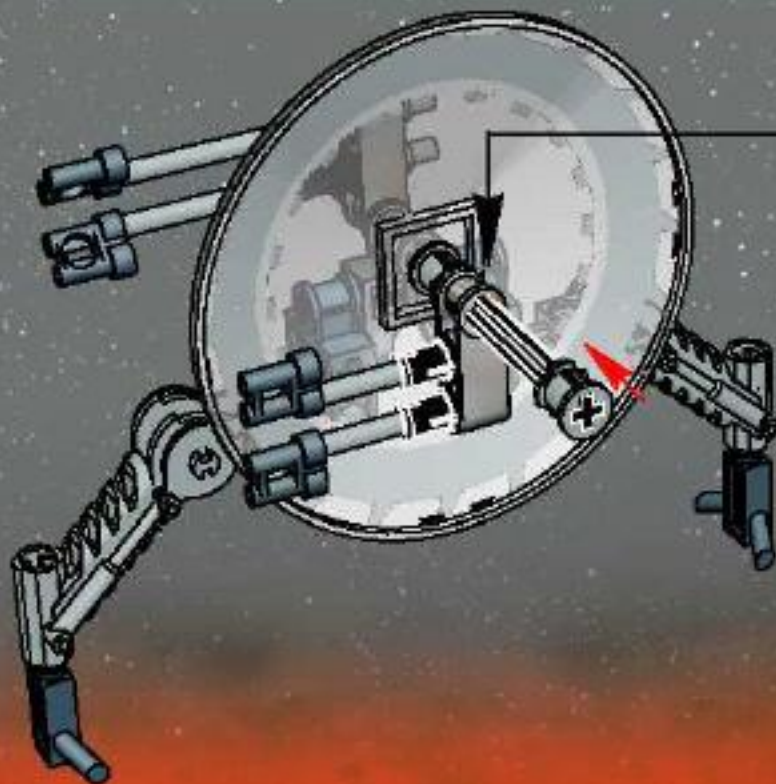

8

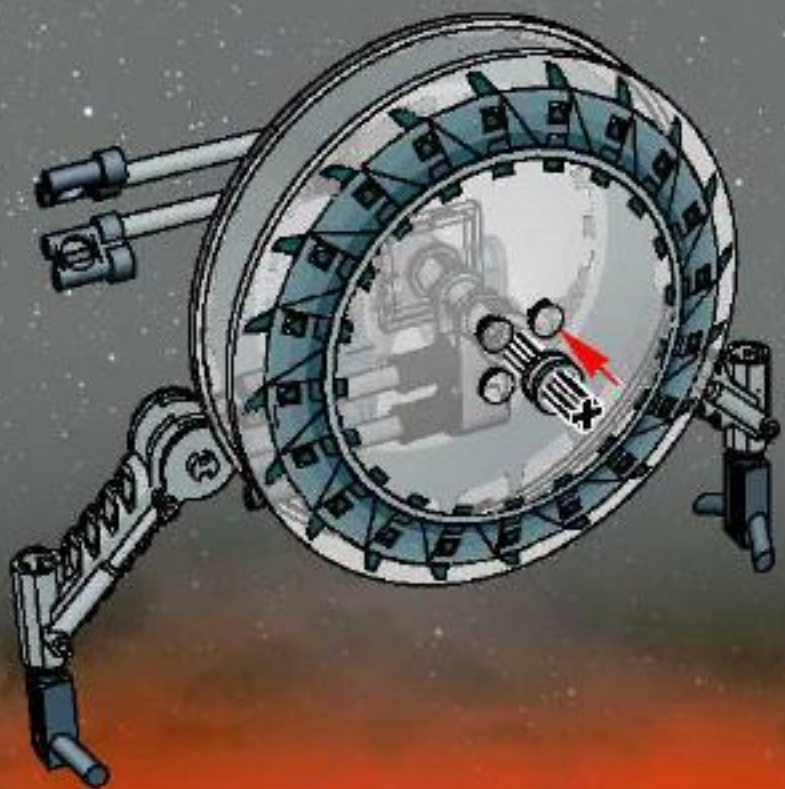

9

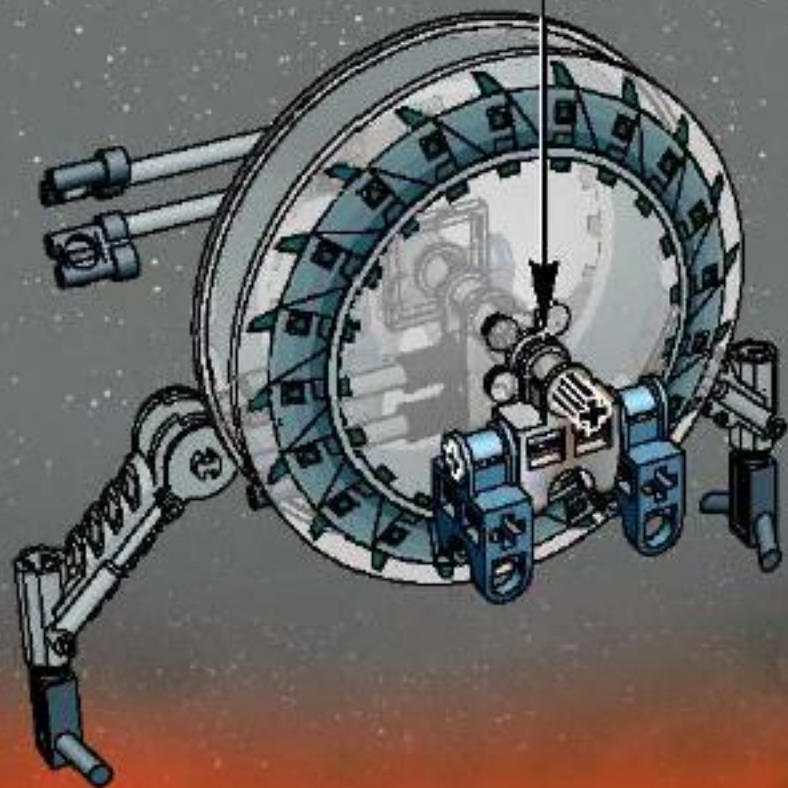

1

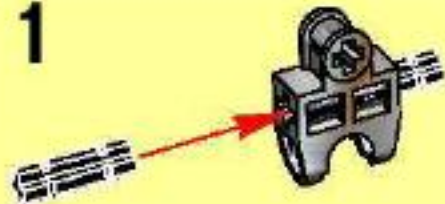

2

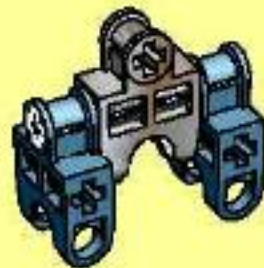

10

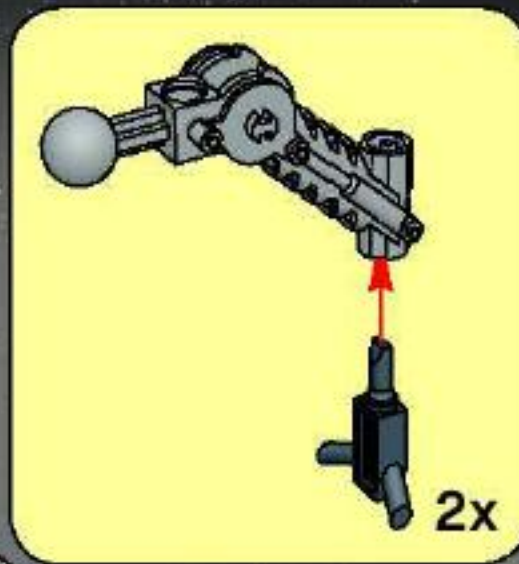
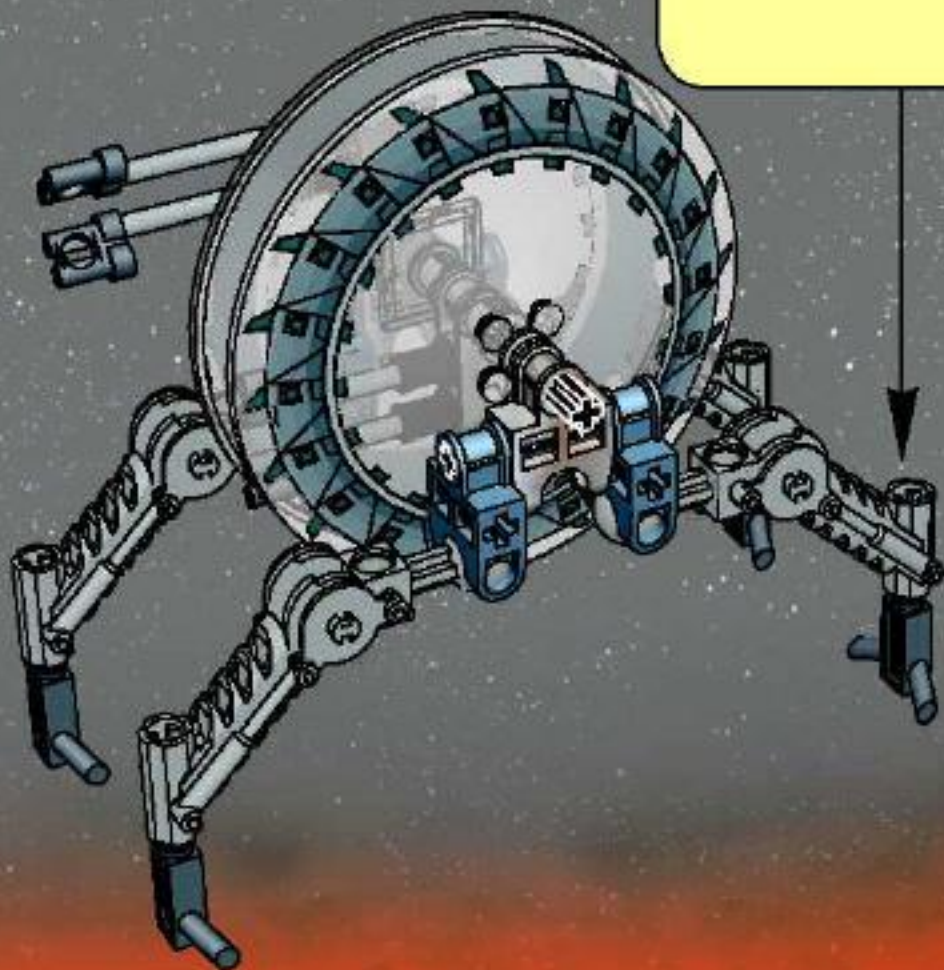

1



2

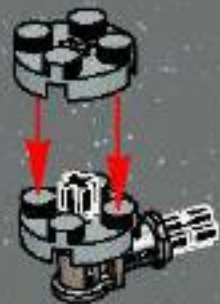

3



4



5



6



11

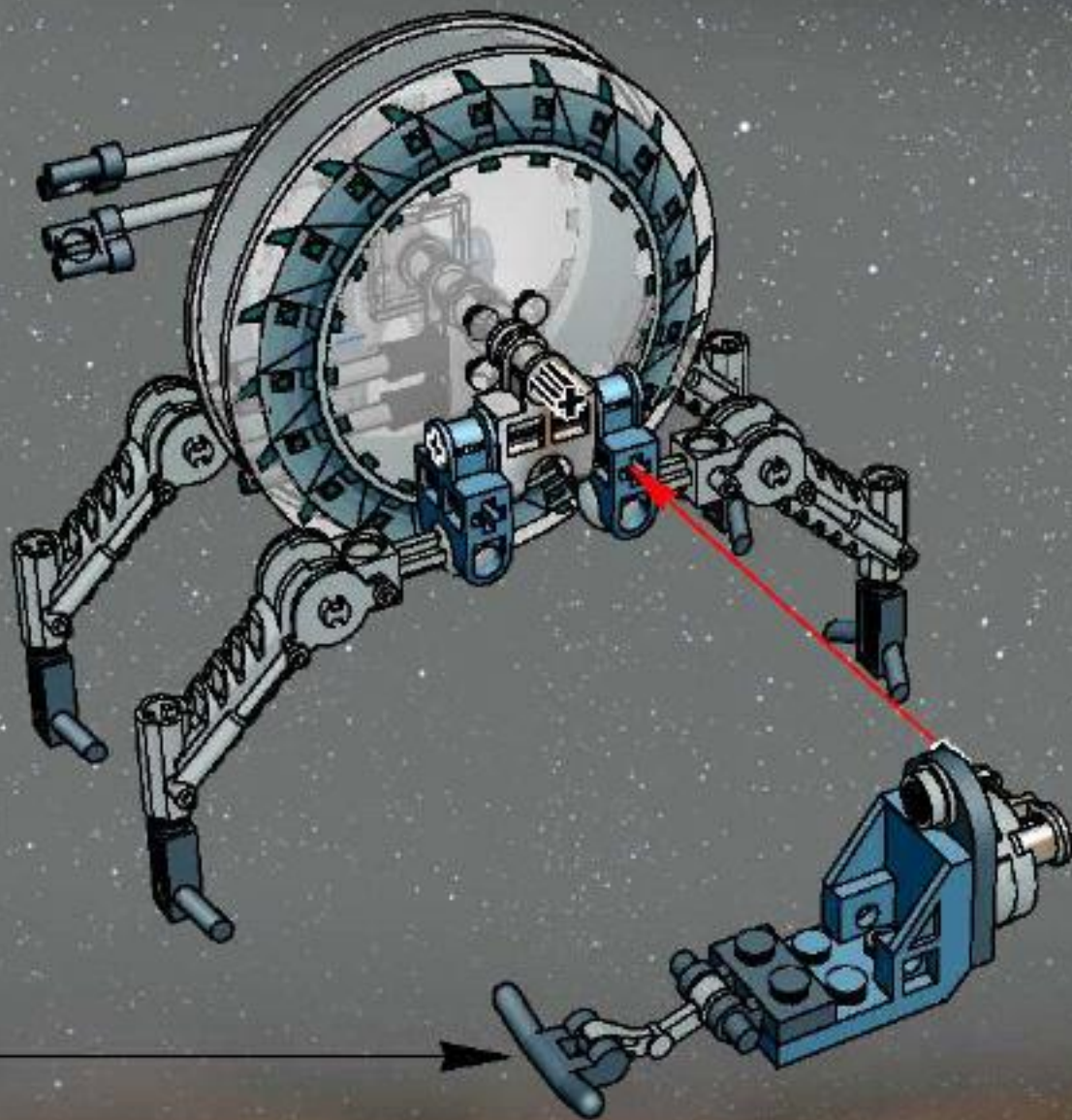

12

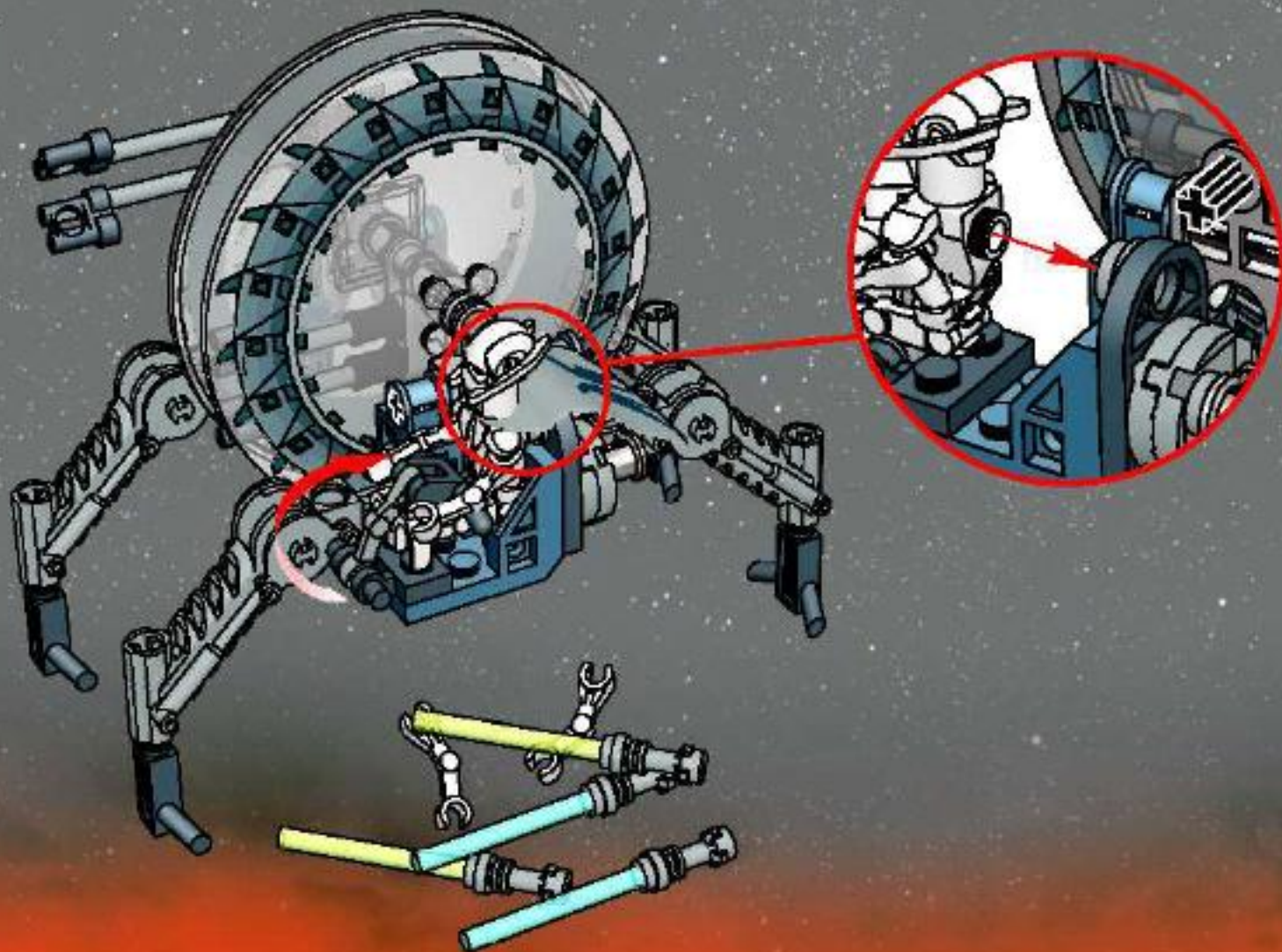

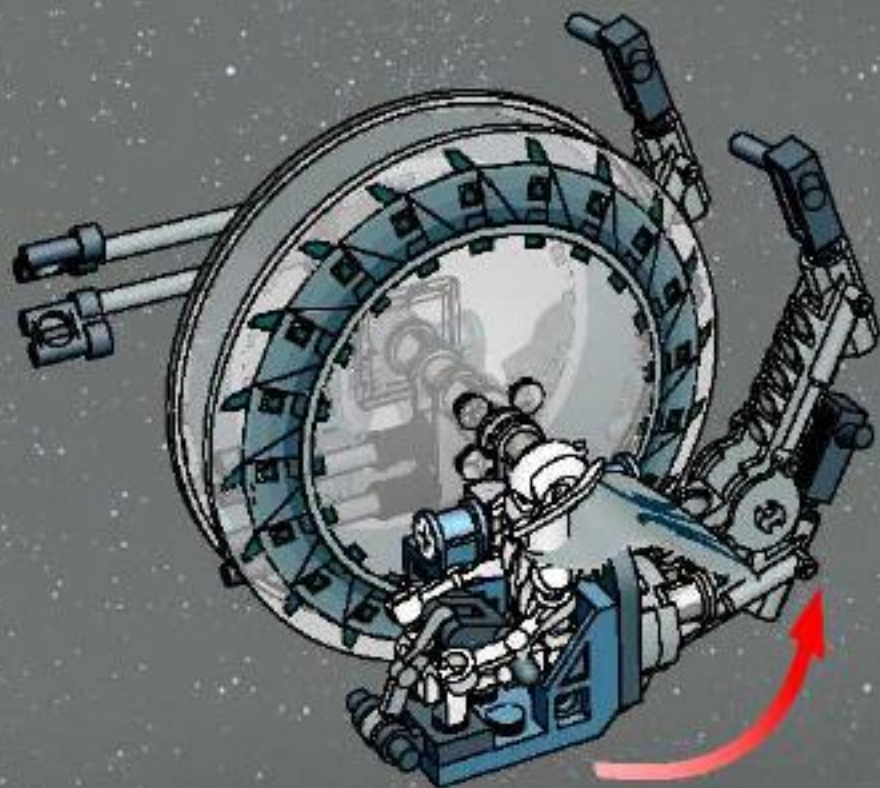
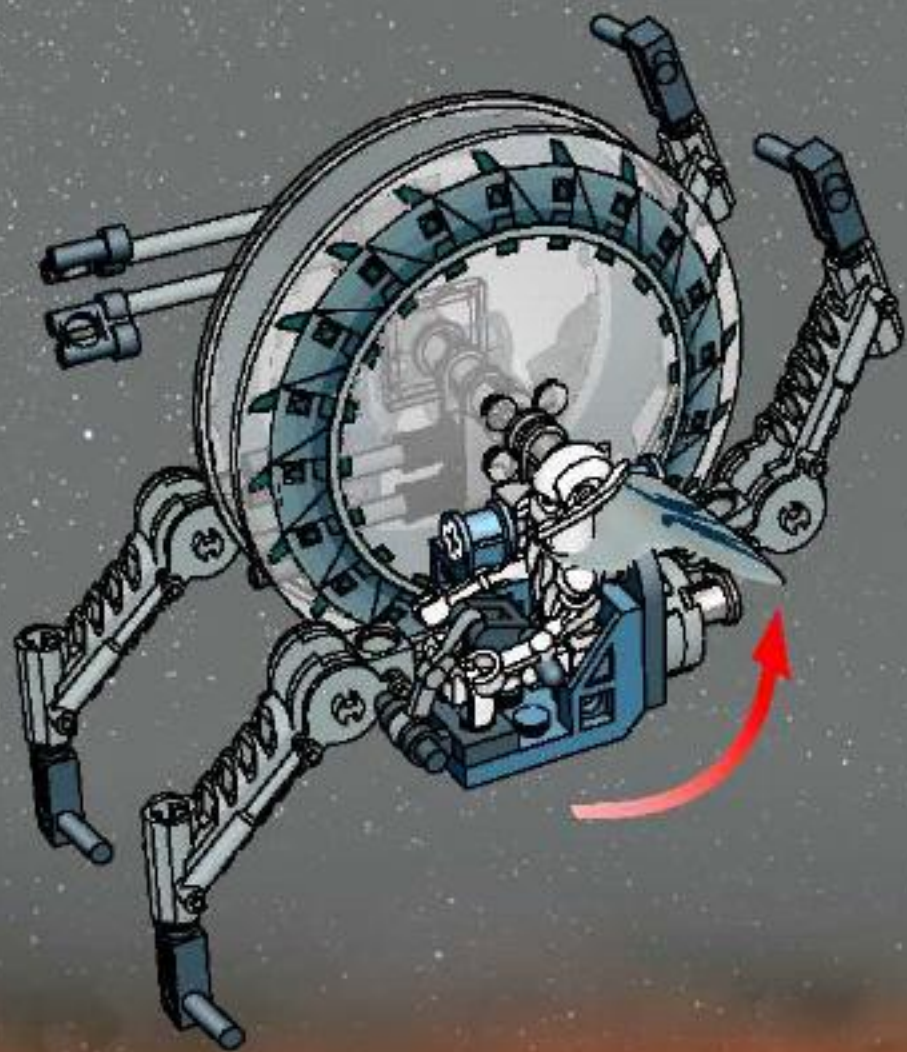

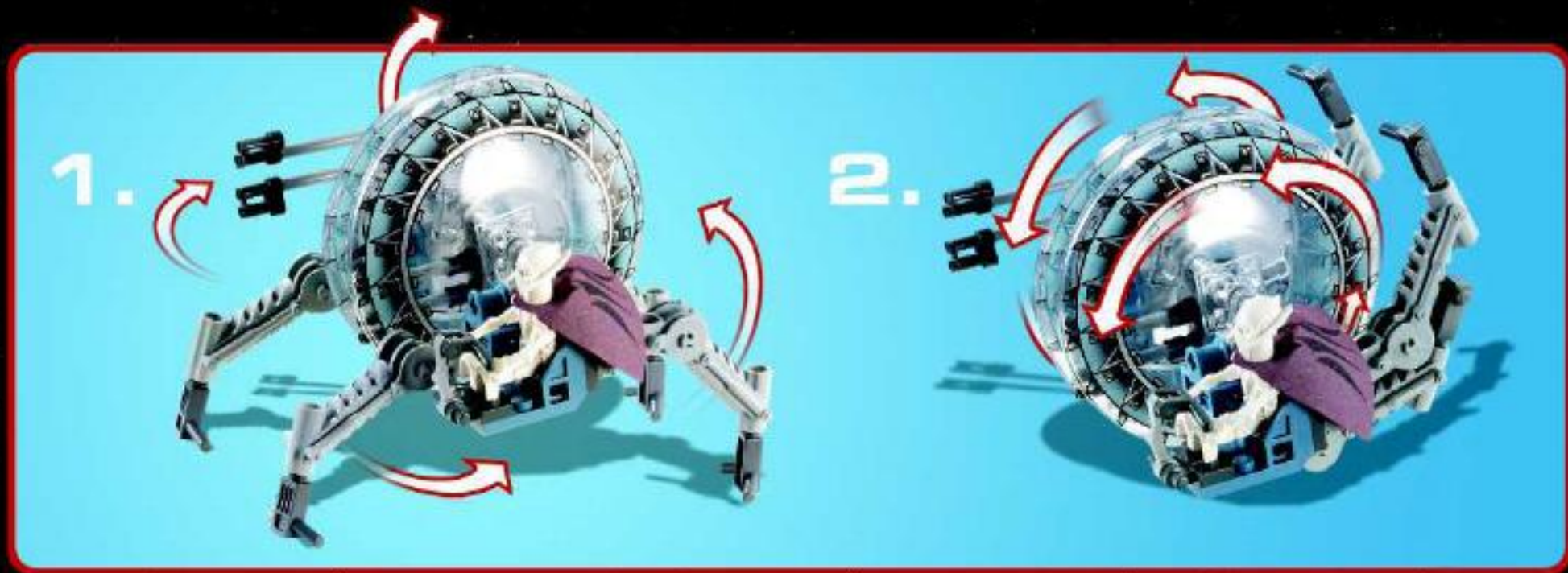





7251
Darth Vader™
Transformation



7256
Jedi Starfighter™
and Vulture Droid™

7259
Are-170 Starfighter™



7261 Clone Turbo Tank™



7250
Clone
Scout
Walker™



7257 Ultimate Lightsaber™ Duel



7252 Droid Tri-fighter™



7255 General Grievous™ Chase



7260 Wookiee Catamaran™



7258 Wookiee™ Attack





club



FREE!

Each LEGO Magazine Features...

- Awesome creations by Kids like you!
- Cool Comics & Stories
- Building Tips & Ideas
- Special Offers & Contest to WIN Prizes!

GRATUIT !

Chaque Magazine LEGO offre...

- Des créations épatantes par des jeunes comme toi !
- Des bandes dessinées et des récits super cool
- Des idées de construction
- Des offres spéciales et des concours pour gagner des prix !

Join Today! Abonne-toi dès aujourd'hui !

1-866-534-6258

www.LEGOclub.com



LEGO, the LEGO logo and trademarks are official trademarks of The LEGO Group. ©2006 The LEGO Group.

Win! Gagne !

WIN LEGO® PRODUCTS

Log on to www.acnielsen.alm.dk/LEGO for further instructions.

GAGNE DES PRODUITS LEGO®

Visite www.acnielsen.alm.dk/LEGO pour plus d'informations.

ESTIMADO USARIO LEGO®

Al contestar algunas preguntas en ingles, frances, aleman o japonés en el sitio www.acnielsen.alm.dk/LEGO, podras participar en el sorteo de algunas valiosos premios LEGO®.

www.acnielsen.alm.dk/LEGO





SHOP at HOME

The World's Biggest LEGO® Shop!

For a Free Catalog in the U.S.
and Canada, call toll-free:

1-800-446-8107

Or go online:

www.LEGOshop.com/catalog

Pour obtenir un Catalogue GRATUIT
aux États-Unis et au Canada,
téléphonez sans frais au :

1-800-267-5346

Ou venez en ligne sur :

www.LEGOshop.com/catalog

LEGO STAR WARS™

THE VIDEO GAME



4276597

©2005 The LEGO Group.



LEGO, the LEGO logo and the Minifigure are trademarks of The LEGO Group. © 2004 The LEGO Group. © 2004 Lucasfilm Entertainment Company Ltd. or Lucasfilm Ltd. & © or TM as Indicated. All rights reserved. Microsoft, Xbox and the Xbox logos are either registered trademarks or trademarks of Microsoft Corporation in the U.S. and/or in other countries and are used under license from Microsoft. All rights reserved. "PS" and "PlayStation" are registered trademarks of Sony Computer Entertainment Inc. All rights reserved. GAME BOY ADVANCE IS A TRADEMARK OF NINTENDO. The NVIDIA logo and "The way it's meant to be played" logo are registered trademarks or trademarks of NVIDIA Corporation.

