

The LEGO logo is displayed in its characteristic white font with a black outline, set against a red square background.

**⚠ WARNING: CHOKING HAZARD.**

Toy contains small parts and a small ball.  
Not for children under 3 years.

**⚠ AVERTISSEMENT : RISQUE D'ÉTOUFFEMENT.**

Le jouet contient des petites pièces ainsi qu'une petite balle.  
Il ne convient pas aux enfants de moins de 3 ans.

**⚠ ADVERTENCIA: PELIGRO DE ASFIXIA.**

Juguete que contiene partes pequeñas y una pelota  
pequeña. No recomendado para niños menores de 3 años.

4726

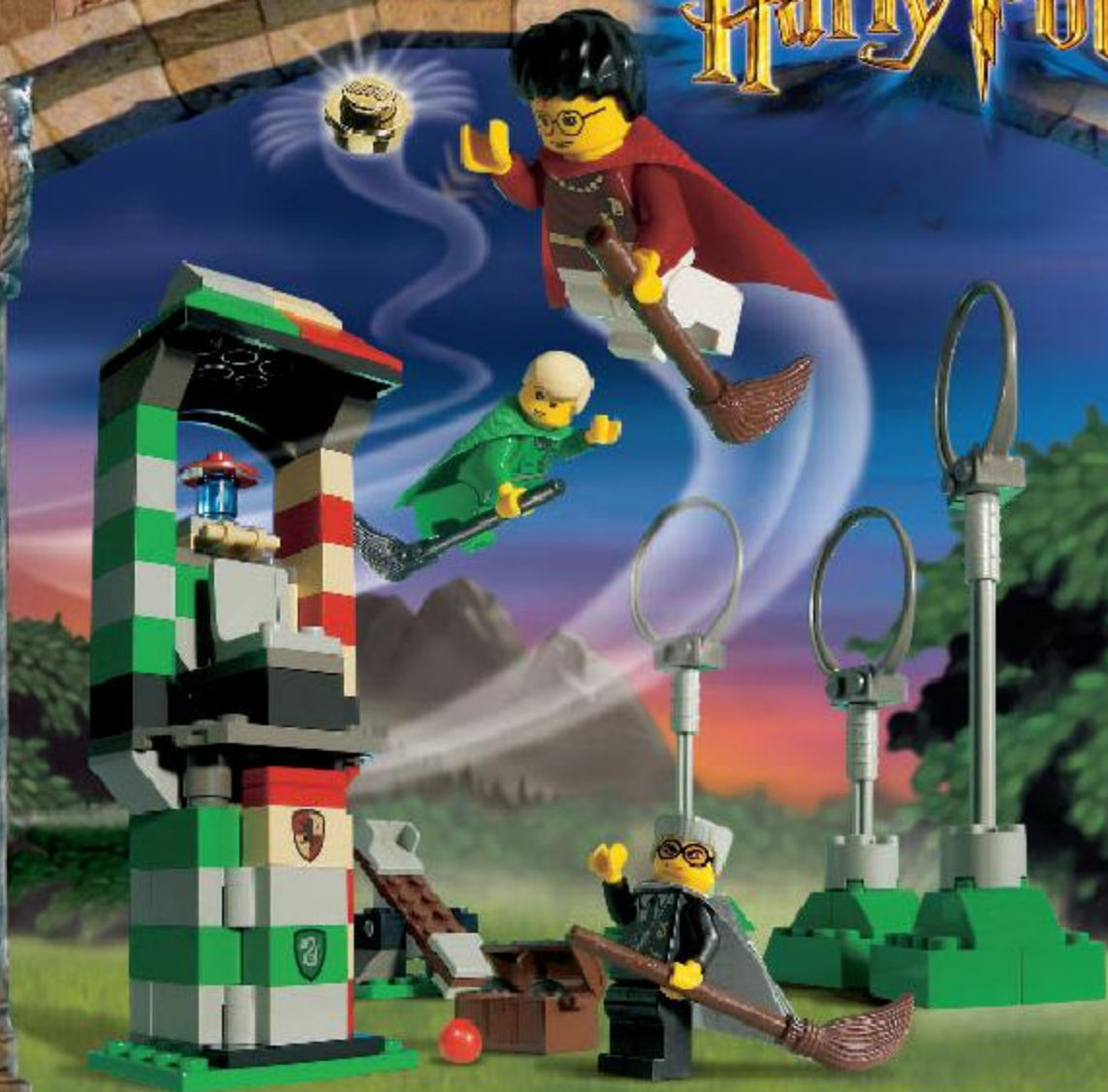
The Harry Potter logo is written in a stylized, golden, gothic font with a lightning bolt through the letter 'P'. It is set against a blue, glowing, circular background that resembles a magical portal or a moon.

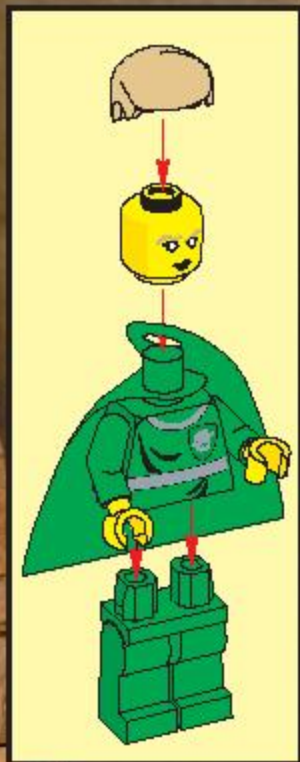

1

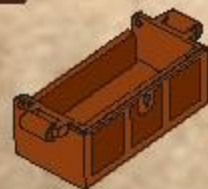

2

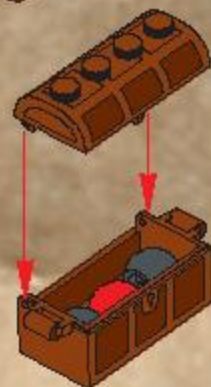

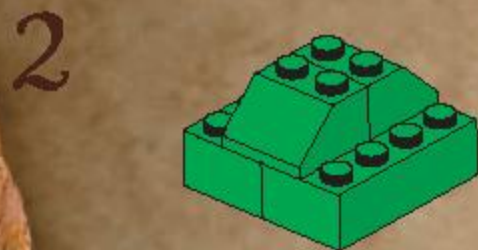
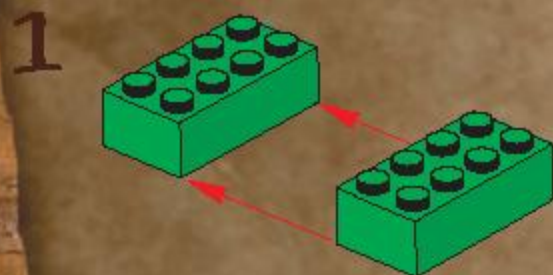
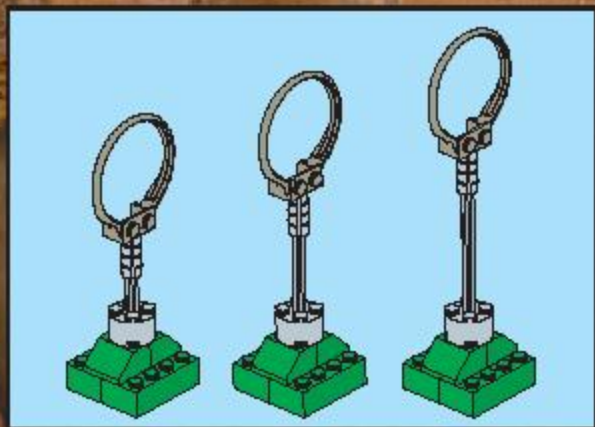

3

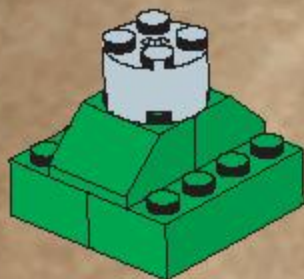

4

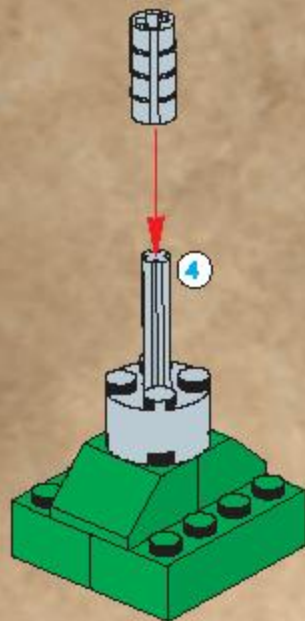

5

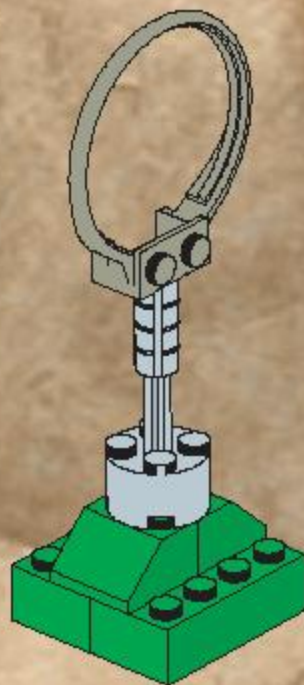

1

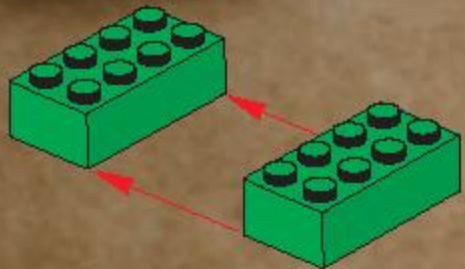

2

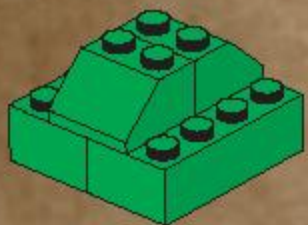

3

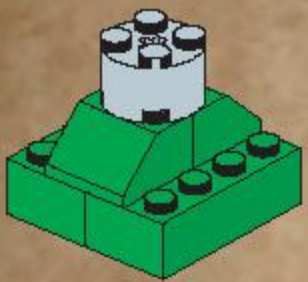

4

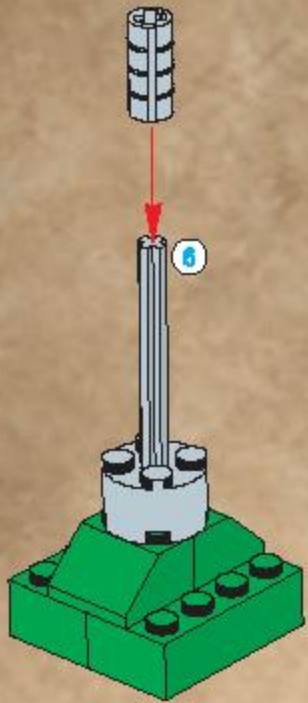

5

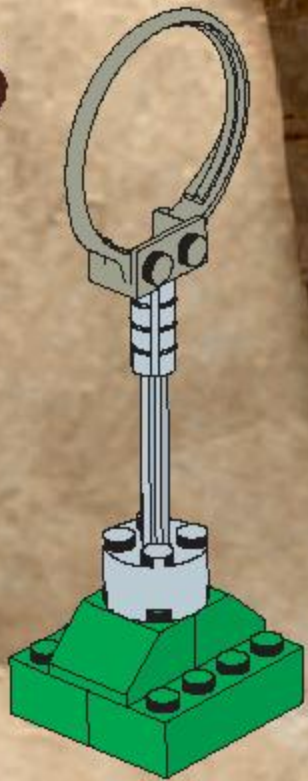

1

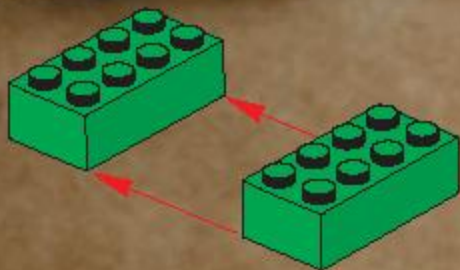

2

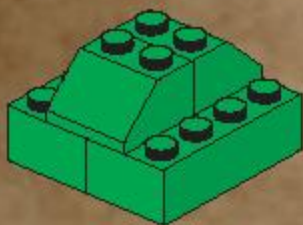

3

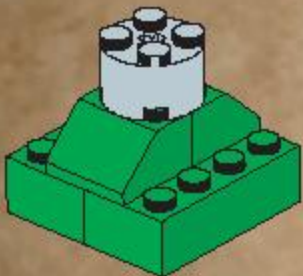

4

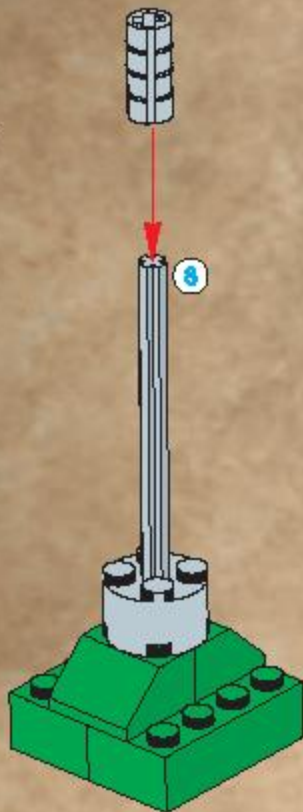

5

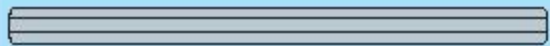
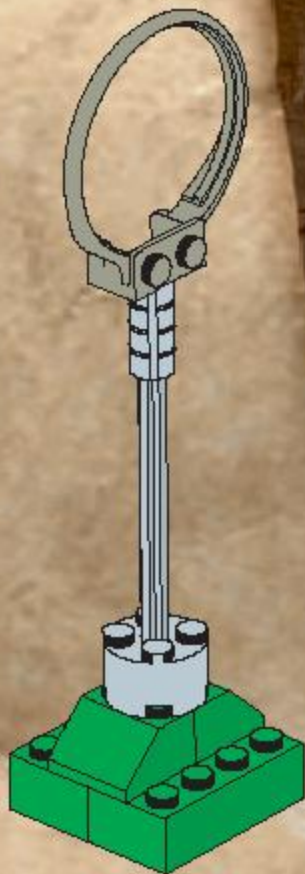

1:1

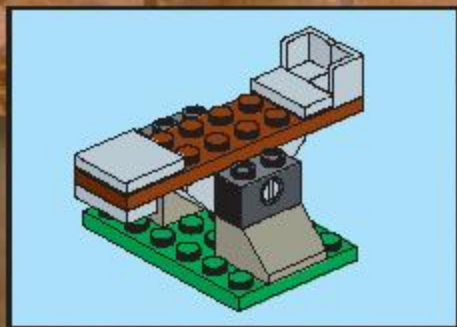

1



2

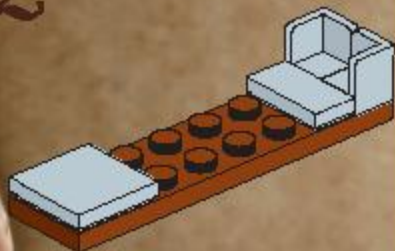

3

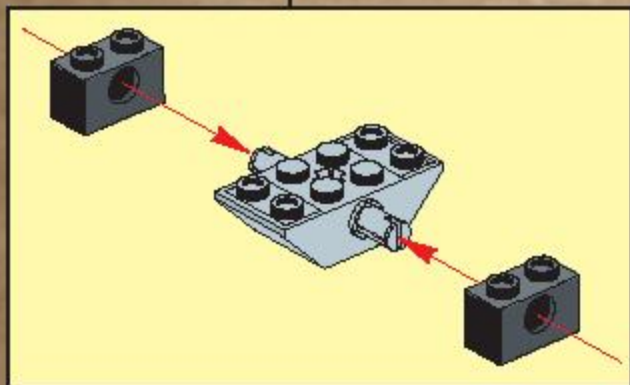
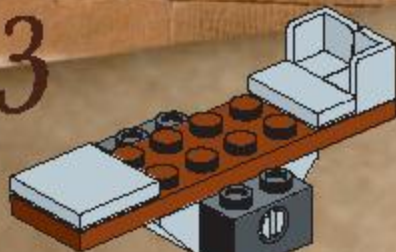

4

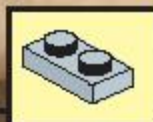
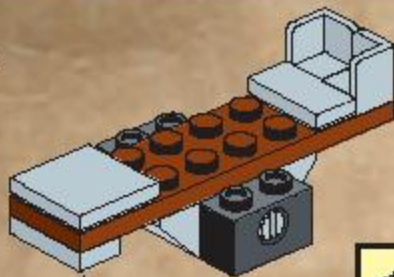

5

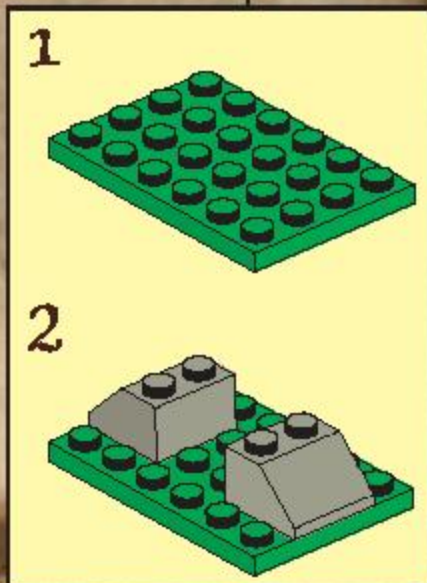
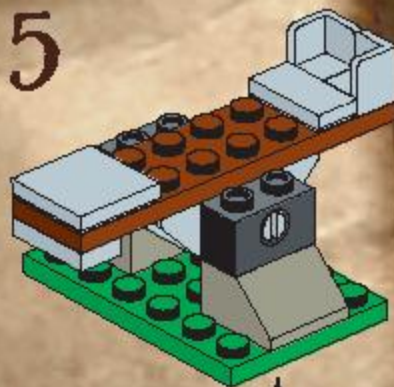

1

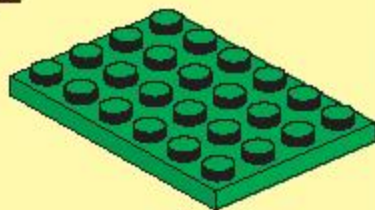

2

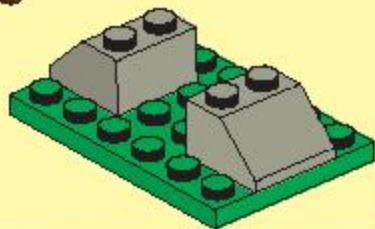

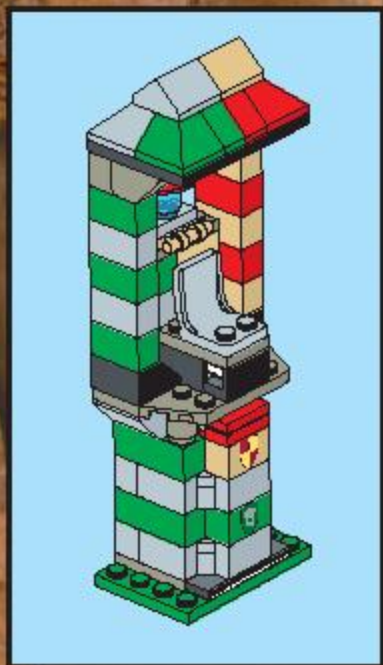

1

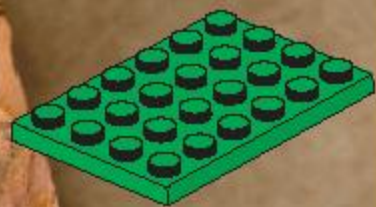

2

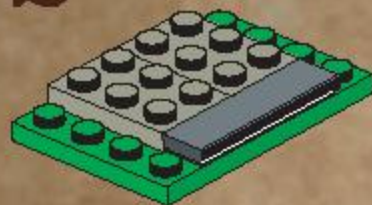

3

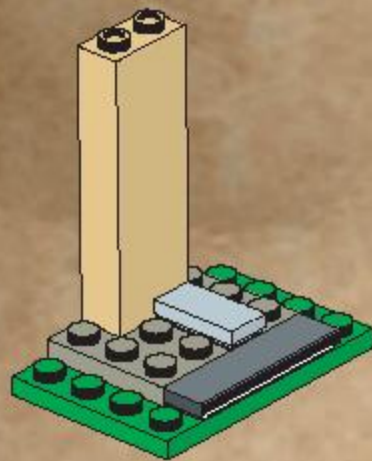

4

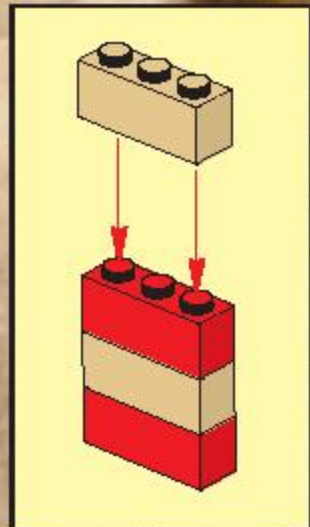
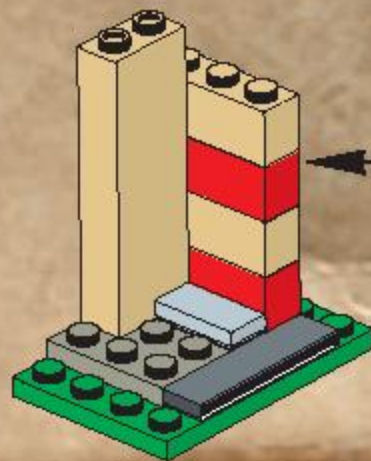

5

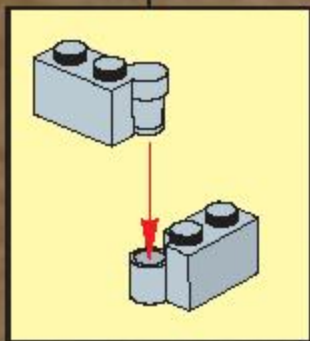
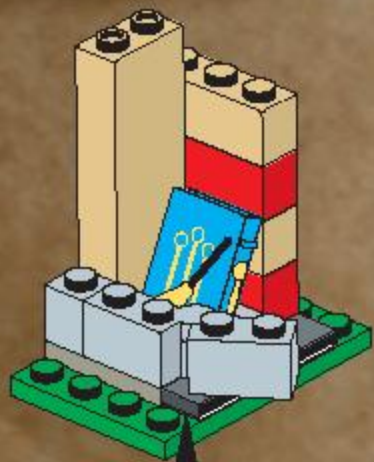

6

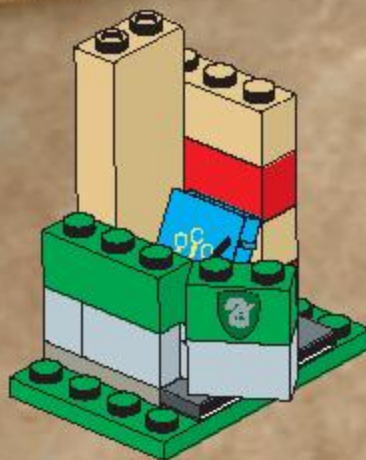

7

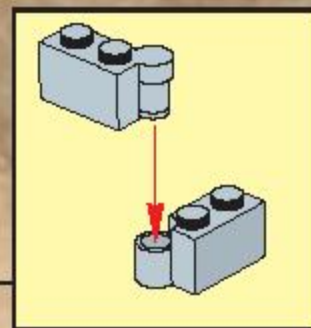
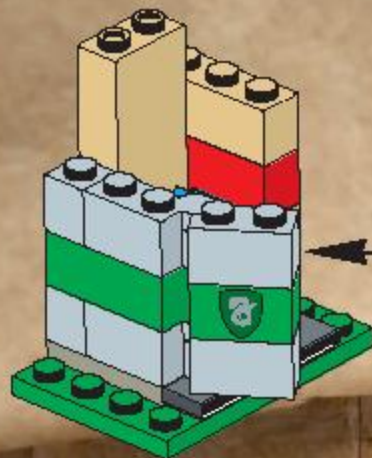



8

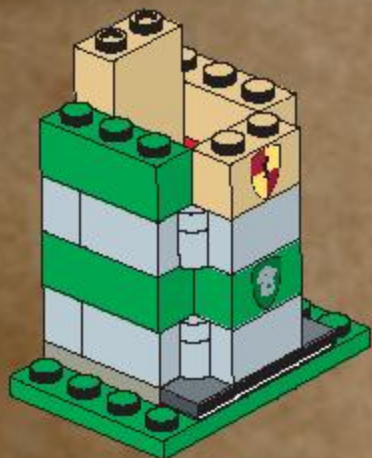

9

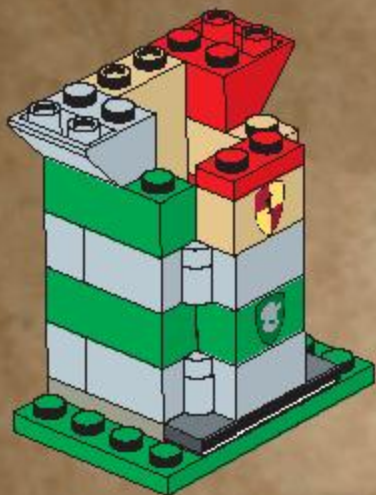

10

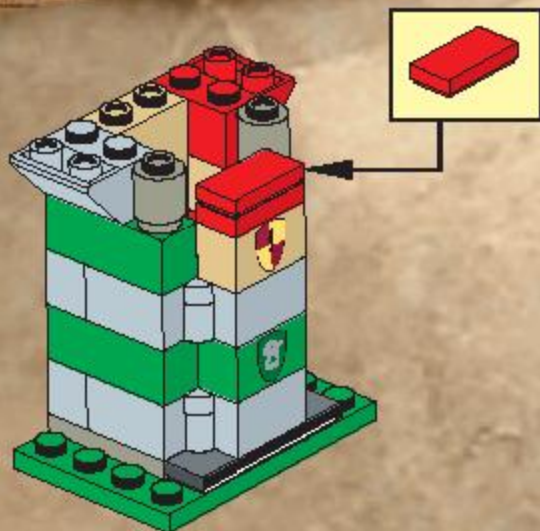

11

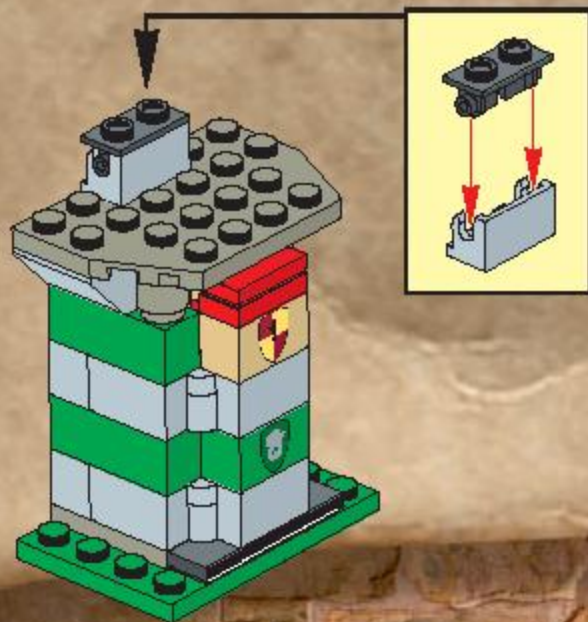

12

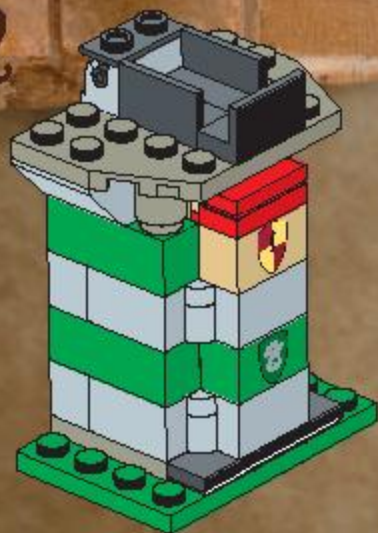

13

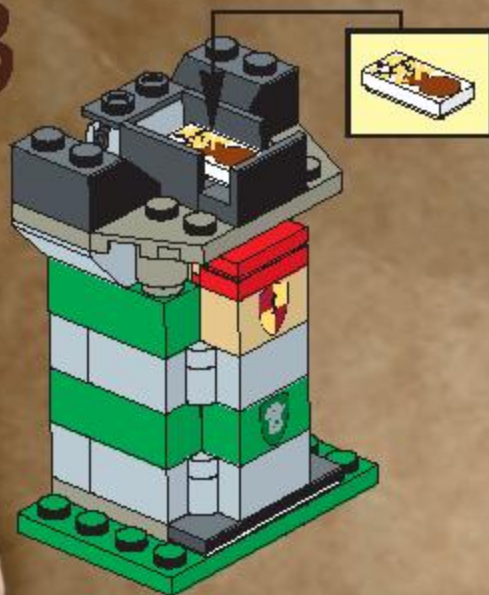

14

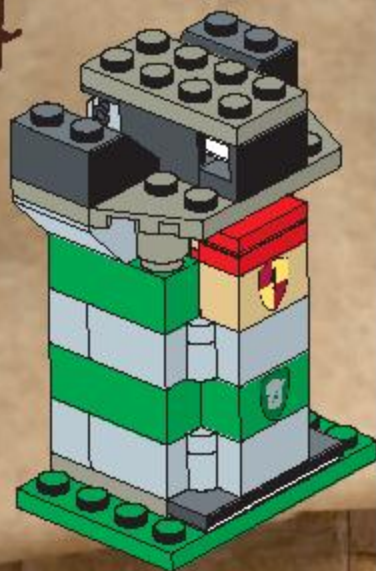

15

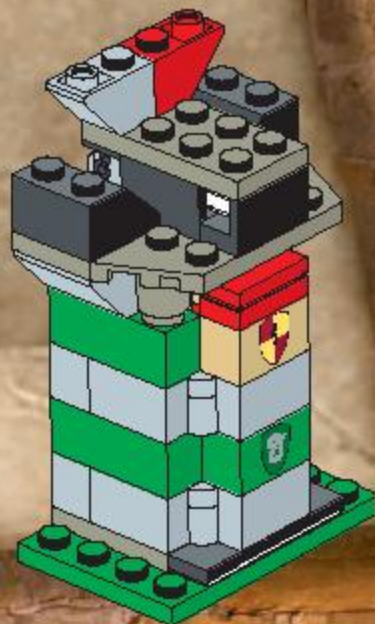

16

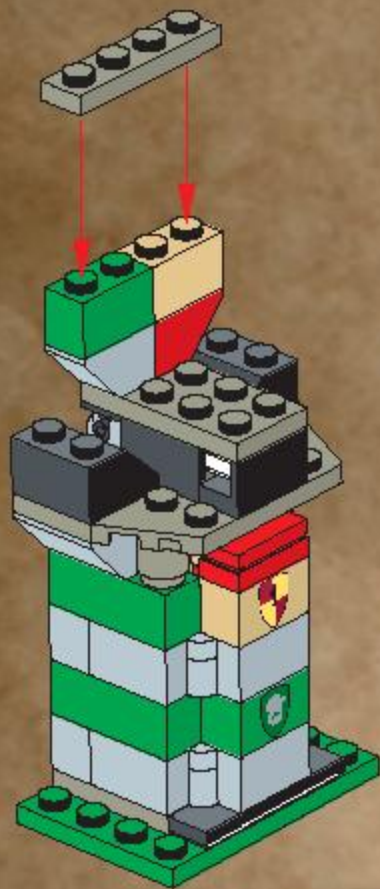

1



2



3



4



17

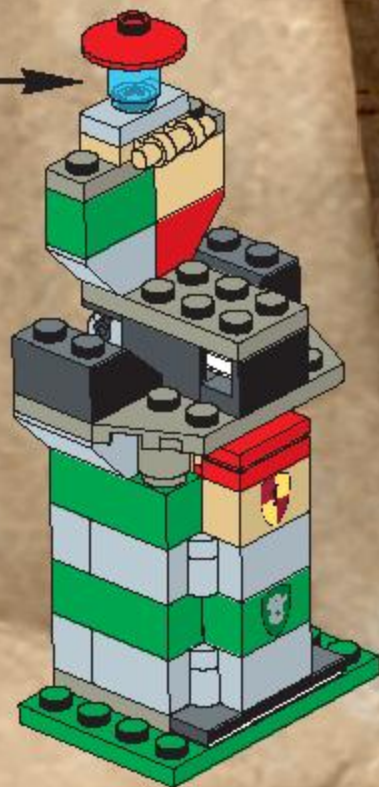

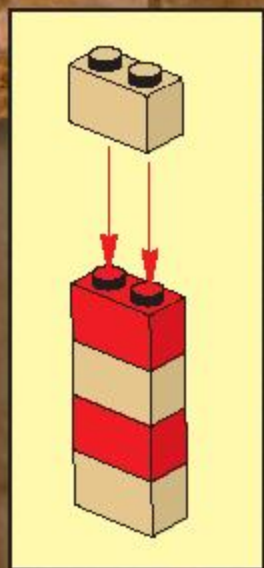

18

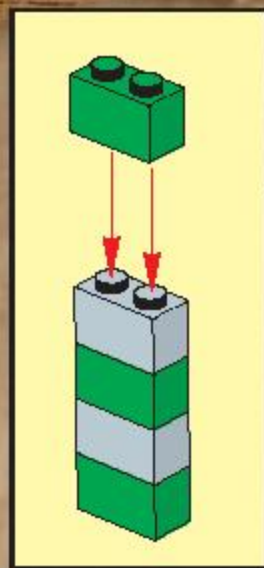
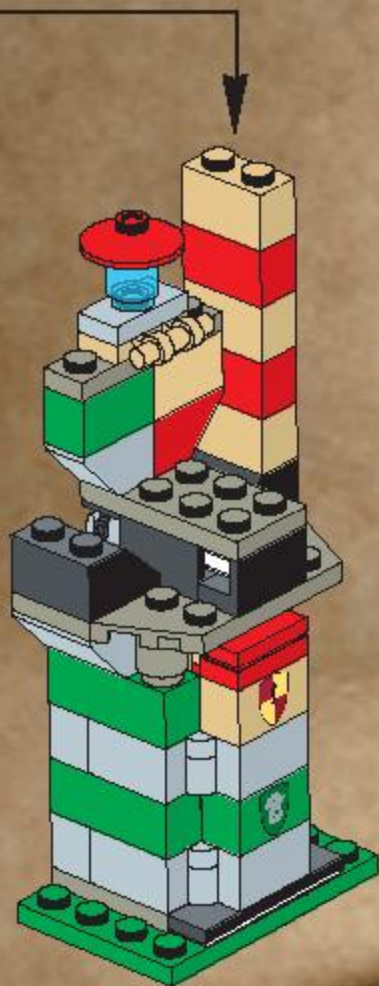

19

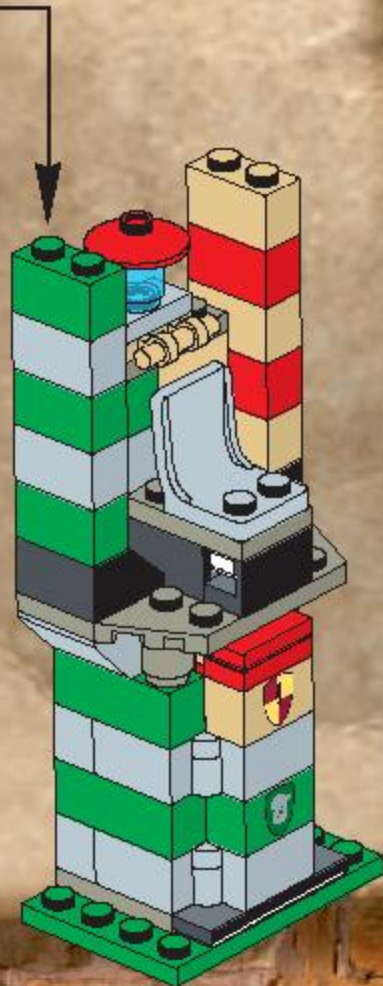

20

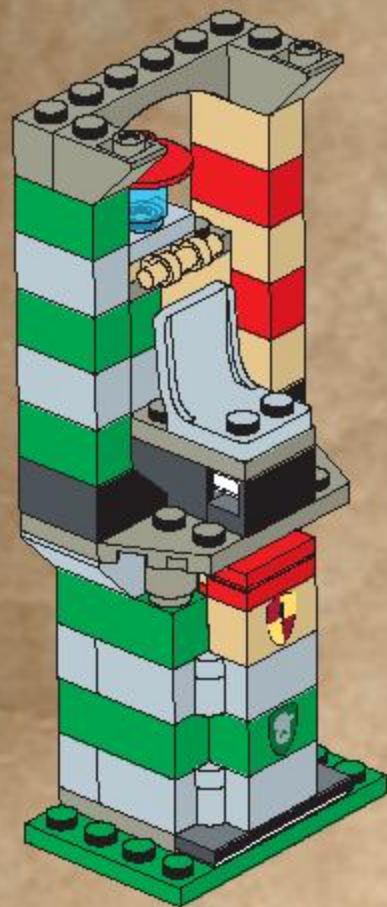

1

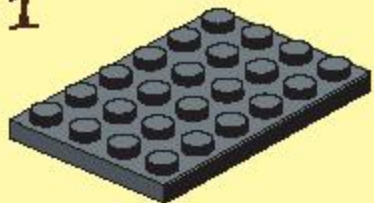

2

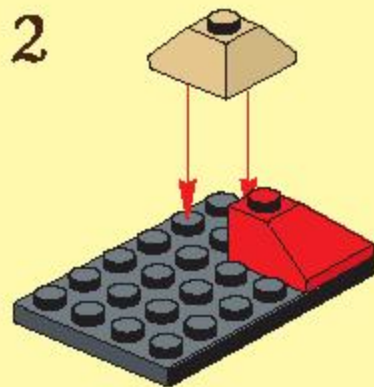

3

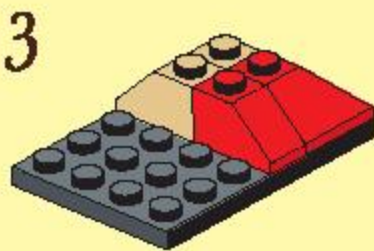

4

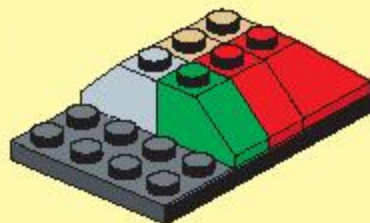

5

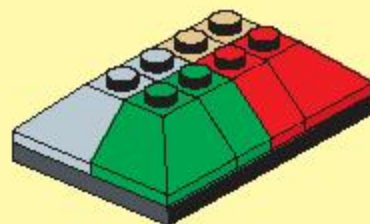

6

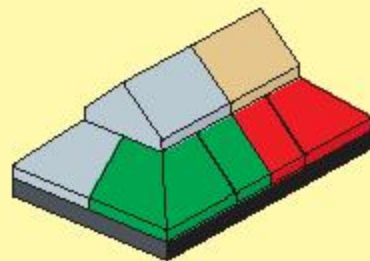

21

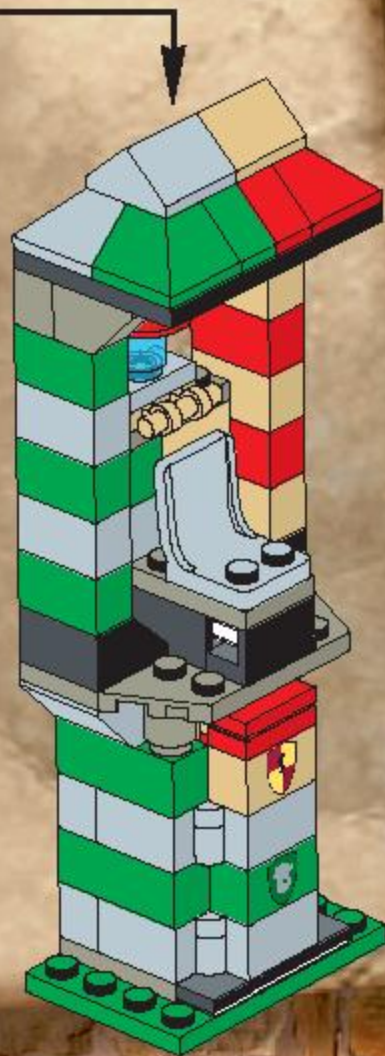



LEGO and the LEGO logo are trademarks of the LEGO Group.  
©2002 The LEGO Group.

HARRY POTTER, characters, names and related indicia are trademarks of  
and © Warner Bros.  
Harry Potter Publishing Rights © J.K. Rowling.  
[182]



LEGO and the LEGO logo are trademarks of the LEGO Group.  
©2002 The LEGO Group.

HARRY POTTER, characters, names and related indicia are trademarks of and © Warner Bros.

WB SHIELD: TM & © Warner Bros.

Harry Potter Publishing Rights © J.K. Rowling

(02)

[www.harrypotter.com](http://www.harrypotter.com)

[www.LEGO.com](http://www.LEGO.com)

JOIN THE FUN!