

LEGO

Harry Potter

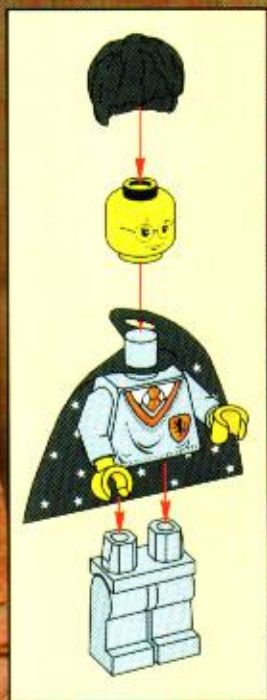

4733



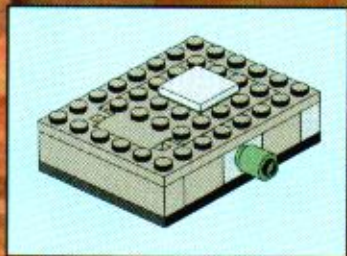
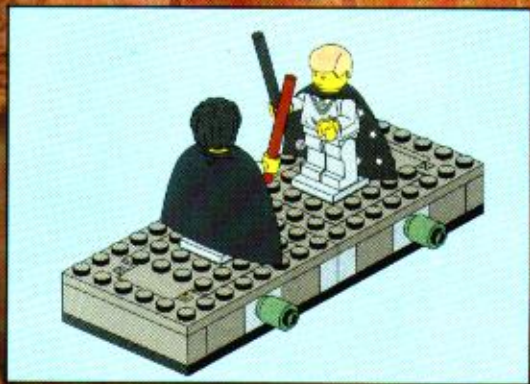

1



2

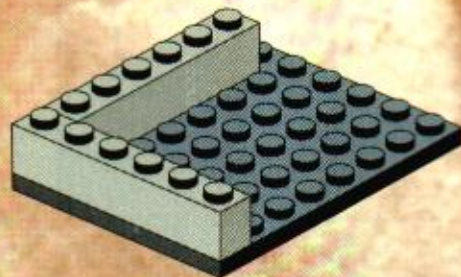

3

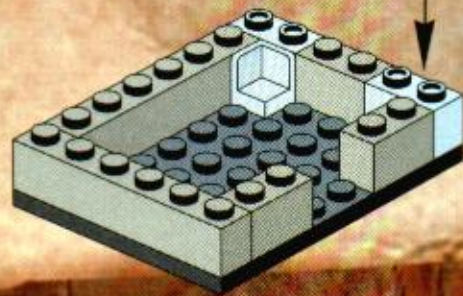
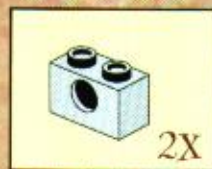

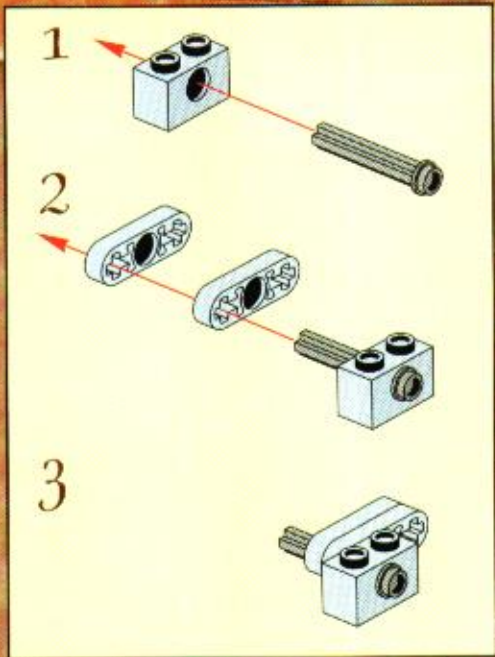

4

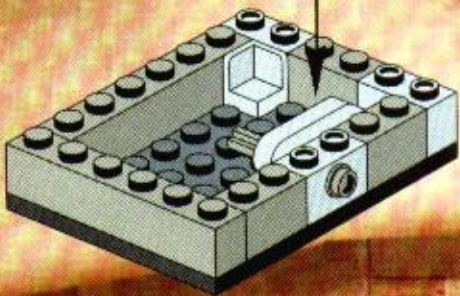

1

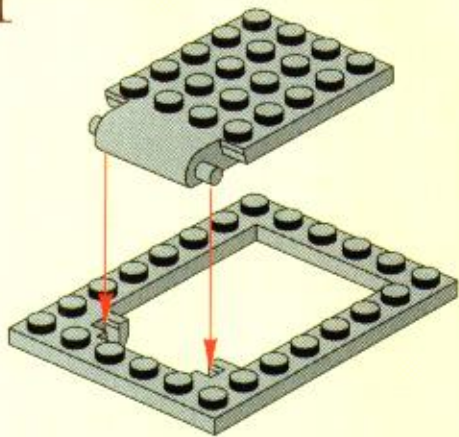

2

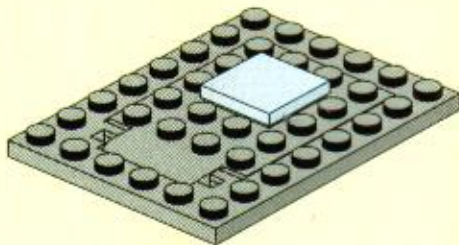

5

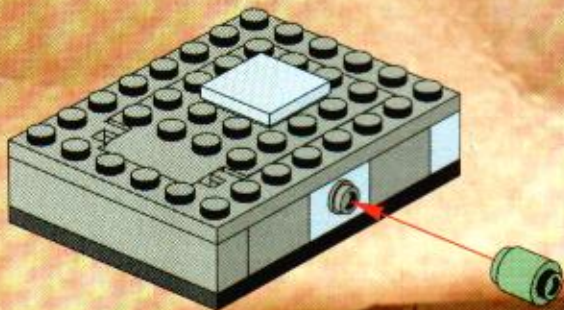

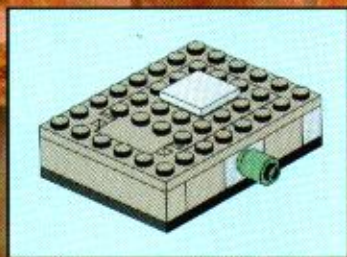

1



2

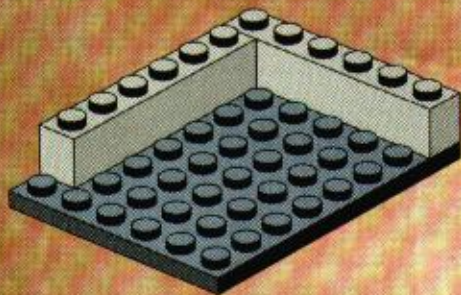

3

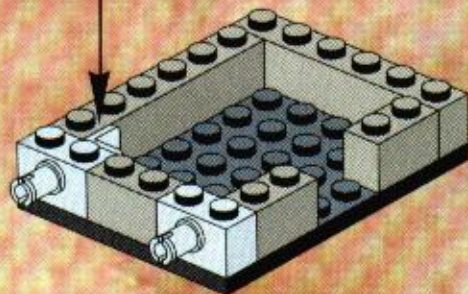
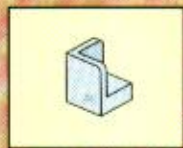

1

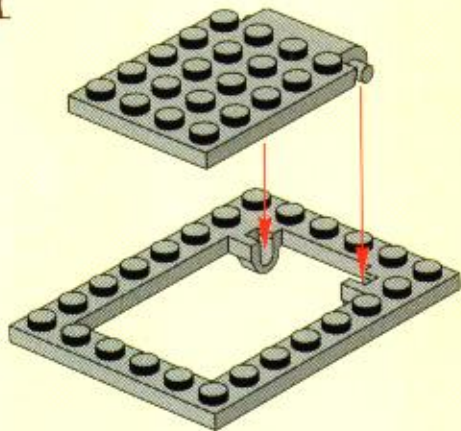

2

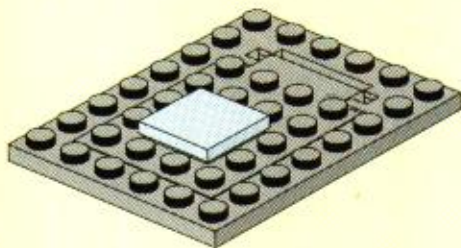

5

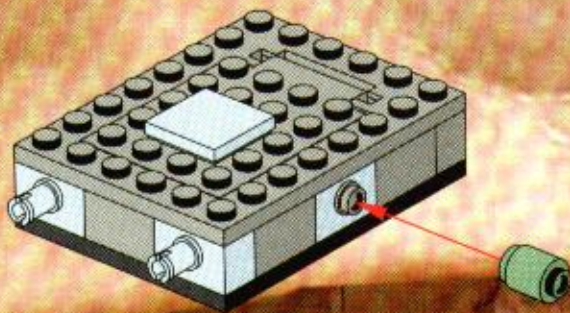

6

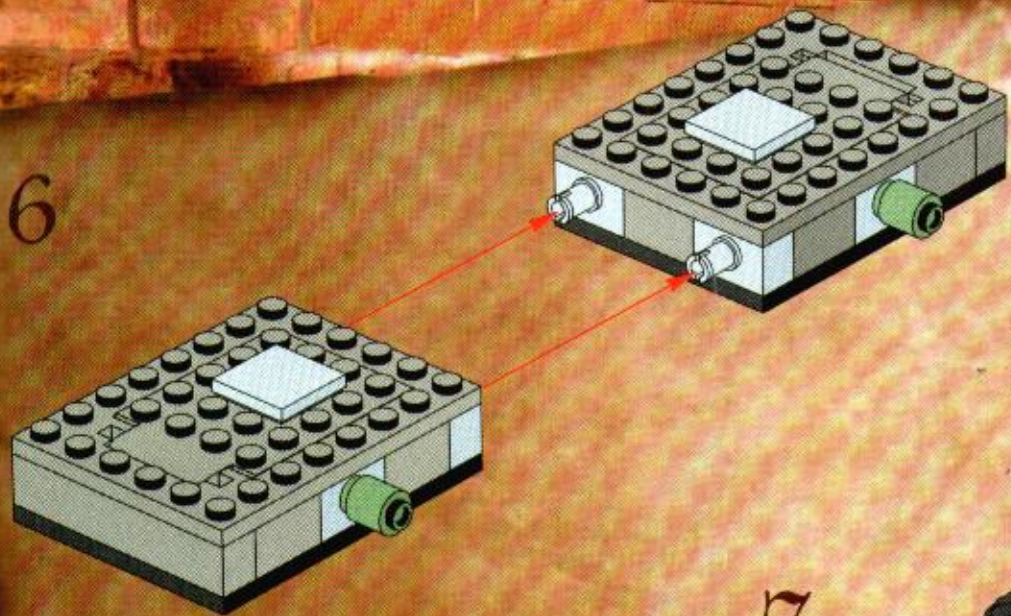

7



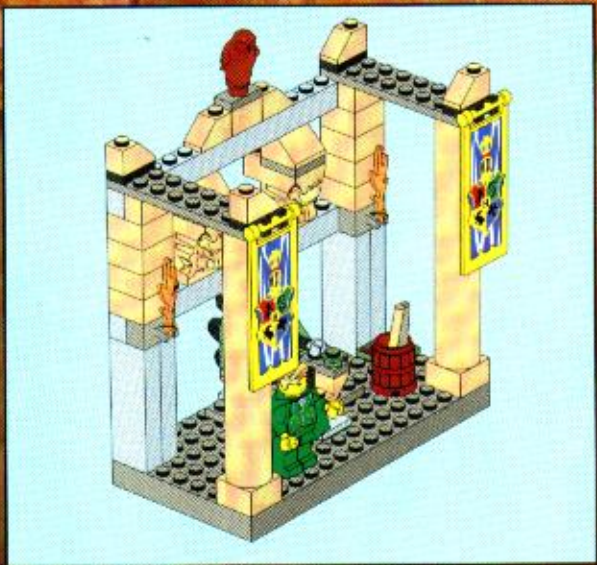

1

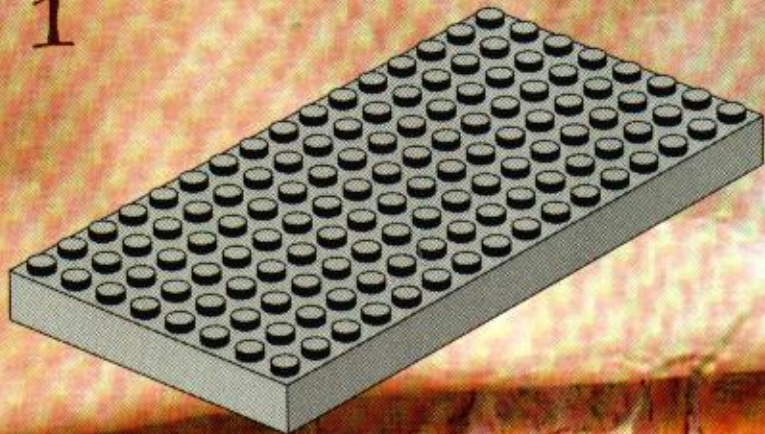

2

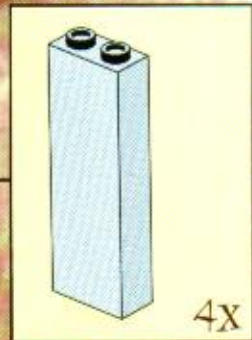
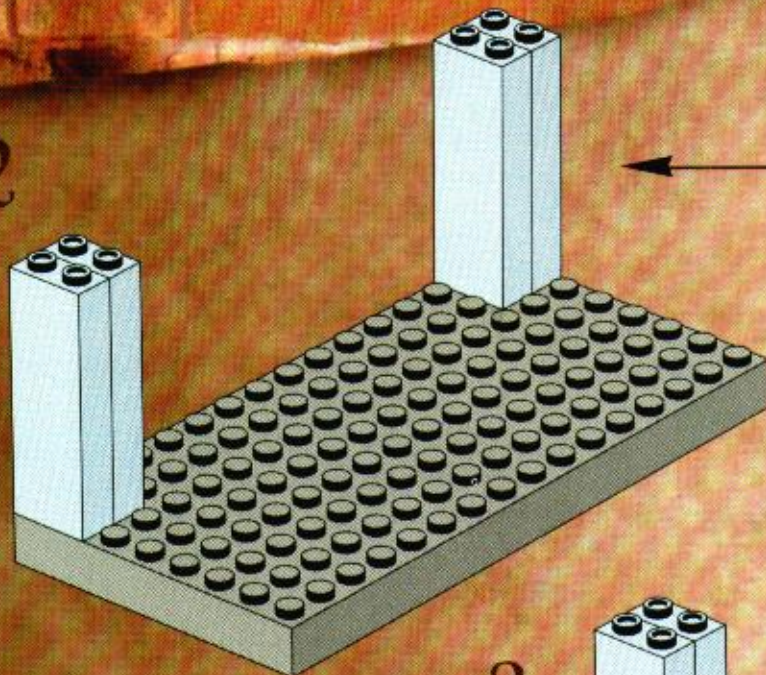

3

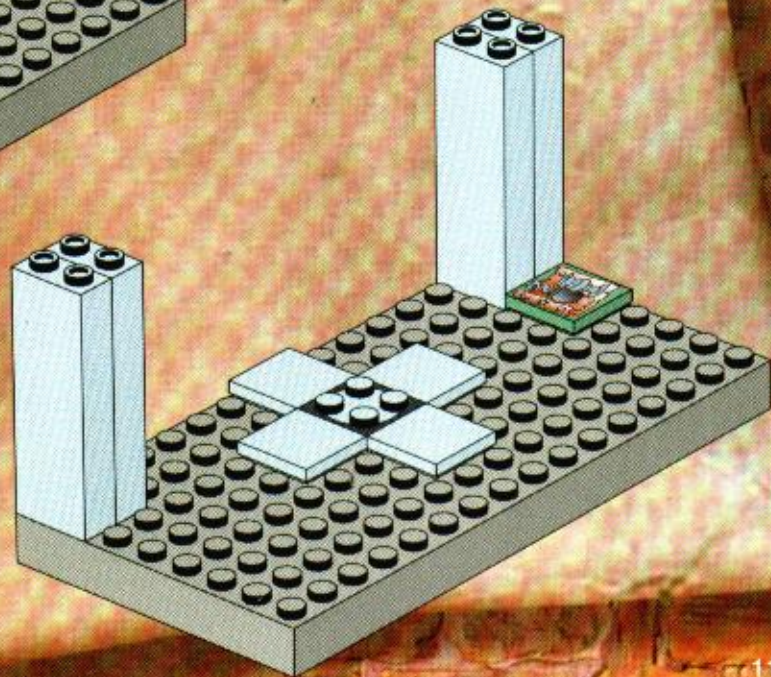

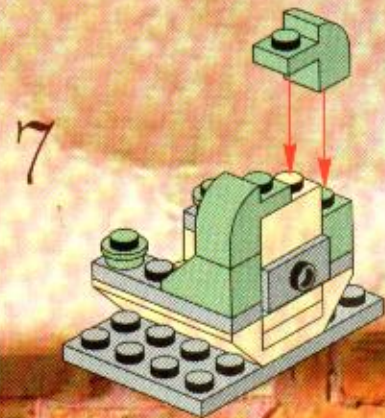
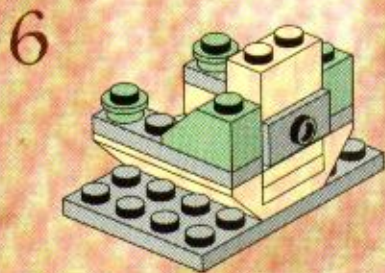
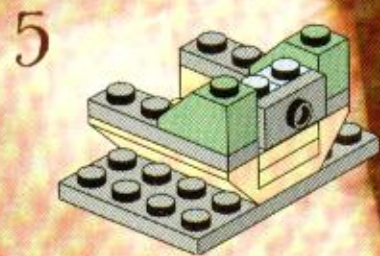
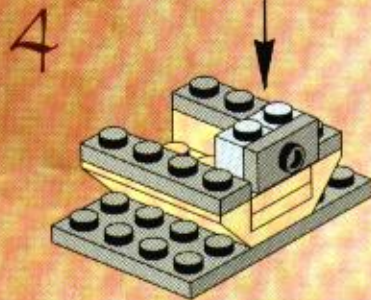
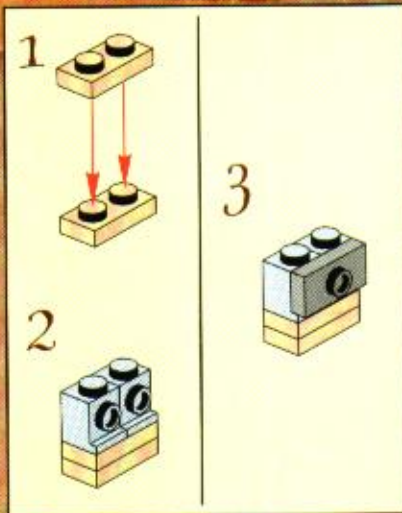
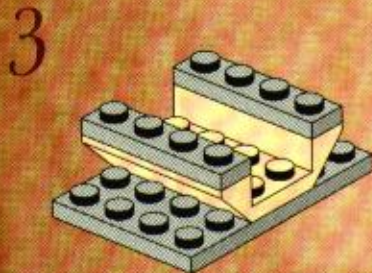
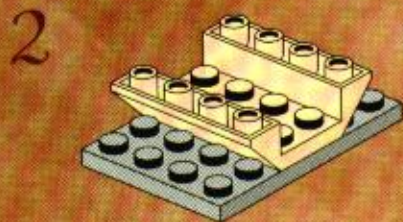

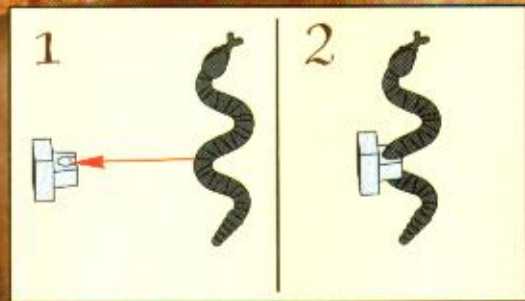

8

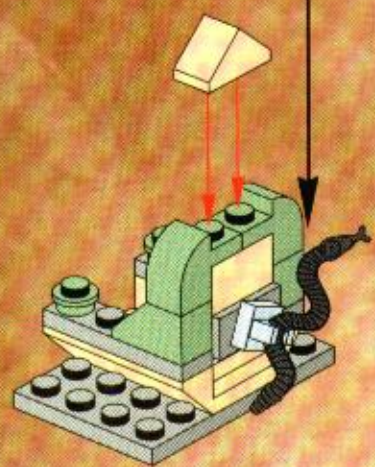

4

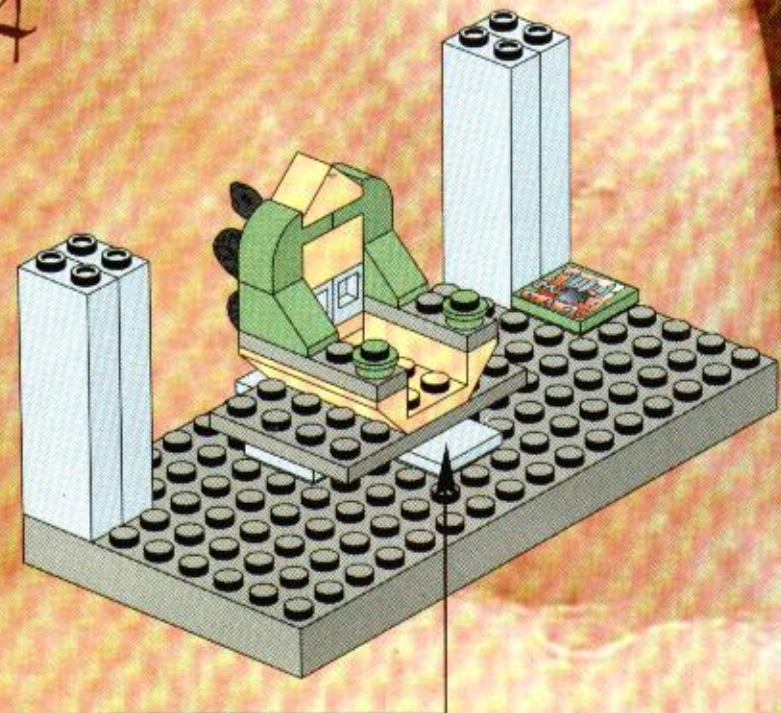

5

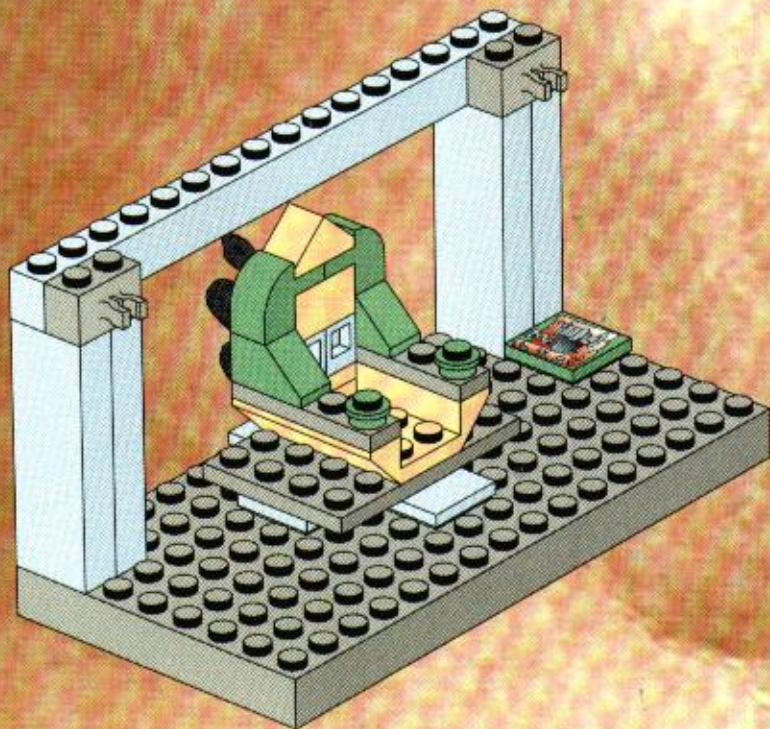

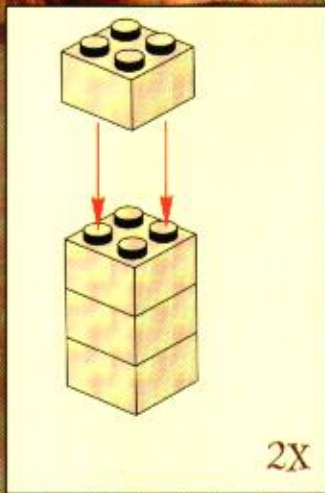

6

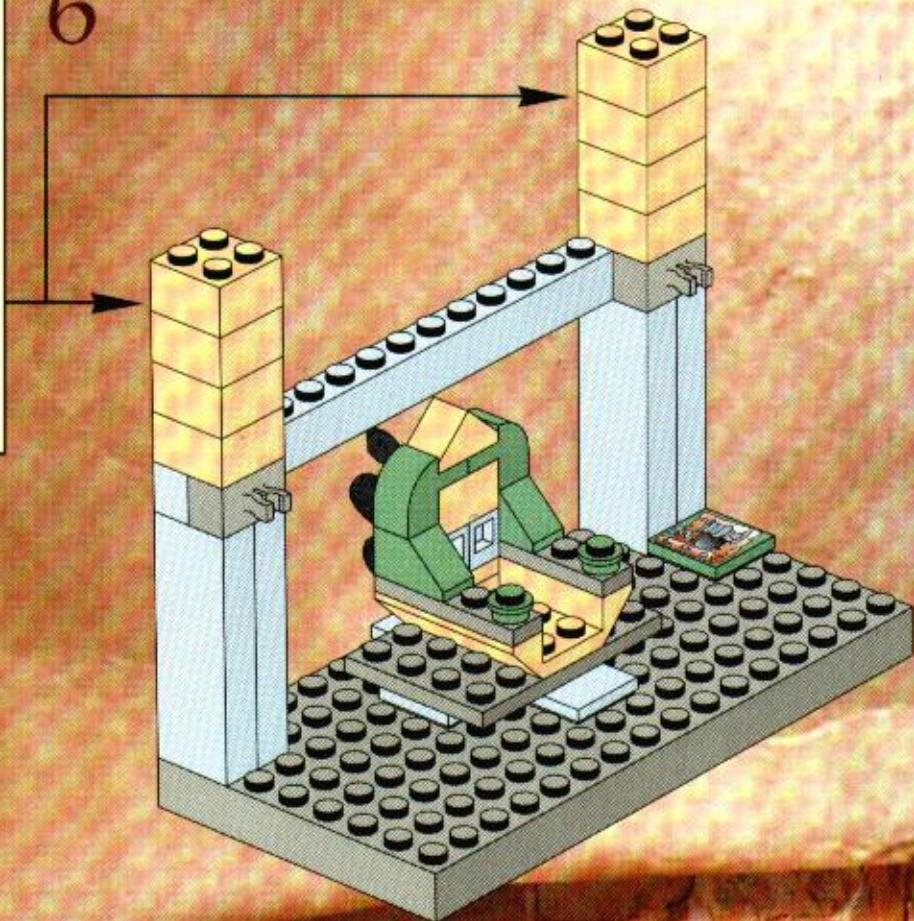

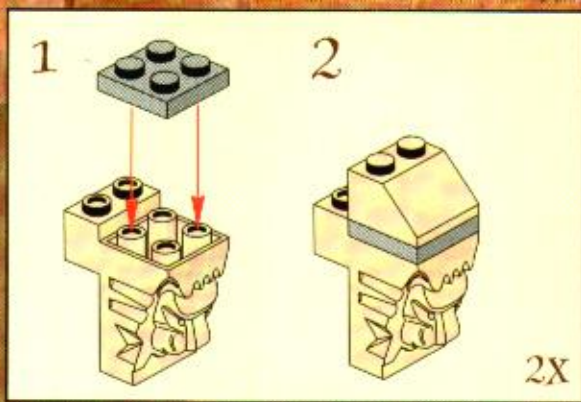

7

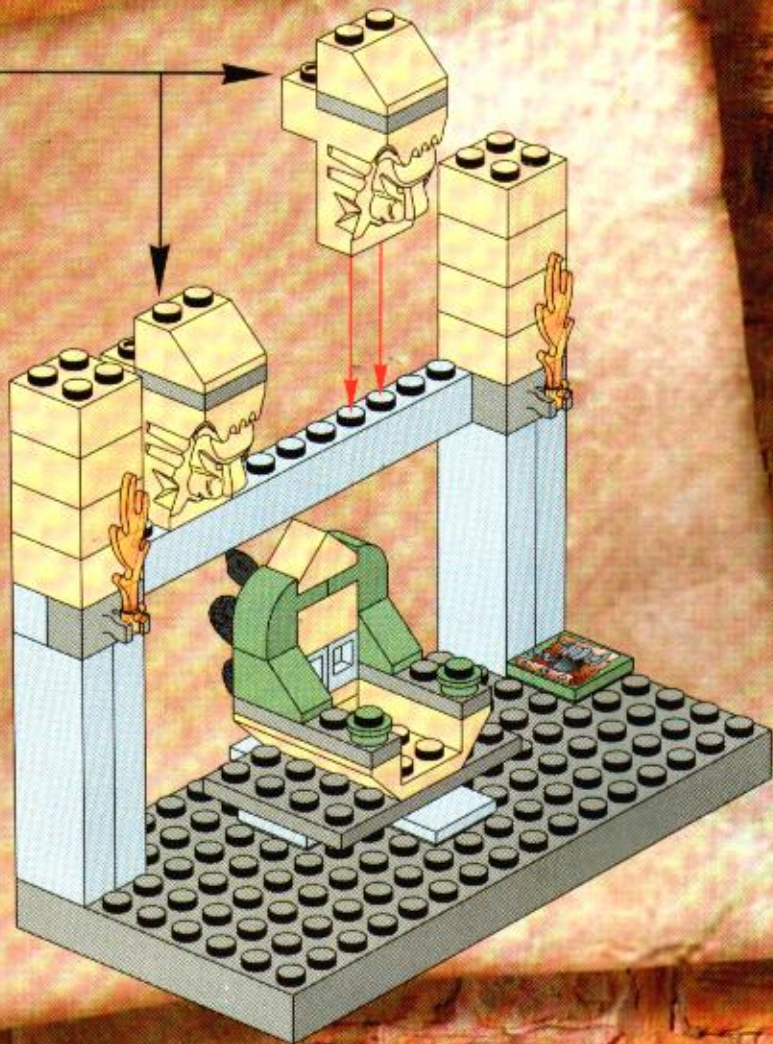

8

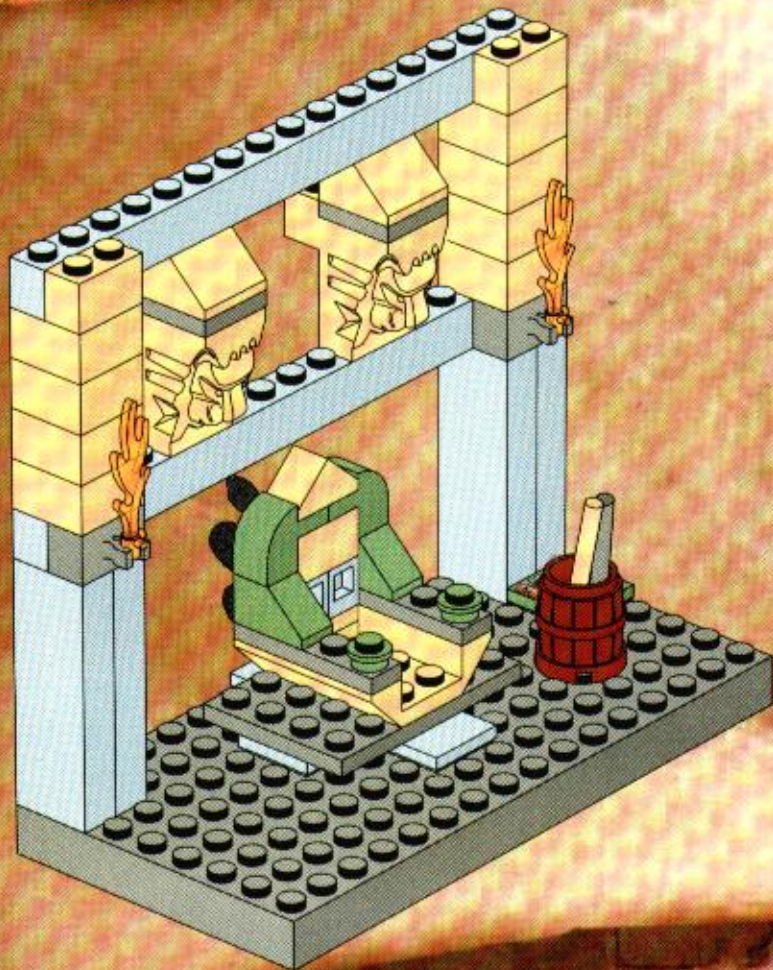

9

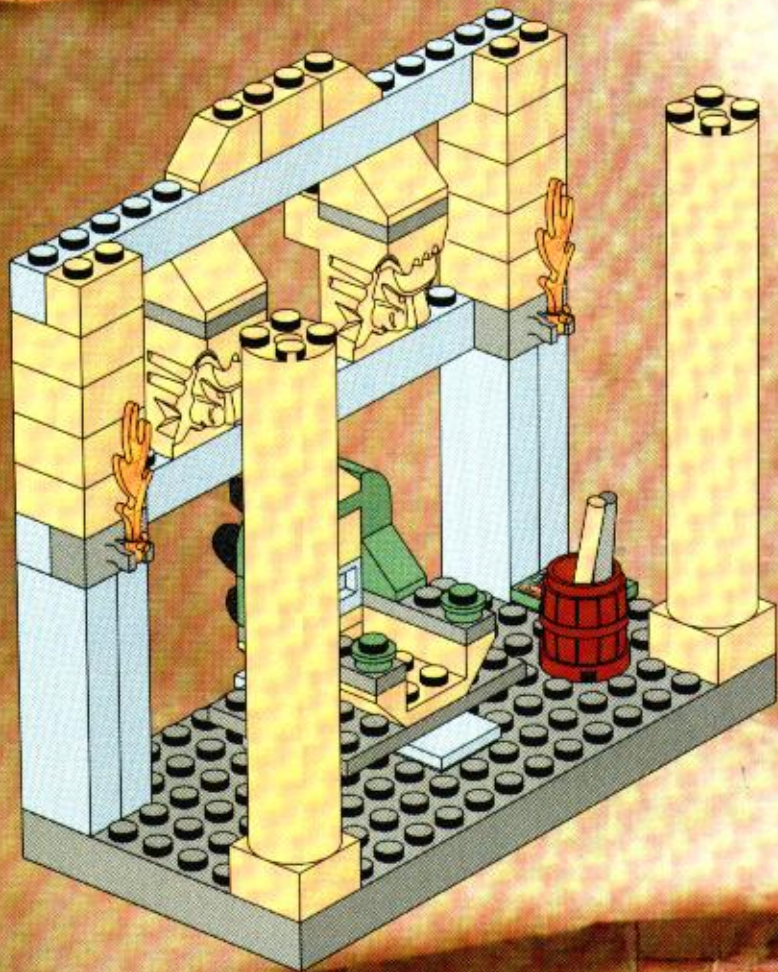

10

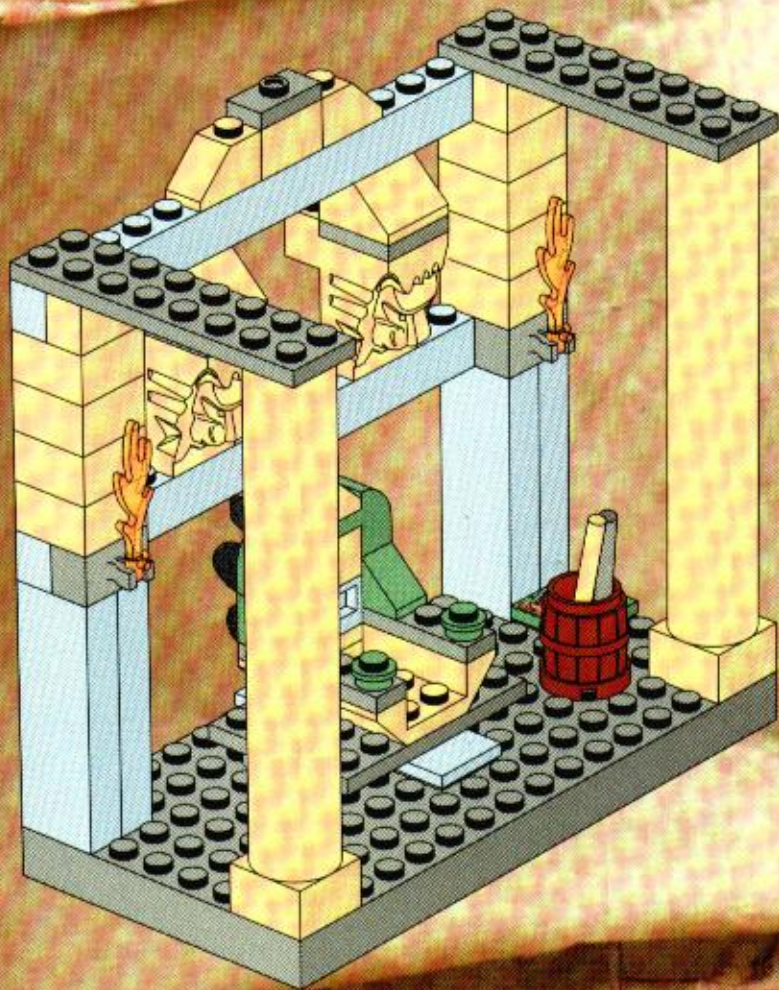

11

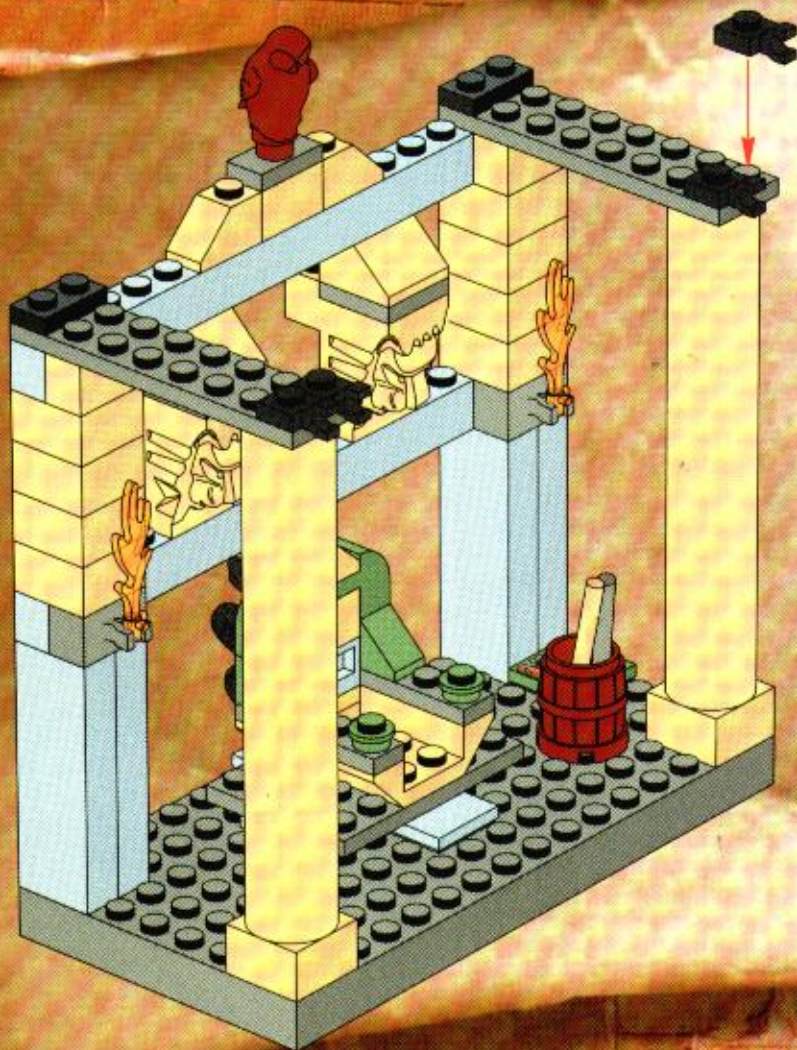

12

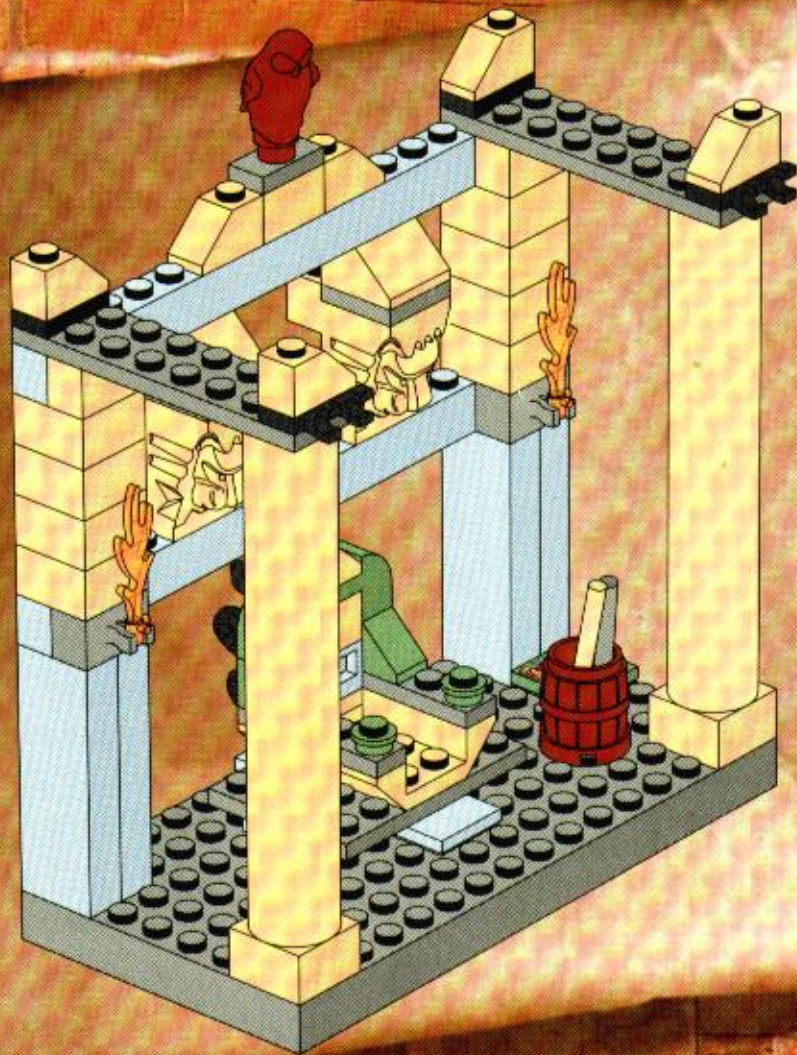

13

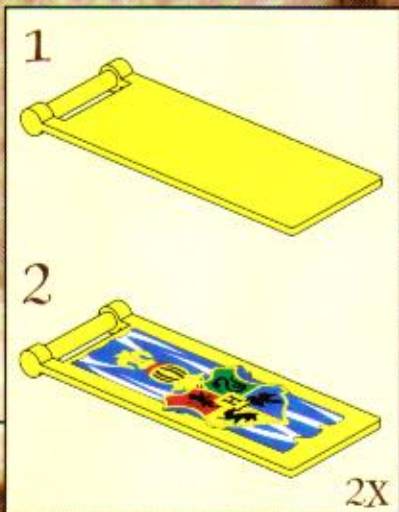
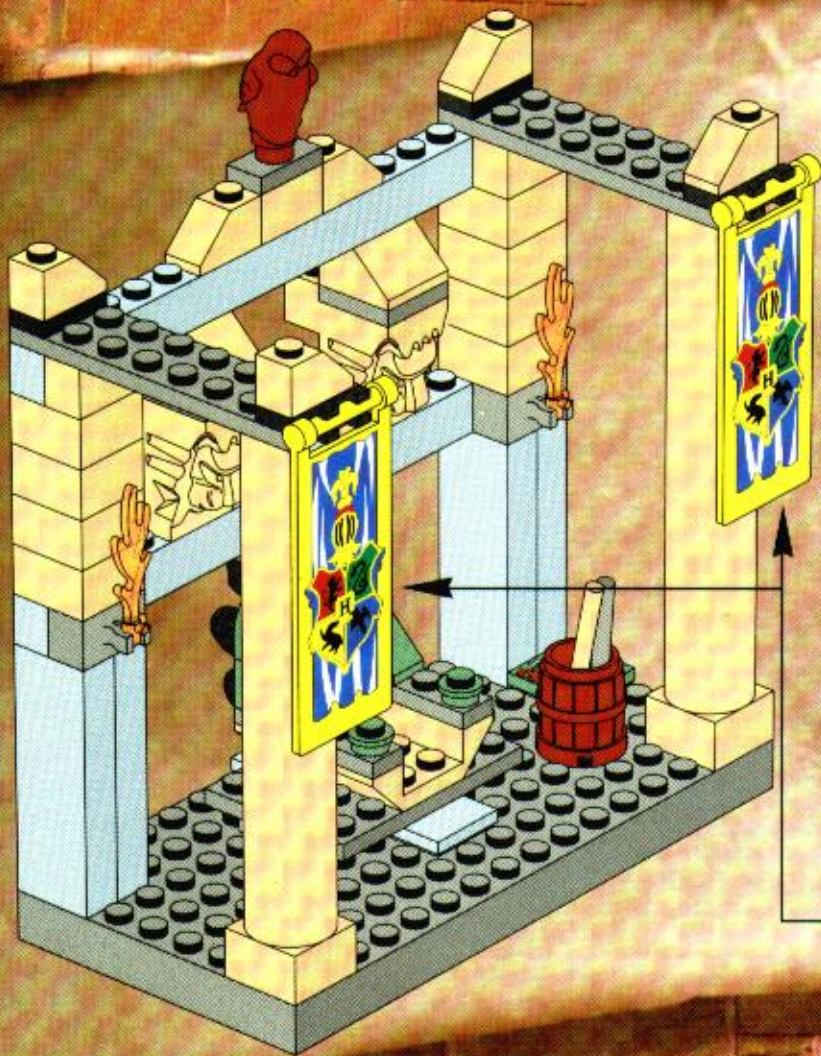

14





LEGO and the LEGO logo are trademarks of the LEGO Group.
©2002 The LEGO Group.

HARRY POTTER, characters, names and related indicia are trademarks of and © Warner Bros.

WB SHIELD: TM & © Warner Bros.

Harry Potter Publishing Rights © J.K. Rowling.

(s02)



www.harrypotter.com

www.LEGO.com

JOIN THE FUN!



44364/4180081 © 2002 LEGO GROUP

