

**LEGO** **SYSTEM**

6837

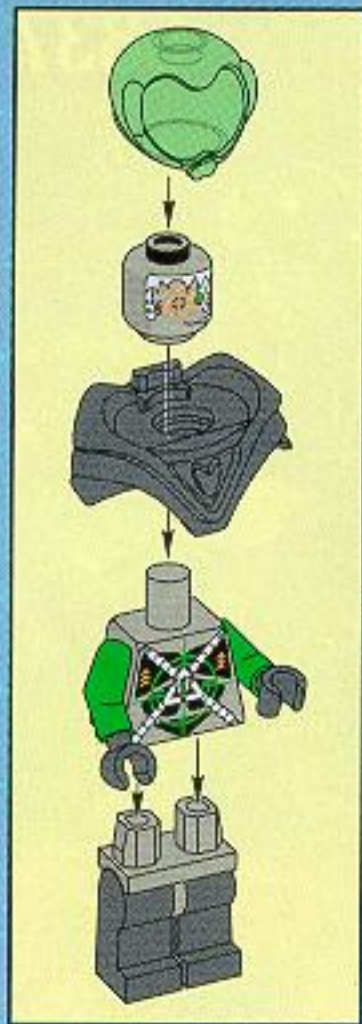





1

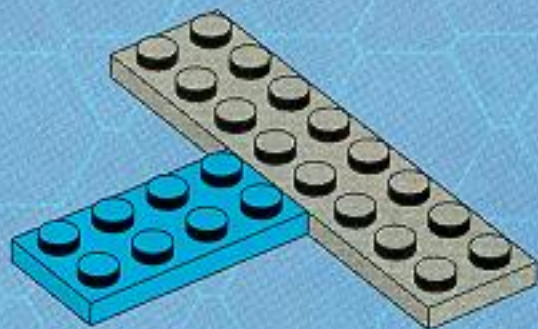

2

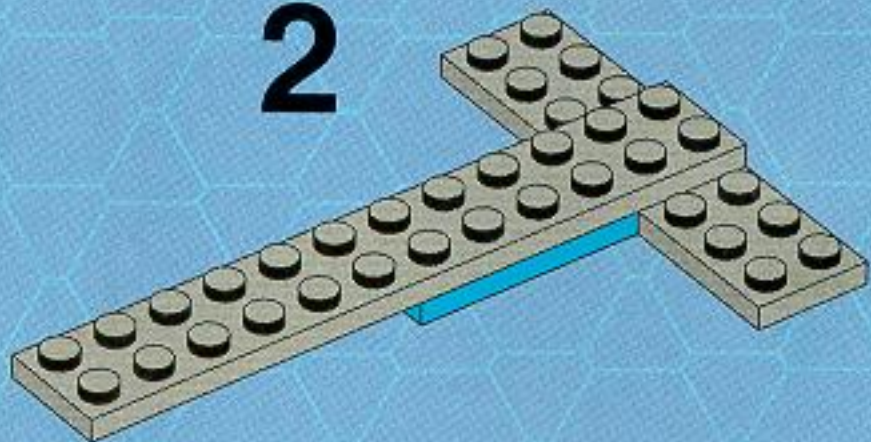

# 3

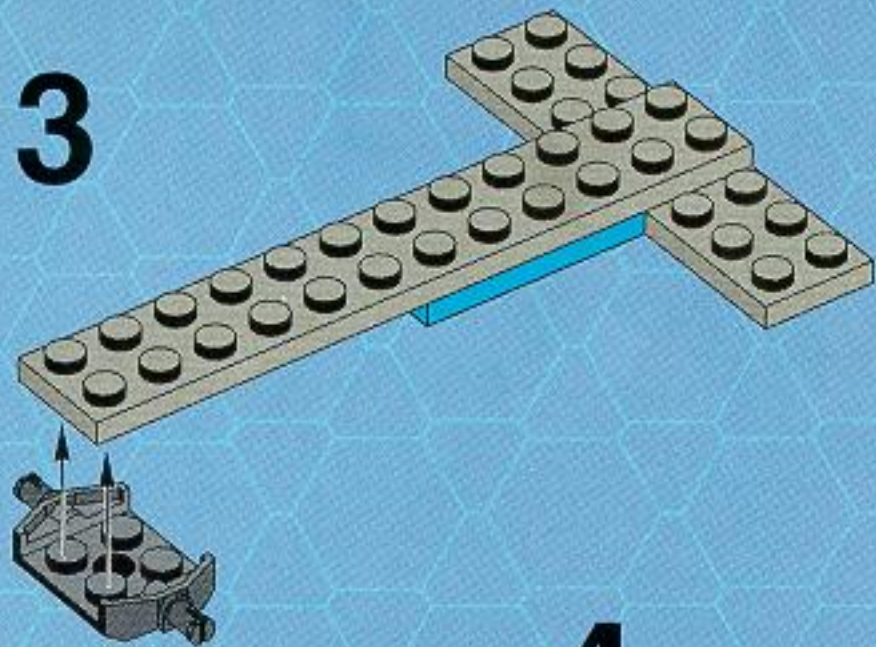

# 4

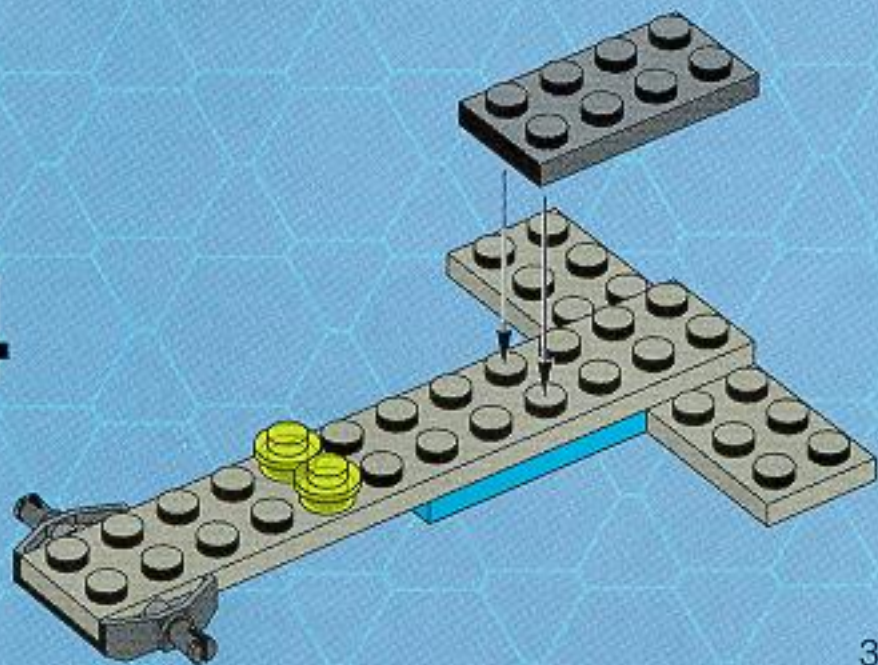



5

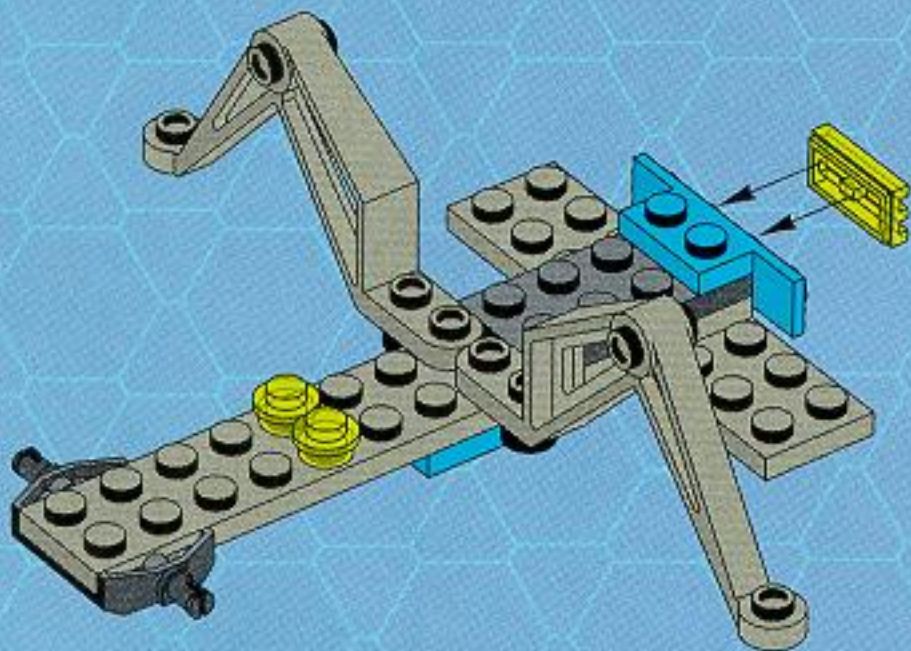

6

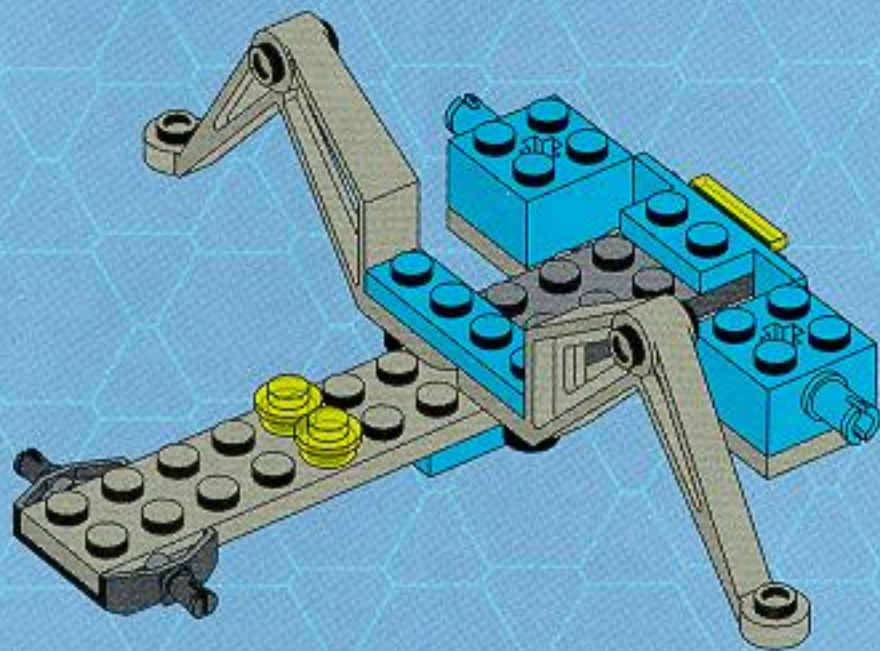



7

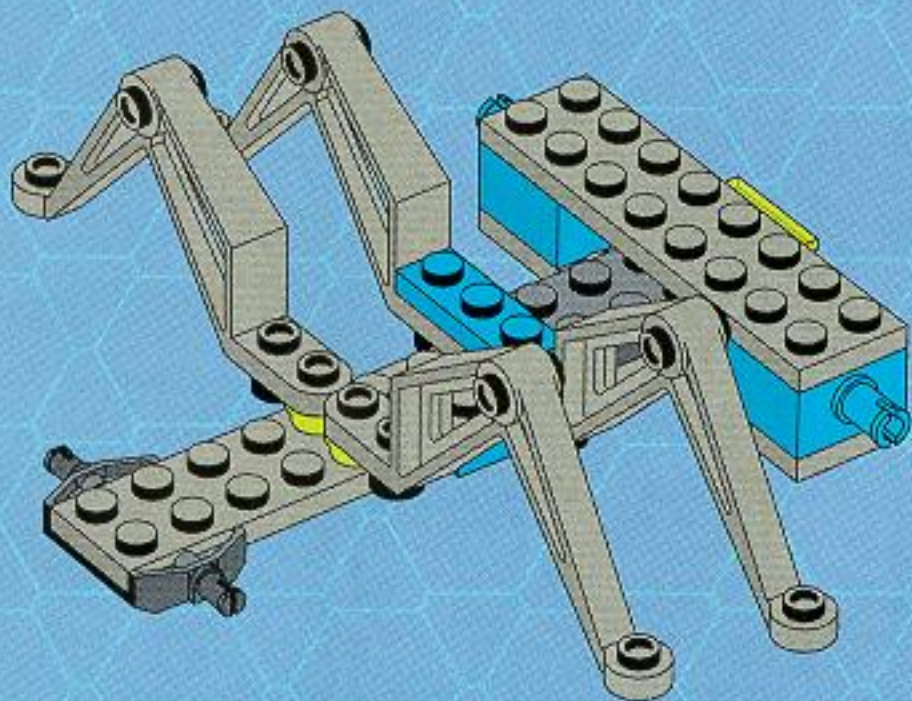

8

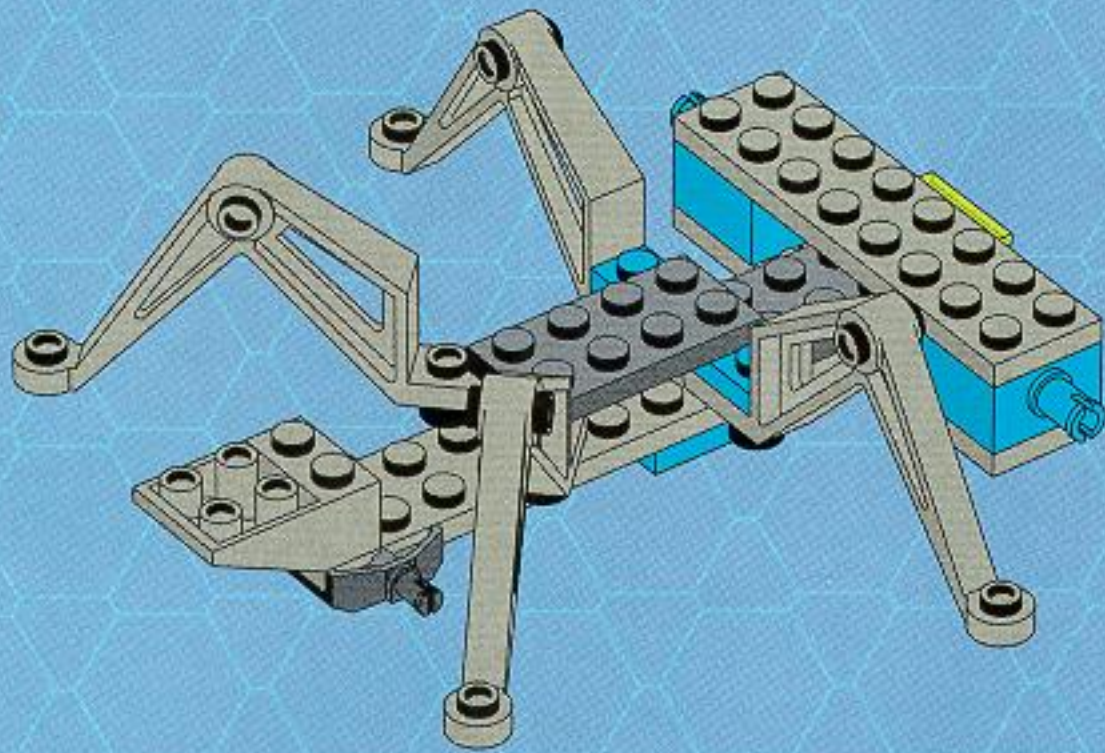







10

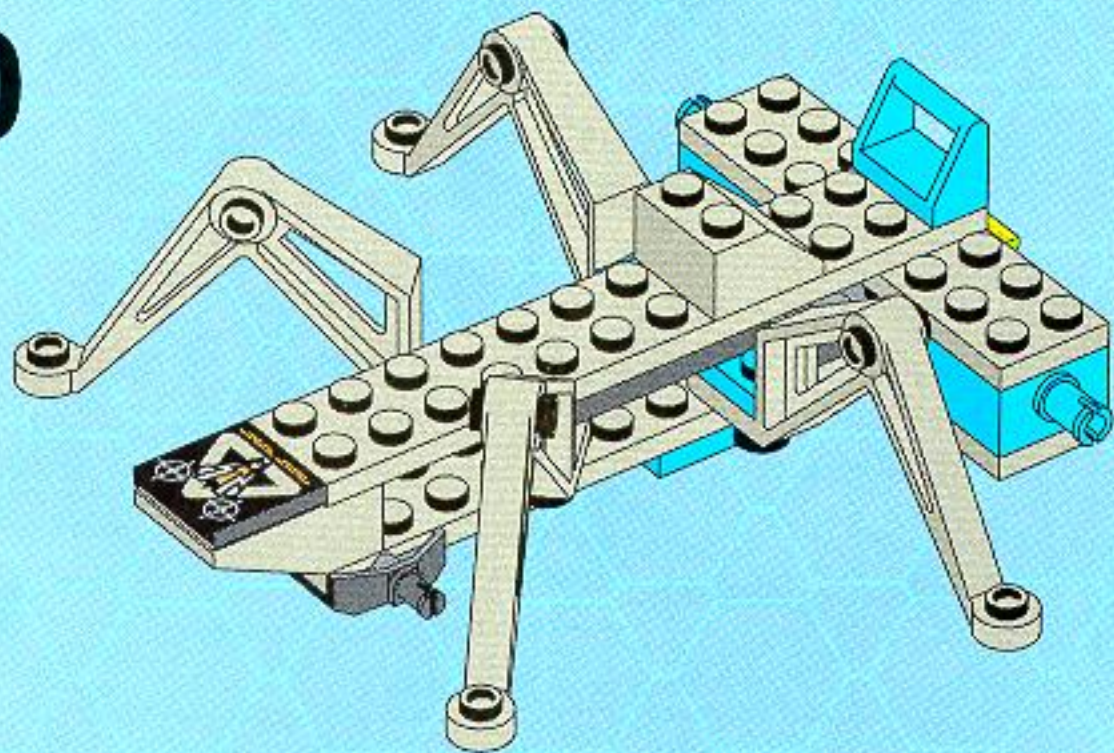



11

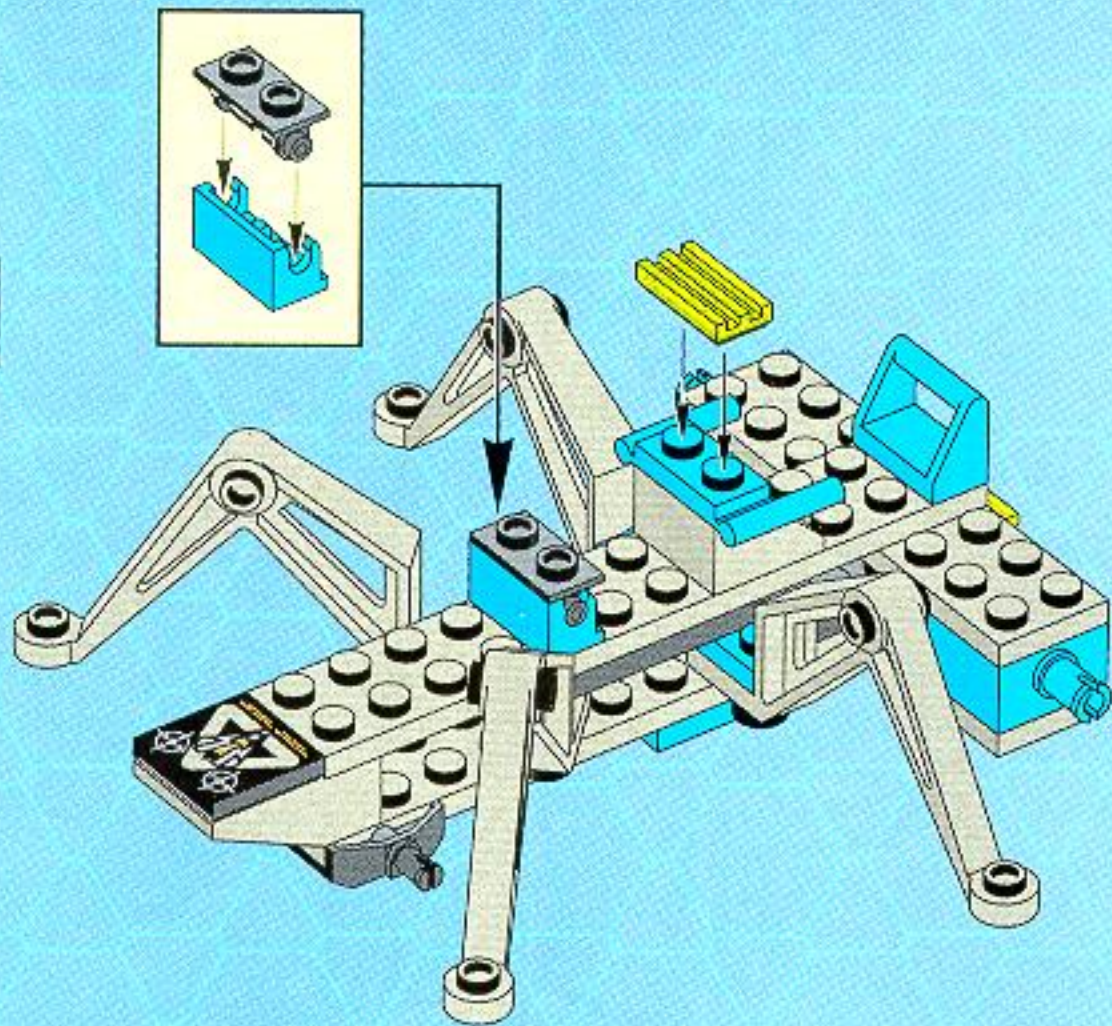

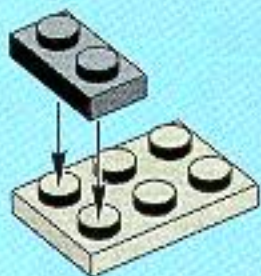
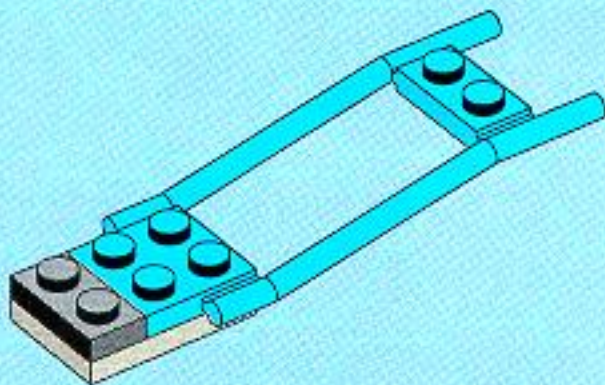
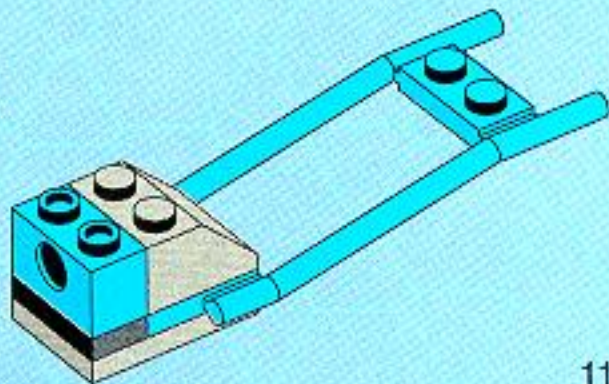

**1****2****3**

1

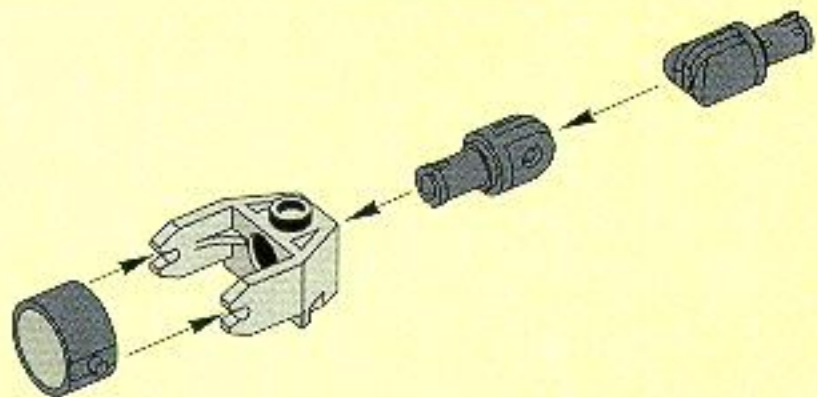

2

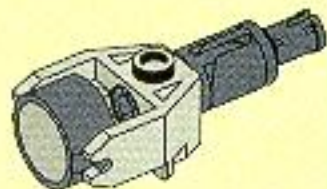

4

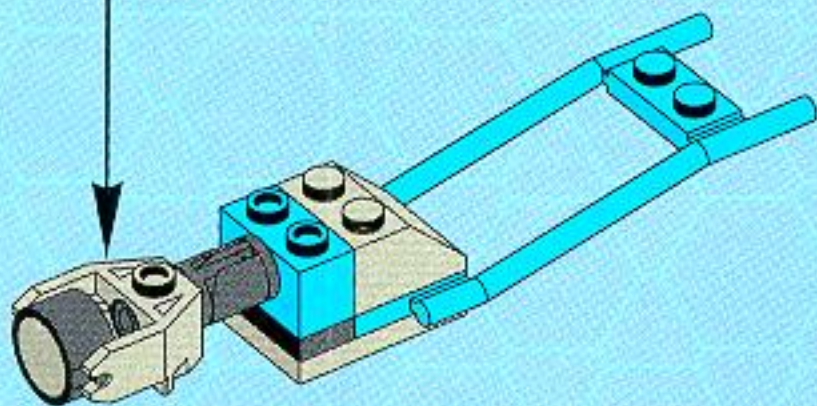



5

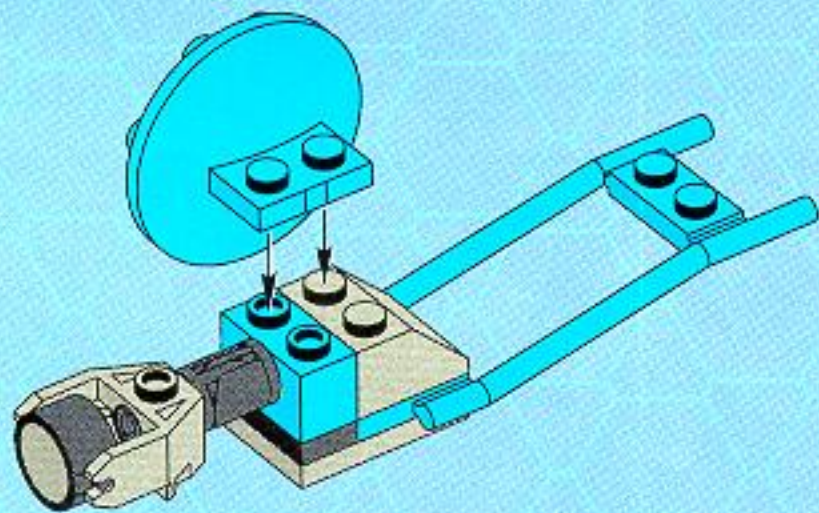

6

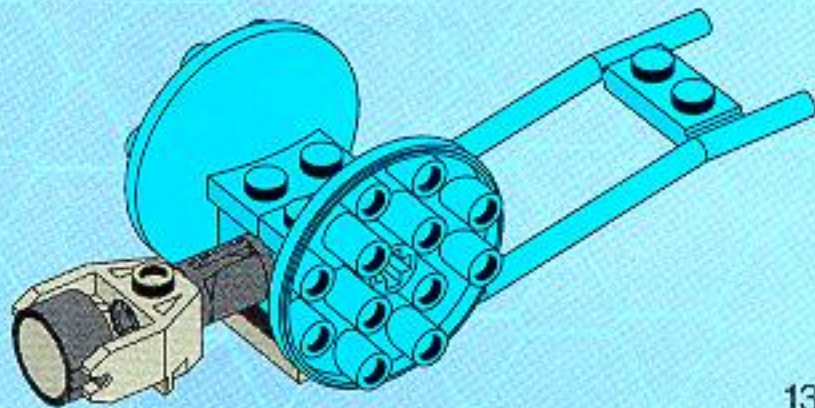



7

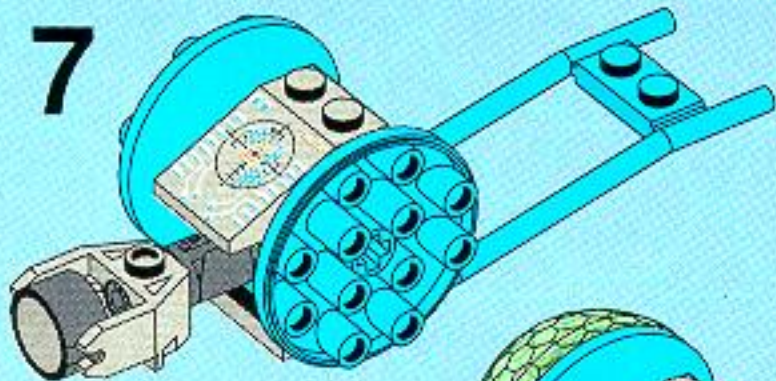

8

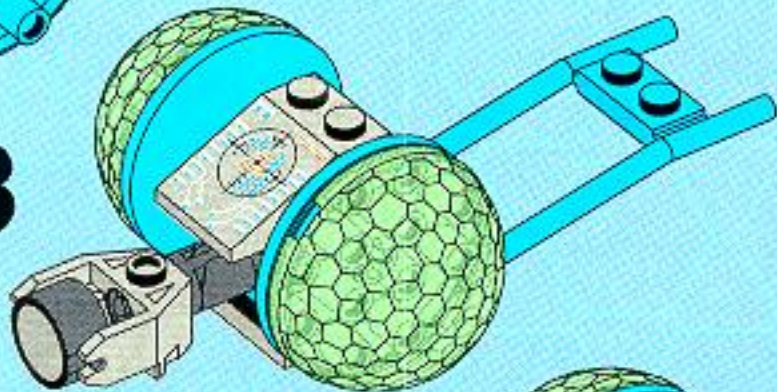

9

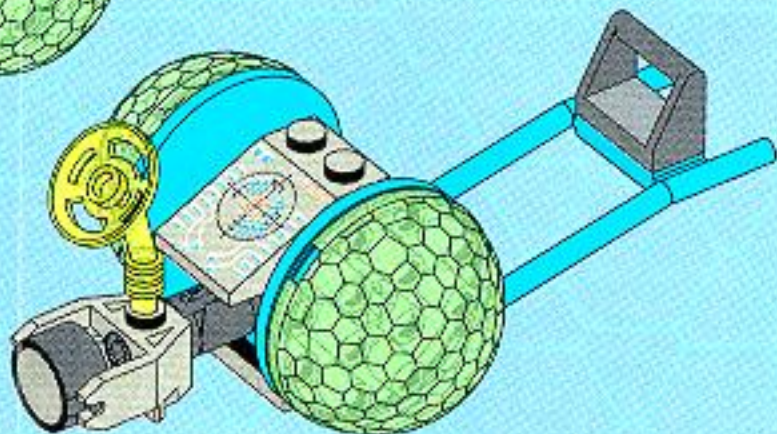



# 12

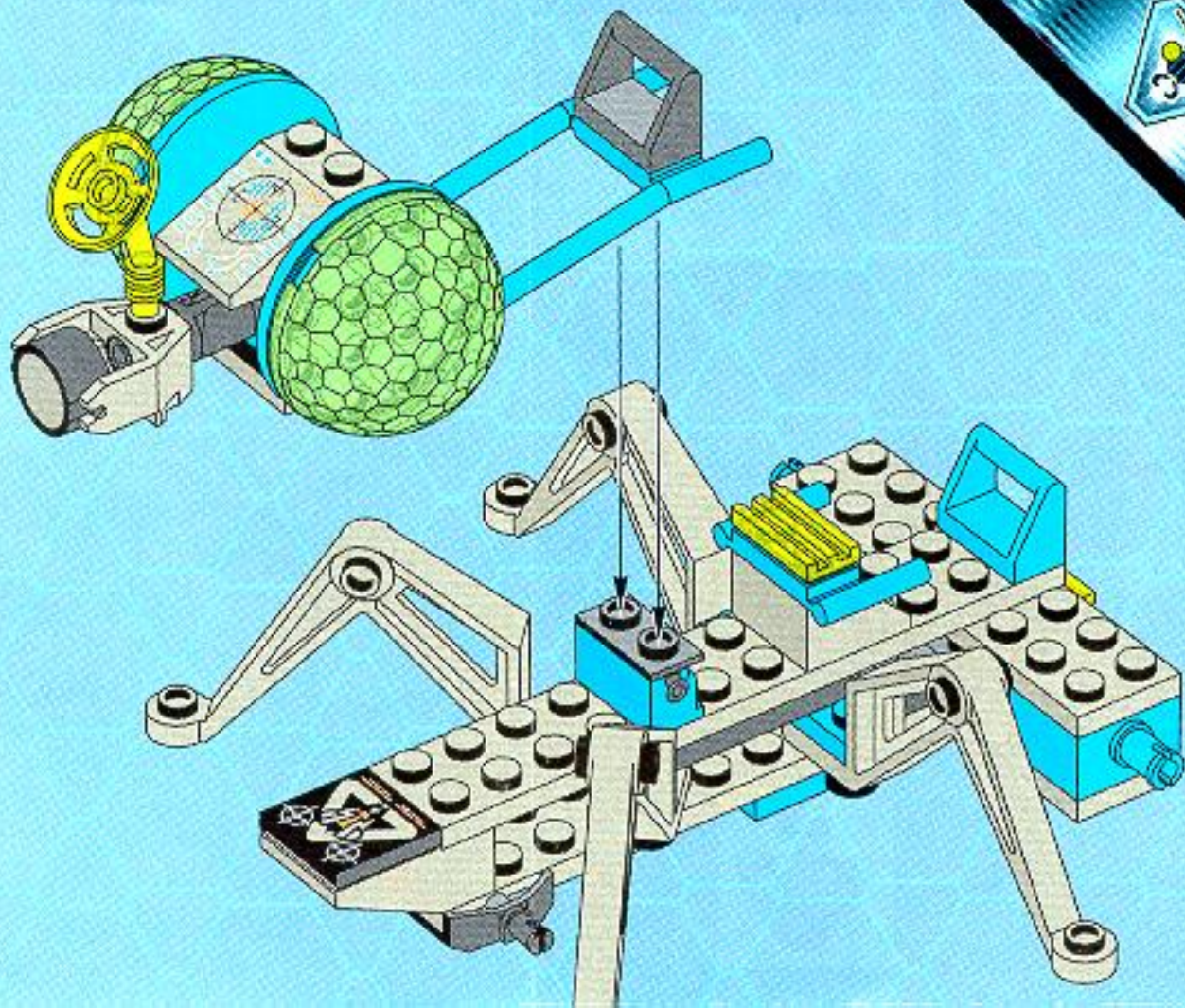



13

