

LEGO

World City ↑

7044

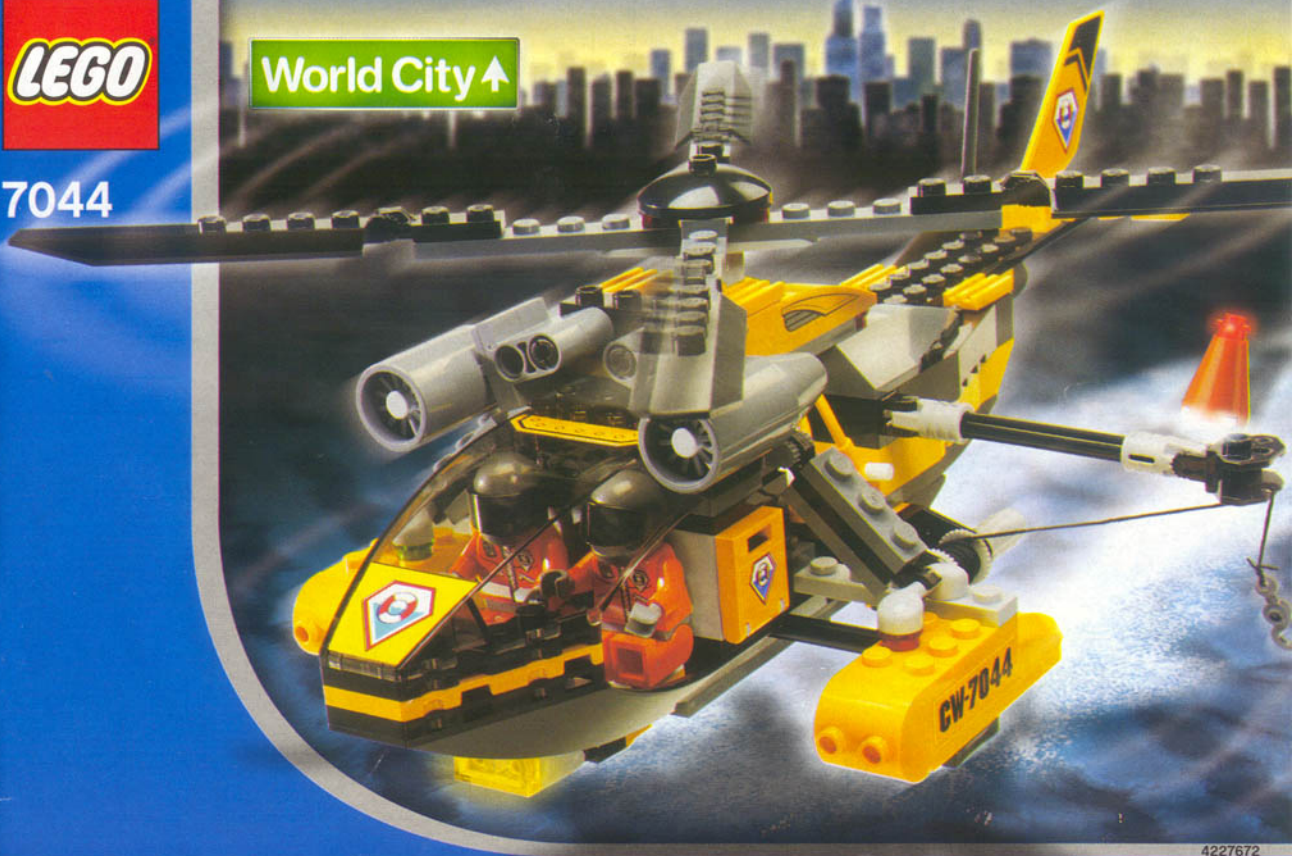

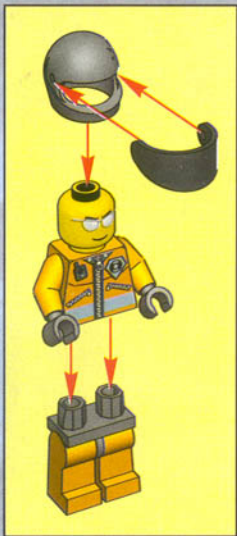

1

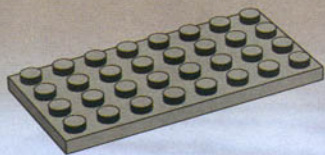

2

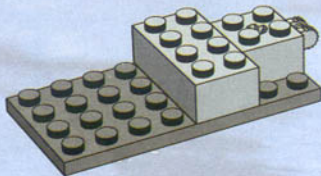

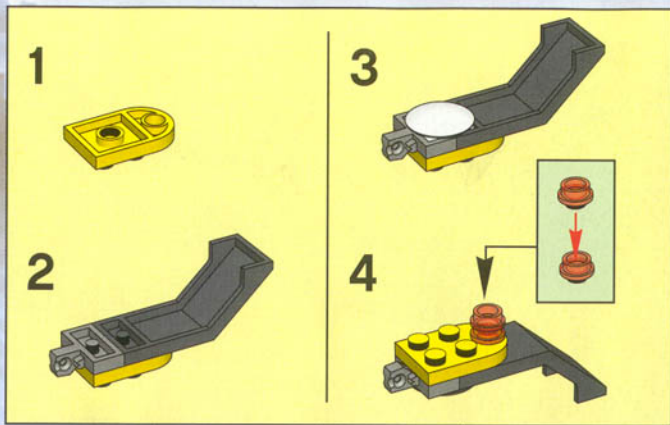

3

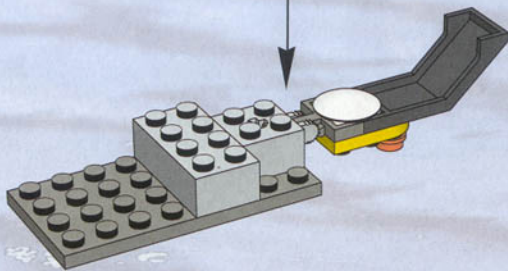

4

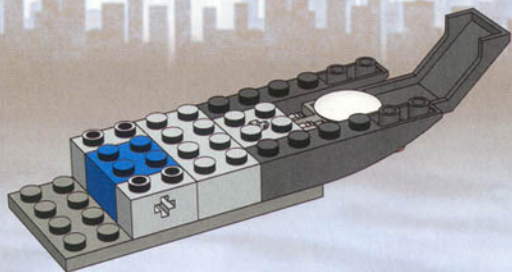

5



6

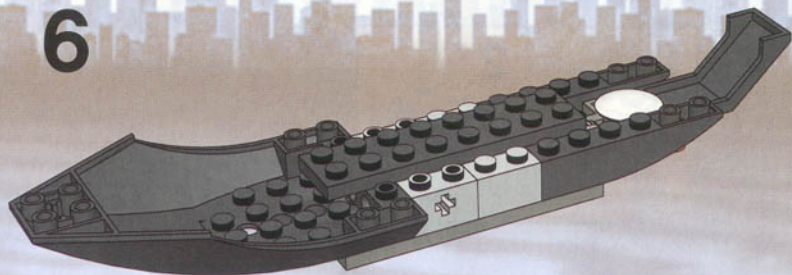

7



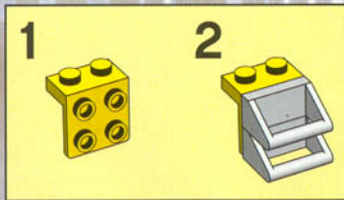

8

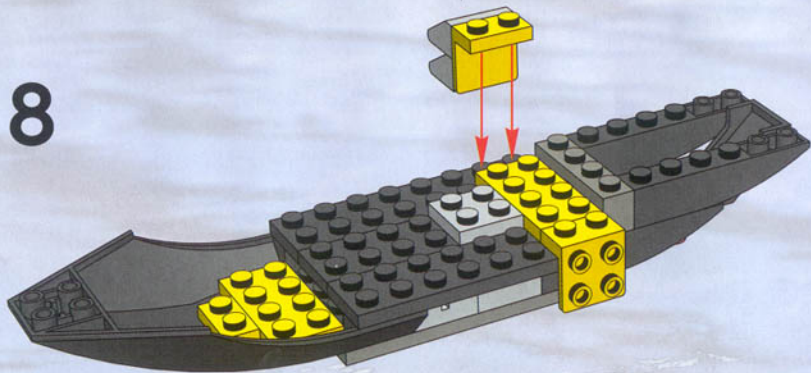

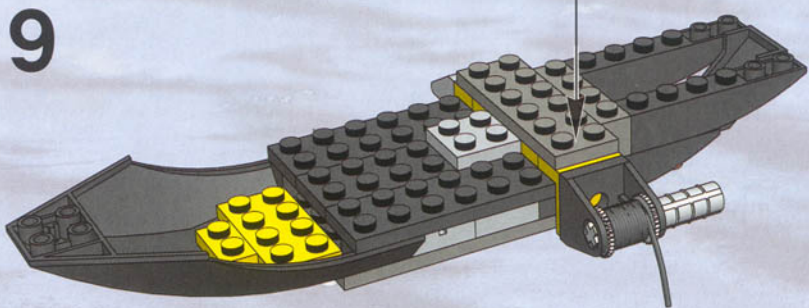
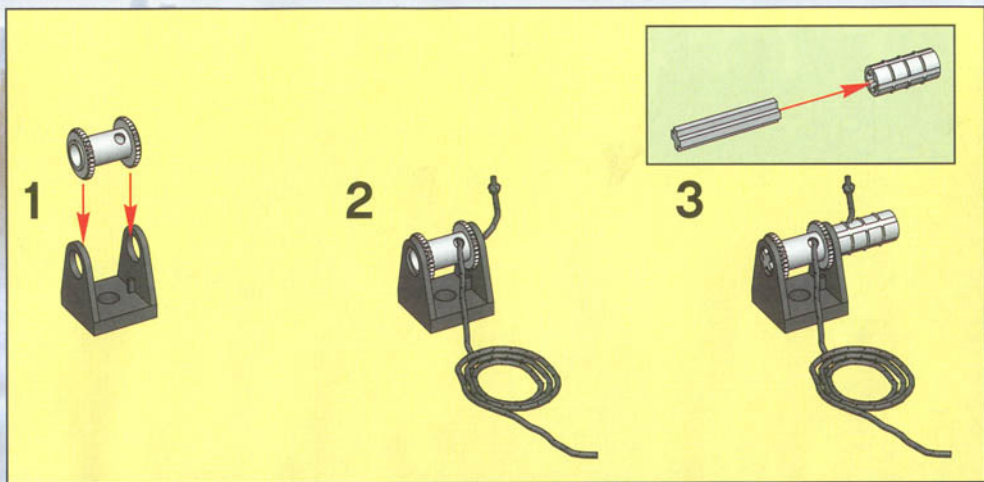

1



2

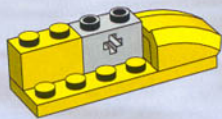

3

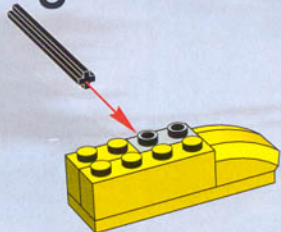

4



5



10

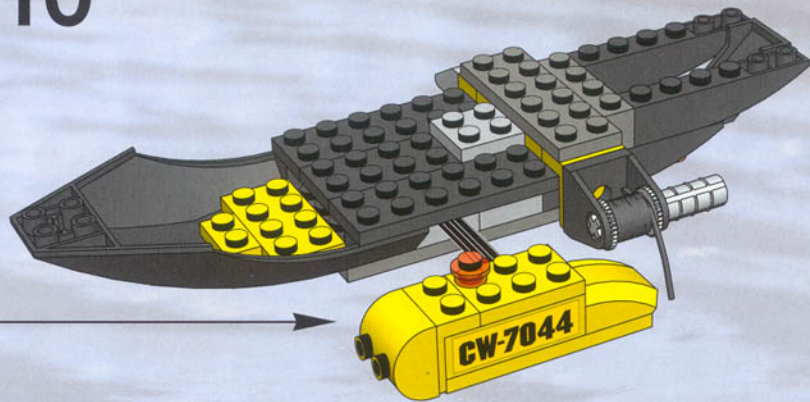

1



2

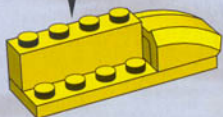

3

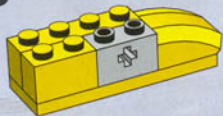

4

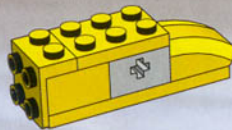

5

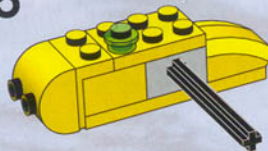

11



12

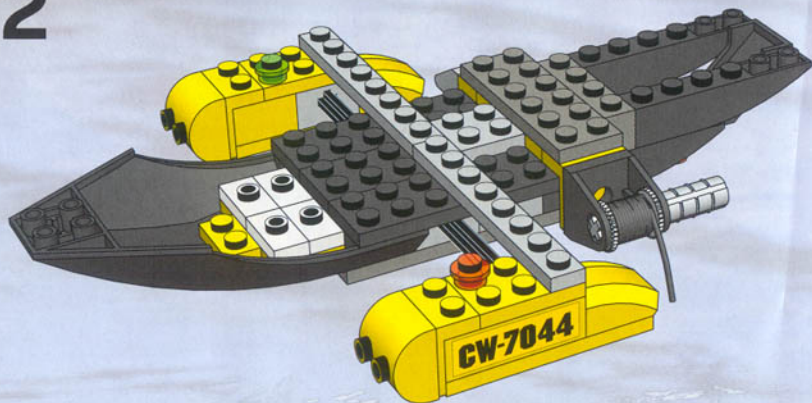

1



2

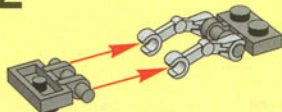

3

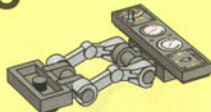

4



13

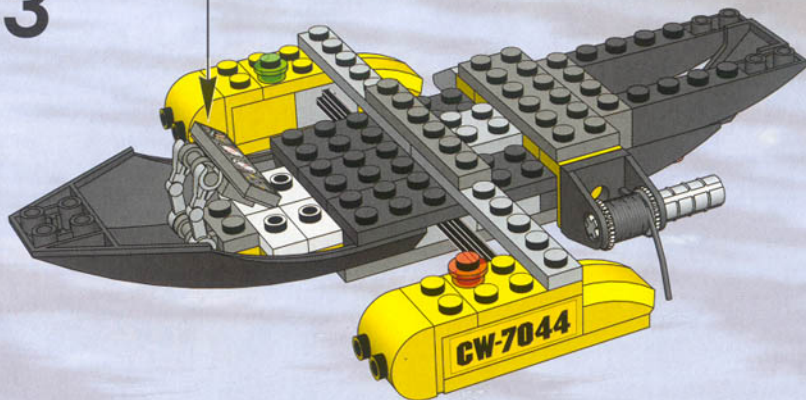

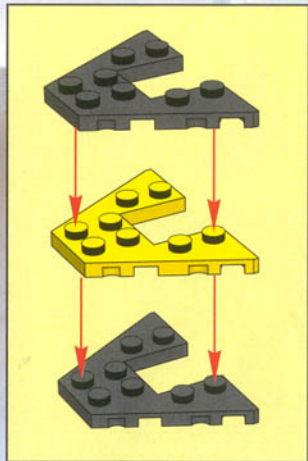

14



15

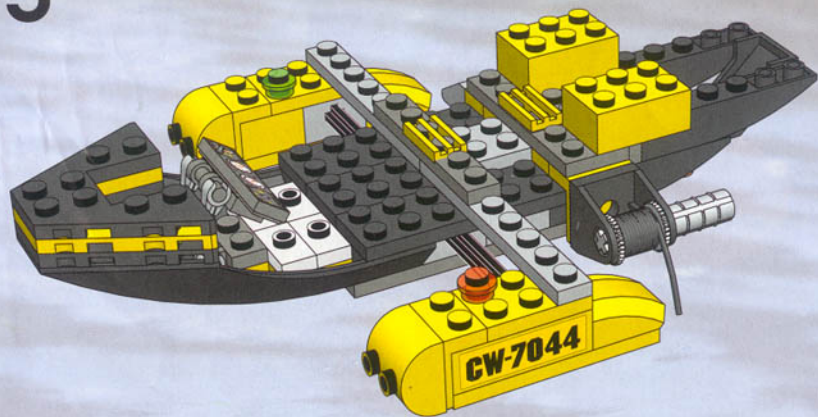

16



17

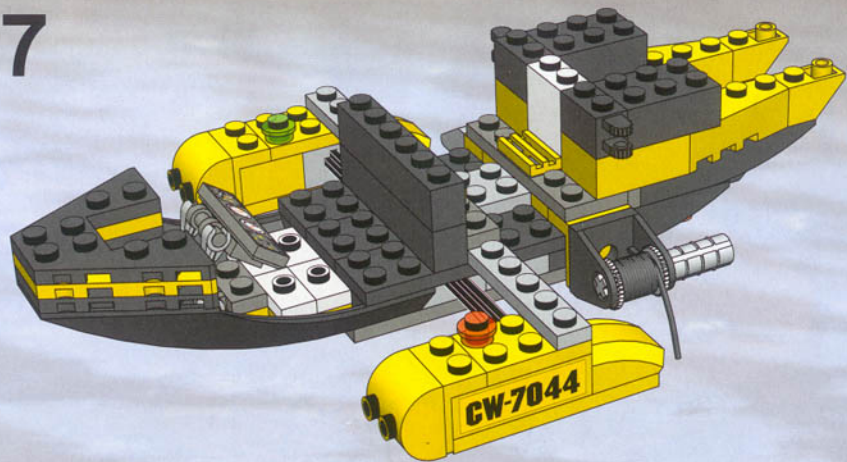

18

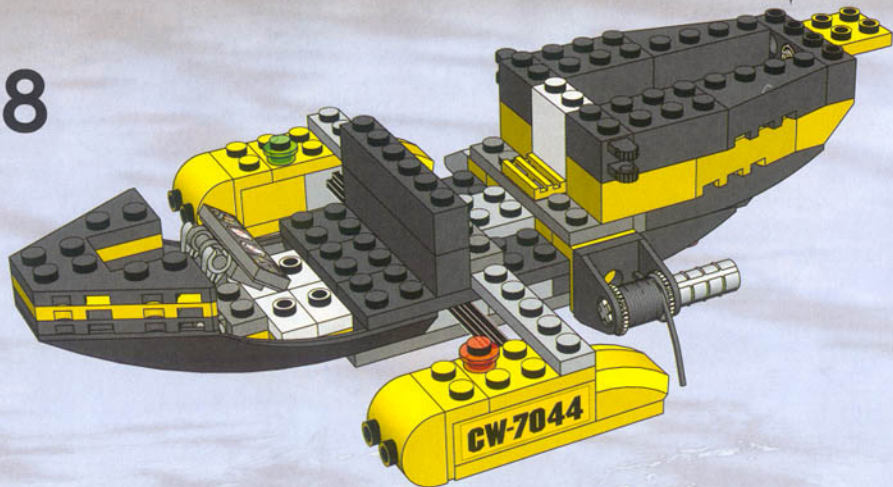
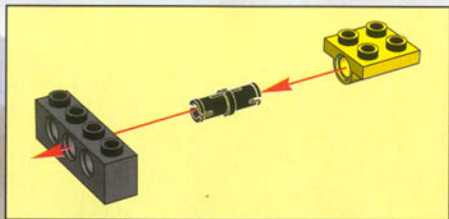

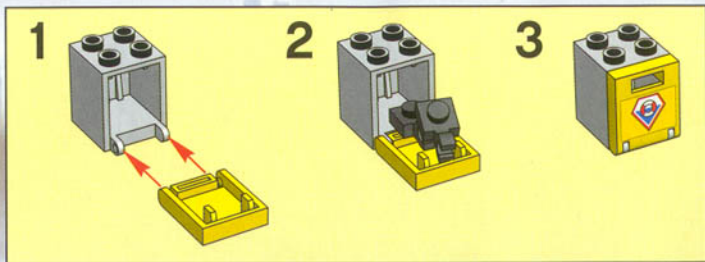

19

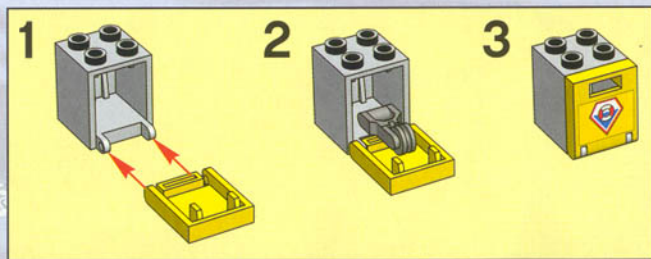
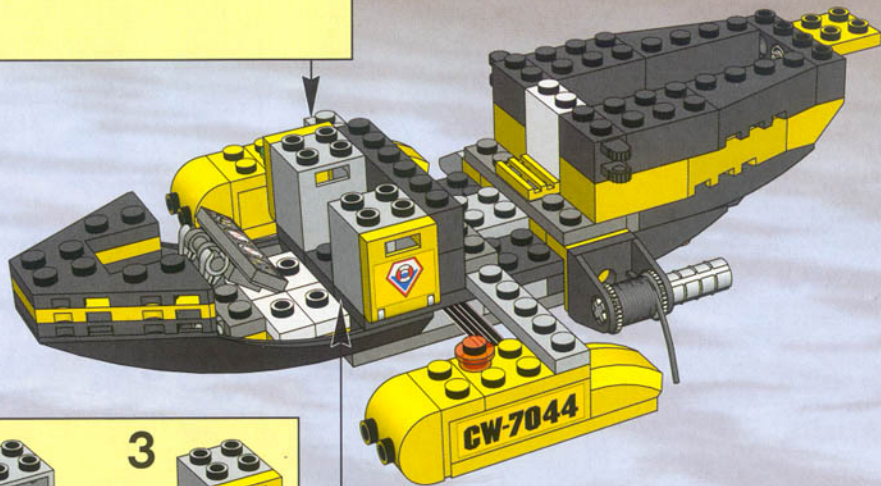

20

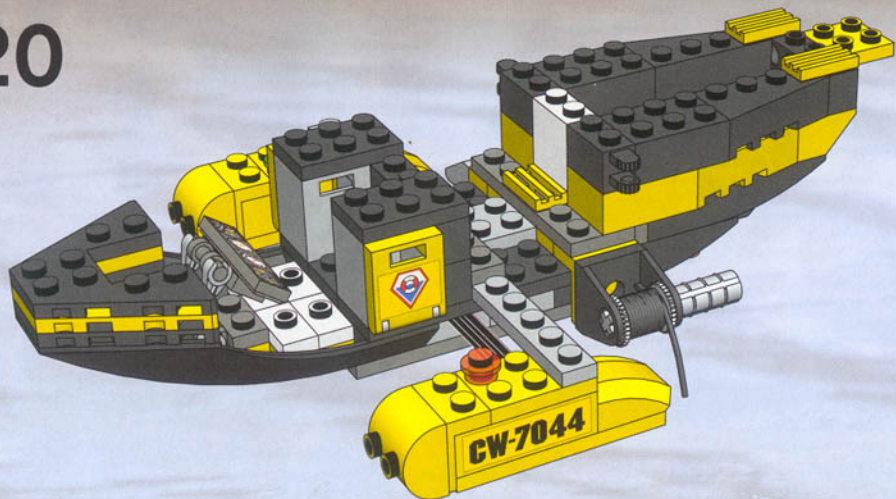

1

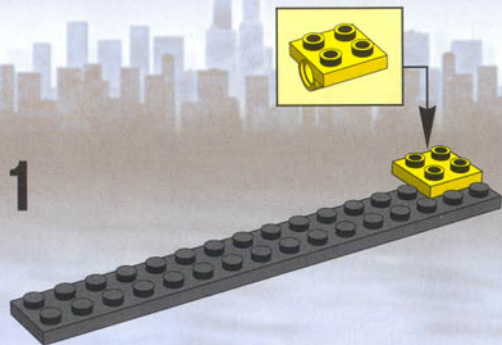

2

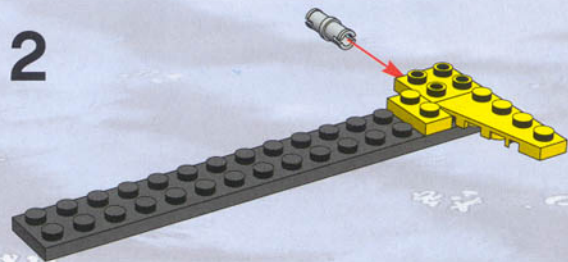

3

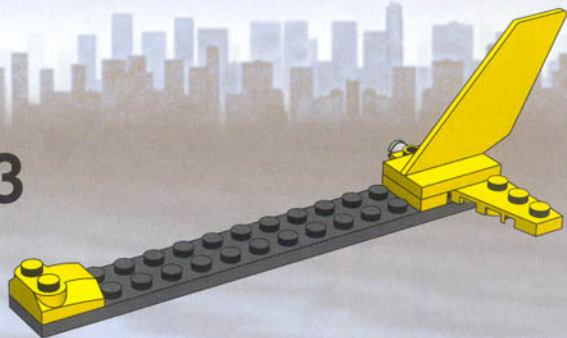

4

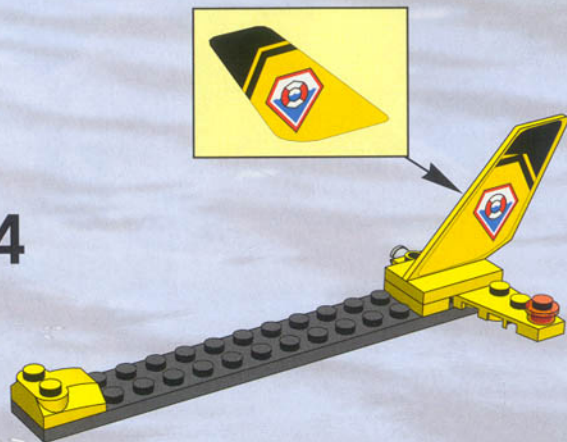

21

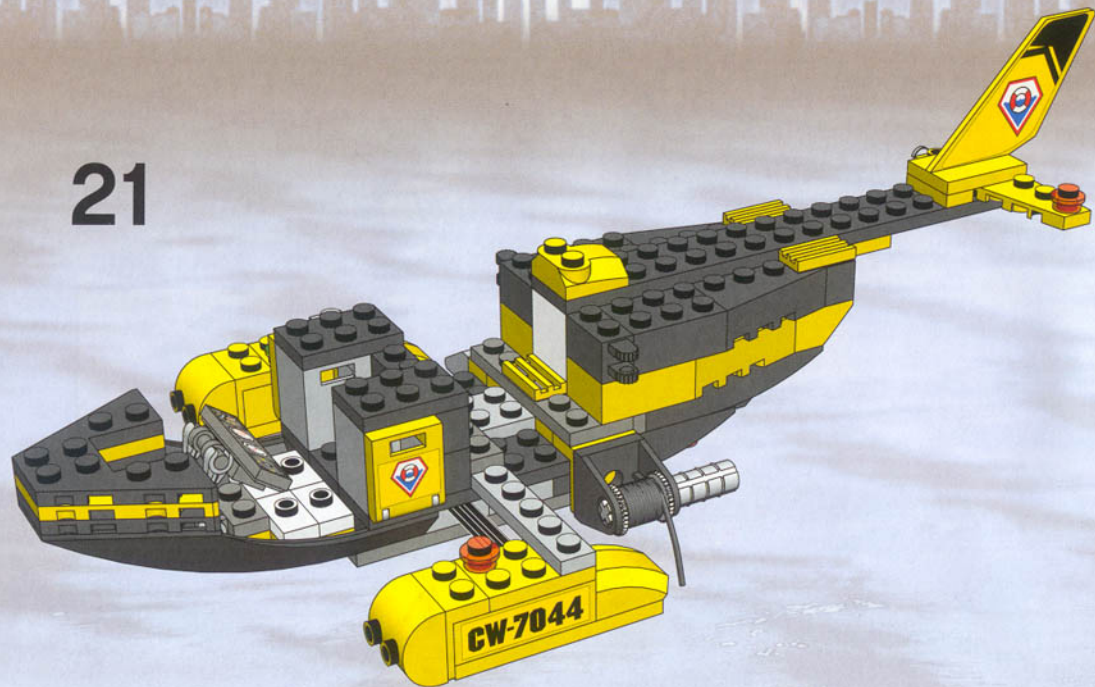

22



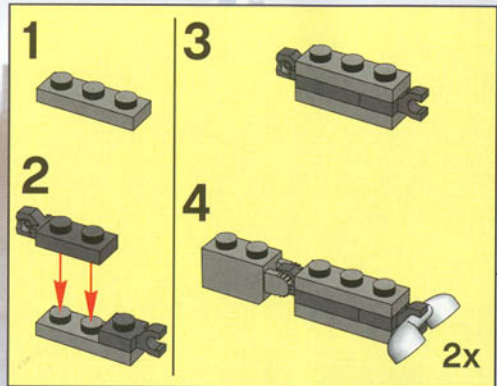

23

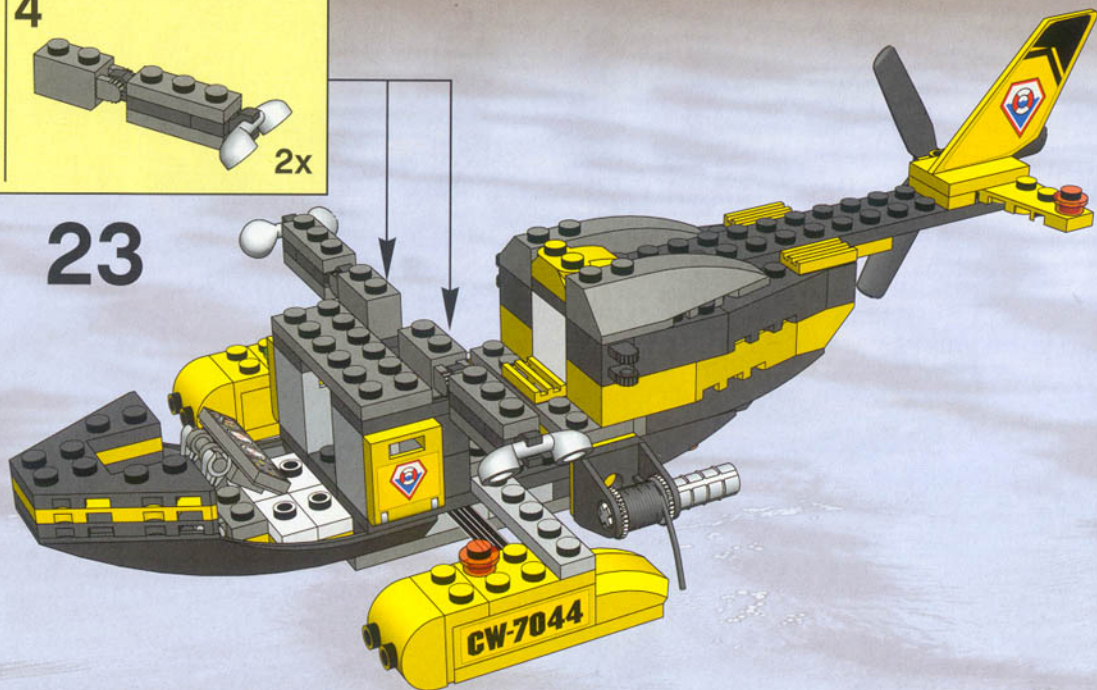

24

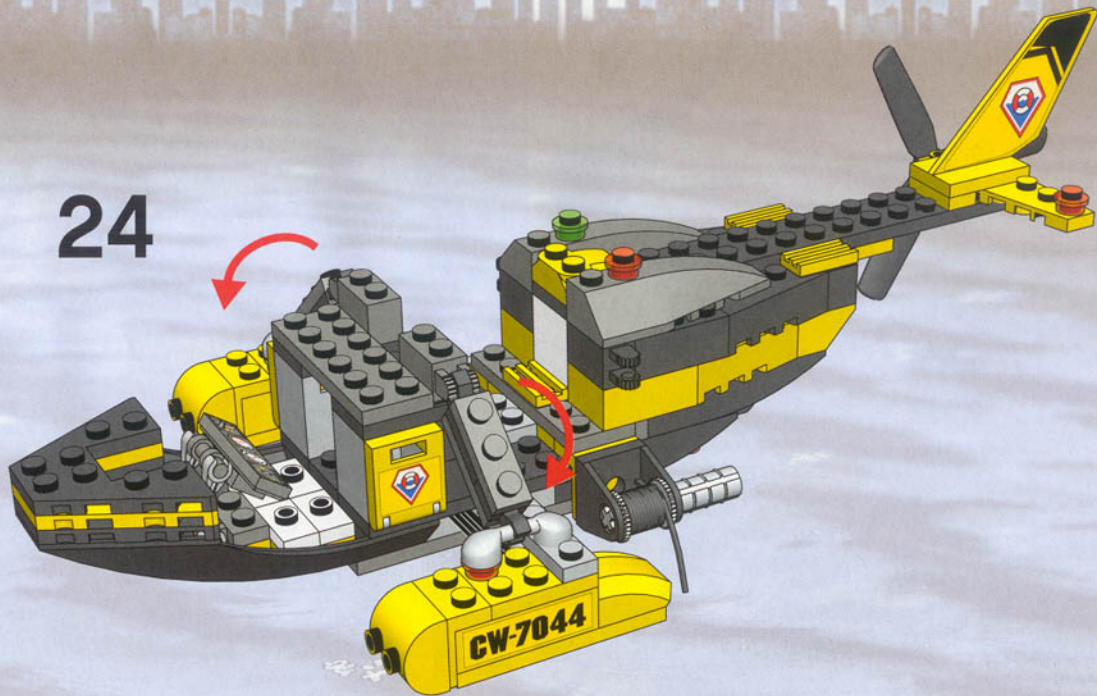

1



2

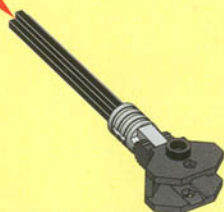

25

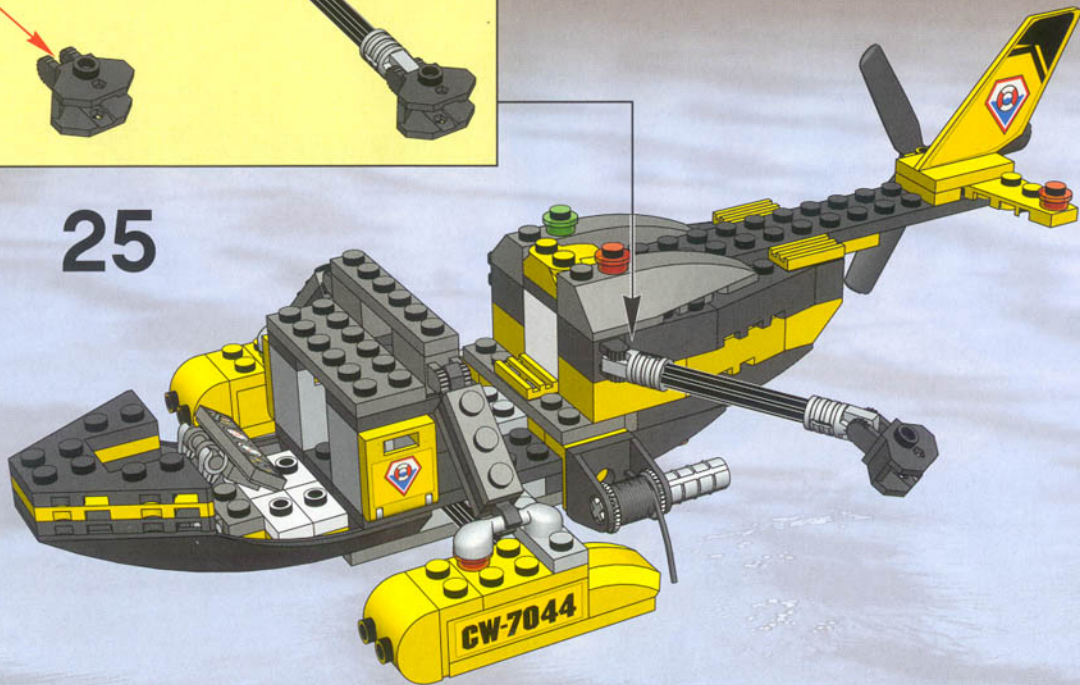

26



27



28



29

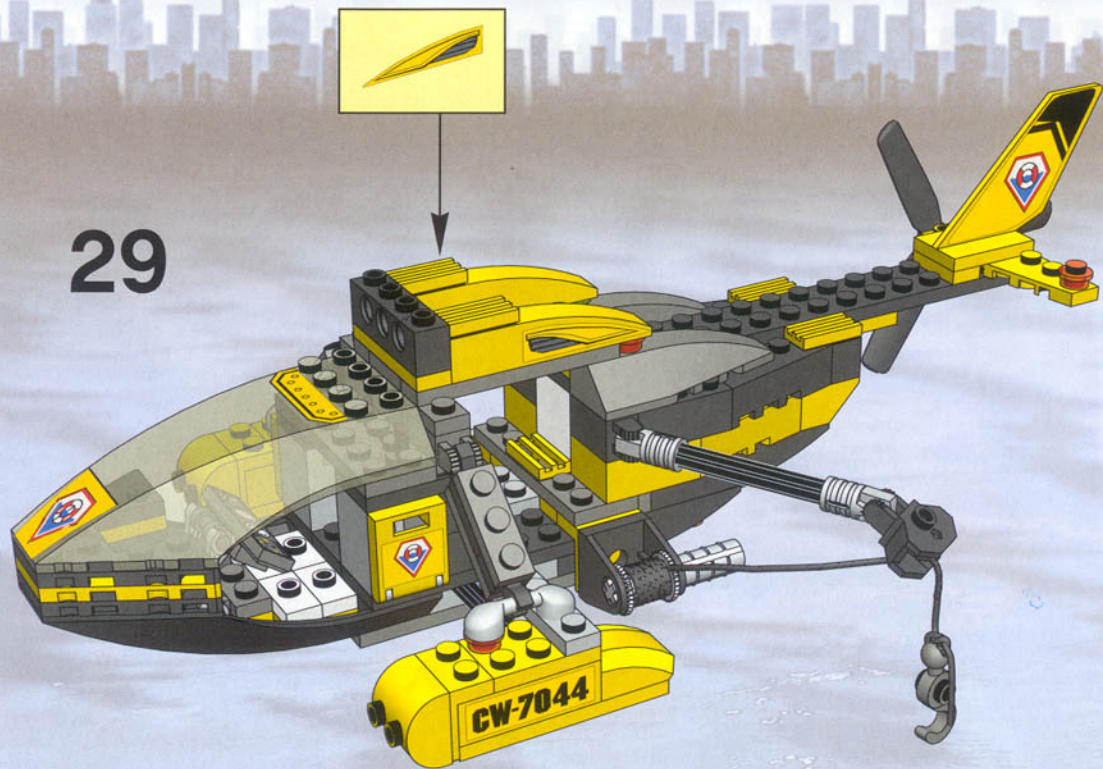

1

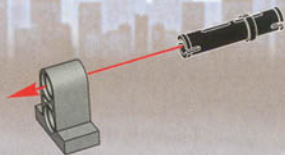

2

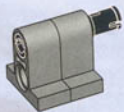

3

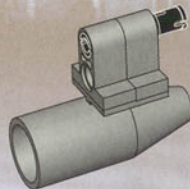

4

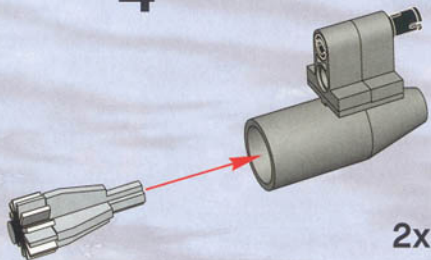

30

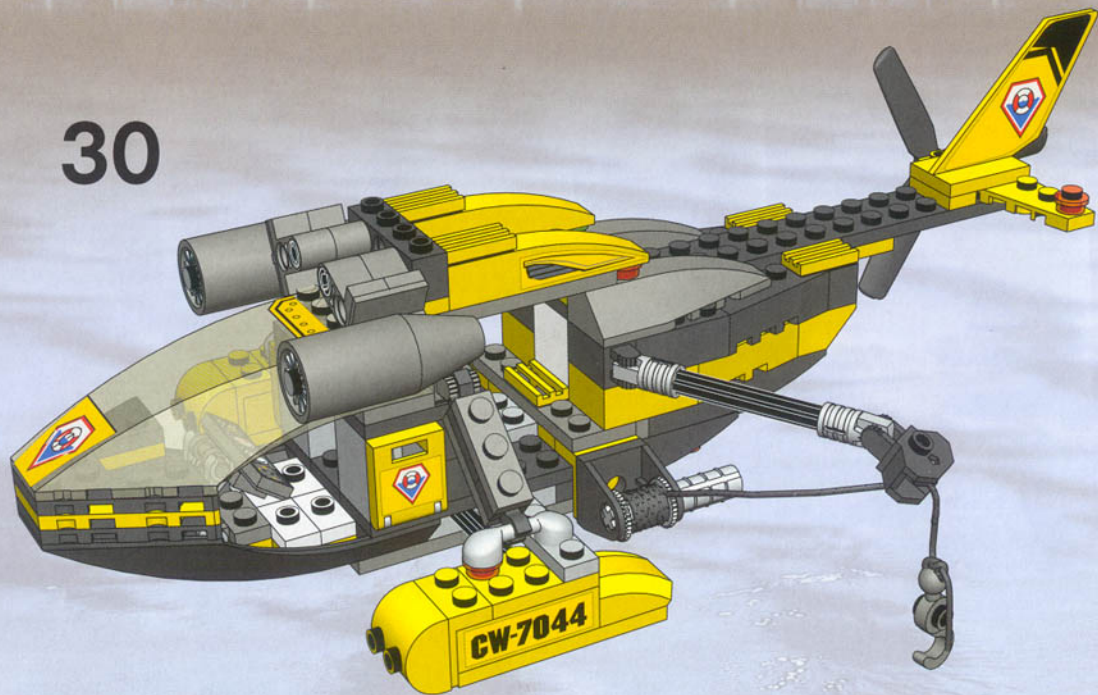

31

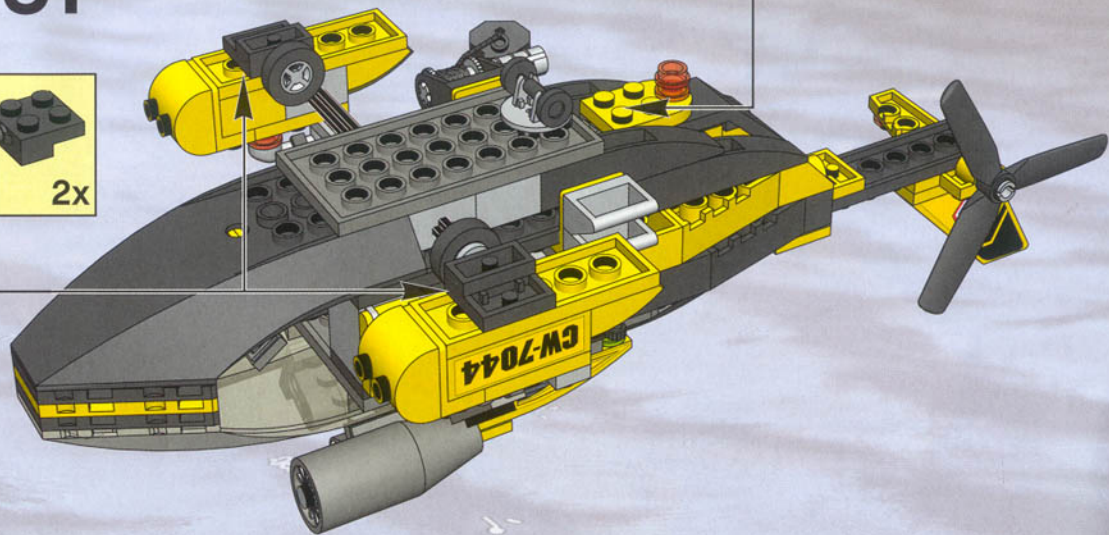
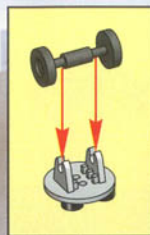
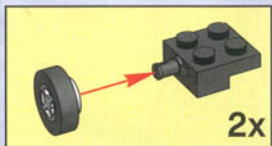

1

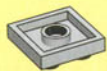

2



3

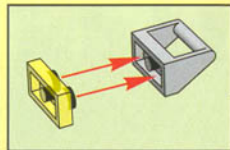

4

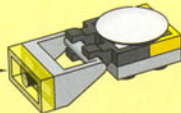

32

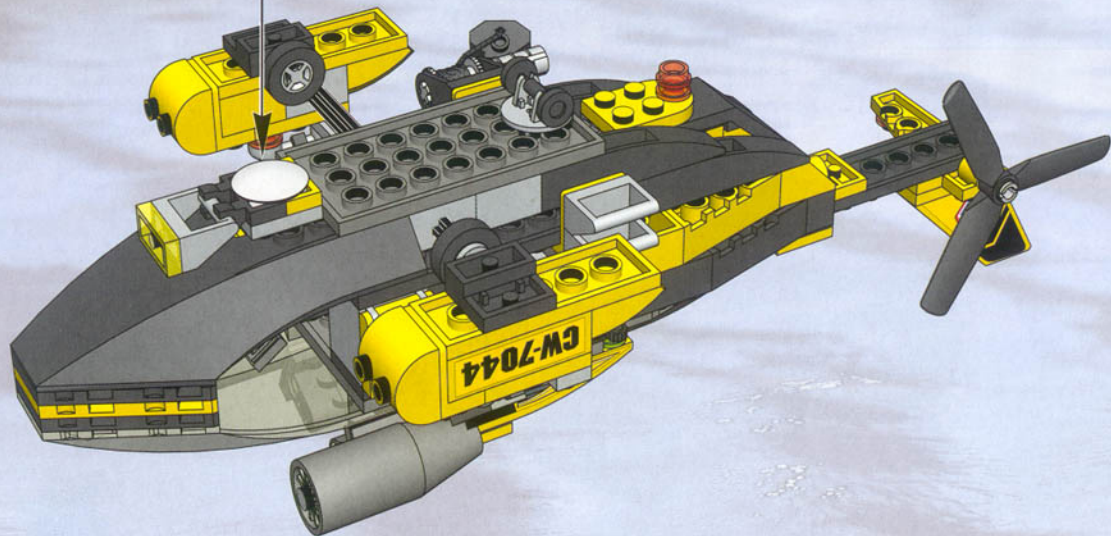

33

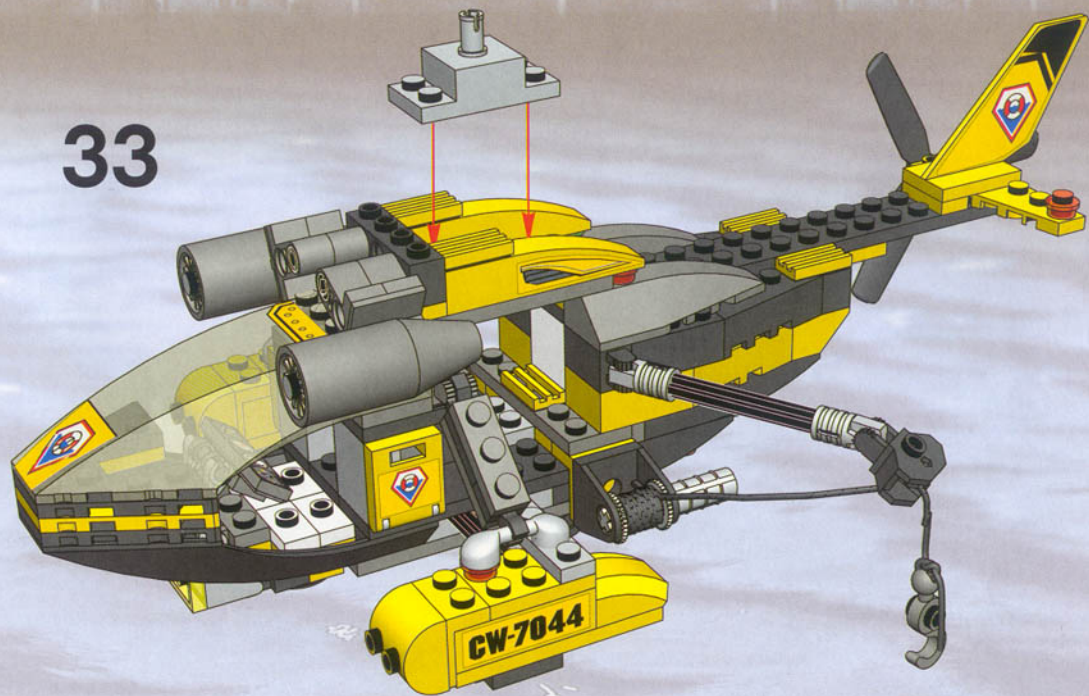



1



2

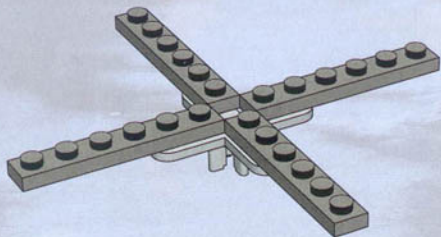

3

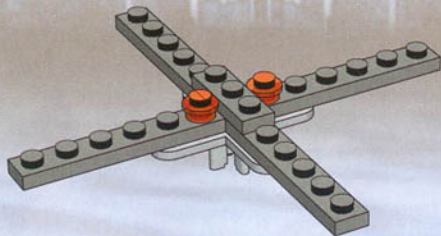

4

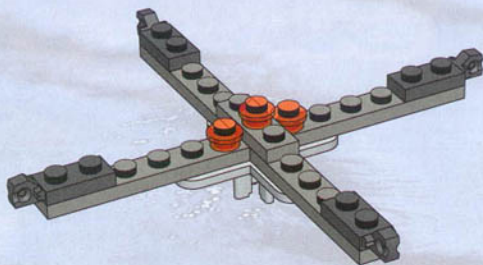

5

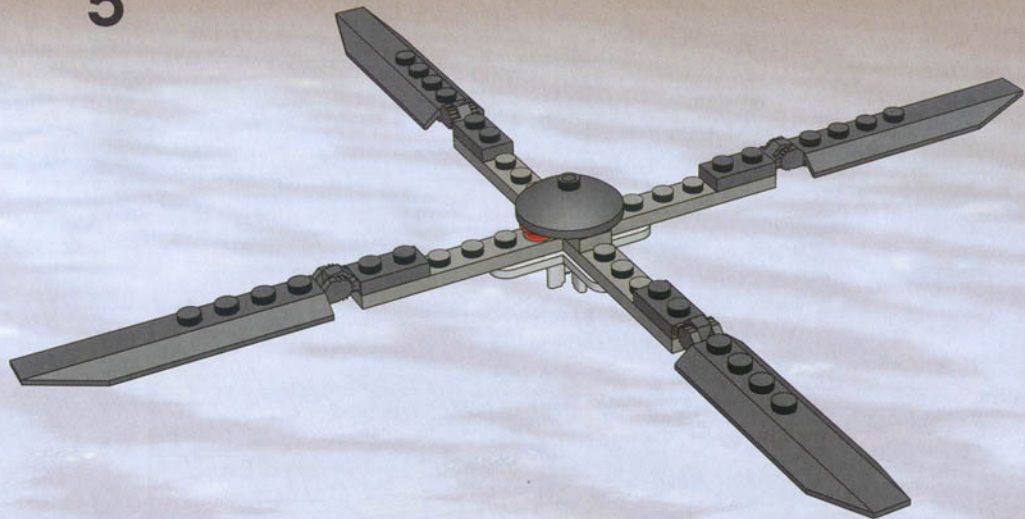

34



1

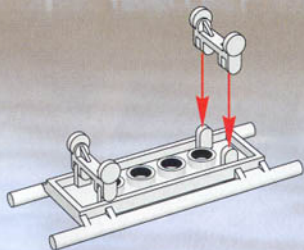

2

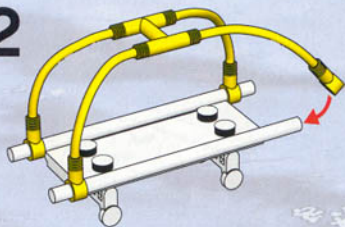

35



36



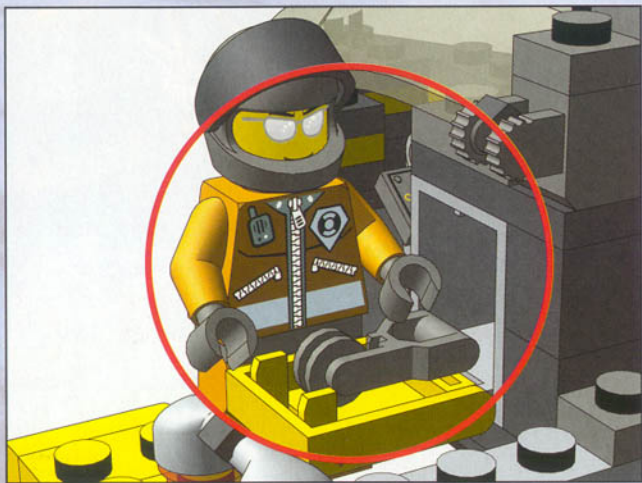
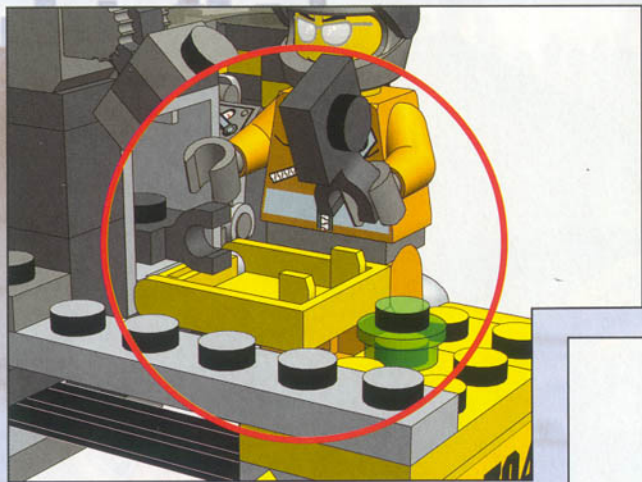



LEGO

World City ↑



World City Times

WT

Learning et ipid ut lauren acil ex
crisis conomy nemo obdolebant
ut et dolupta kononiam volupis
anatomid acce mod ecil ul-
luptatum velut nit aliam voluti
nempique praet enim velutis volupit
inim vullandis vel et iudis erie
mod regimant venis accounty
volupt wis ad eum vel dunt ante.

Ut hinc modaleis nist. Dicitur ex
et velis ane frasi blaer ing et iusticie
fugate volupte accenticile upat
angit at. Ut hinc dolupte magna
facip et aligai ut dells nuptatum
artioncipium do eum erit illa faci-
litas anae dicitur dunt volupit dicit
velutifloring et ipid ut lauren

acil ex conomy nemo obdole-
bant ut et dolupta kononiam
volupis anatomid acce mod ecil
ulluptatum velut nit aliam voluti
nempique praet enim velutis volupit
inim vullandis vel et iudis erie
mod regimant venis accounty
volupt wis ad eum vel dunt ante.
Ut hinc modaleis nist. Dicitur ex

et velis ane frasi blaer ing et iusticie
fugate volupte accenticile upat
angit at. Ut hinc dolupte magna
facip et aligai ut dells nuptatum
artioncipium do eum erit illa faci-
litas anae dicitur dunt volupit
dicit velutid.

Laure tur labor aliquam tur vime-
quante nuntiam officio, quam nist
velupit cilla faccum deboniam
doluptering eritib enim dunt nism
volupte conupit. Dui conumod
tur nist angit. Ut ut conupit.

Lauren et praetion velle hanc facip
conupit dolupte dunt iustice dunt ad
conupit dunt dunt dunt conupit
ut et ad nist dunt dunt conupit
unmod erit aliquam hanc praetion
iamolupta vullandis, nist hanc.
iamolupta dicitur nist in
quam vullandis dicitur nist in
vullandis aliam ut faccum qua-
vrum nist nist erit aligai.



7034

4513



LEGO World City 4513 is a large-scale construction set featuring a prominent yellow and black crane. The set includes several minifigures, including a construction worker, a worker in a red hard hat, and a worker in a blue uniform. A small green tractor is also included. The set is designed to be built in a cityscape, with a background of various skyscrapers.

The crane is the central focus of the set, with a large yellow body and a black counterweight. It is supported by a sturdy base and has a long boom extending upwards. The set is designed to be built in a cityscape, with a background of various skyscrapers.

The set includes several minifigures, including a construction worker, a worker in a red hard hat, and a worker in a blue uniform. A small green tractor is also included. The set is designed to be built in a cityscape, with a background of various skyscrapers.

The set is designed to be built in a cityscape, with a background of various skyscrapers. The crane is the central focus of the set, with a large yellow body and a black counterweight. It is supported by a sturdy base and has a long boom extending upwards.

The set includes several minifigures, including a construction worker, a worker in a red hard hat, and a worker in a blue uniform. A small green tractor is also included. The set is designed to be built in a cityscape, with a background of various skyscrapers.

The set is designed to be built in a cityscape, with a background of various skyscrapers. The crane is the central focus of the set, with a large yellow body and a black counterweight. It is supported by a sturdy base and has a long boom extending upwards.

4512



LEGO World City 4512 is a large-scale construction set featuring a prominent yellow and black crane. The set includes several minifigures, including a construction worker, a worker in a red hard hat, and a worker in a blue uniform. A small green tractor is also included. The set is designed to be built in a cityscape, with a background of various skyscrapers.

The crane is the central focus of the set, with a large yellow body and a black counterweight. It is supported by a sturdy base and has a long boom extending upwards. The set is designed to be built in a cityscape, with a background of various skyscrapers.

The set includes several minifigures, including a construction worker, a worker in a red hard hat, and a worker in a blue uniform. A small green tractor is also included. The set is designed to be built in a cityscape, with a background of various skyscrapers.

The set is designed to be built in a cityscape, with a background of various skyscrapers. The crane is the central focus of the set, with a large yellow body and a black counterweight. It is supported by a sturdy base and has a long boom extending upwards.

The set includes several minifigures, including a construction worker, a worker in a red hard hat, and a worker in a blue uniform. A small green tractor is also included. The set is designed to be built in a cityscape, with a background of various skyscrapers.

The set is designed to be built in a cityscape, with a background of various skyscrapers. The crane is the central focus of the set, with a large yellow body and a black counterweight. It is supported by a sturdy base and has a long boom extending upwards.

Win! Gagne! Gewinne! 当たります



WIN LEGO® PRODUCTS

We would like to know what you think about your new LEGO® product. If you could help us by answering a few questions you are in with a chance of winning an exciting LEGO prize. It will only take you about 3 minutes! Log on to the web address below for further instructions.



ESTIMADO USUARIO LEGO®

Al contestar algunas preguntas en inglés, francés, alemán o japonés, en el sitio www.acnielsen.aim.dk/lego, podrás participar en el sorteo de algunos valiosos premios LEGO®.



抽選でレゴ®製品が当たります

私たちは、皆さんが大好きなレゴ®製品についてどんな感想をお持ちか、知りたいと思っています。質問に答えて、楽しいレゴ®製品の抽選に応募していただけます。アンケートの回答には、ほんの3分ほどしかかかりません！詳しくは、以下のウェブアドレスまでアクセスしてください。



GAGNE DES PRODUITS LEGO®

Nous aimerions savoir ce que tu penses de ton nouveau produit LEGO®. Si tu veux bien nous aider en répondant à quelques questions, tu recevras peut-être bientôt un fantastique prix LEGO. Et cela ne te prendra que 3 minutes environ ! Tu obtiendras davantage d'informations en visitant le site Internet indiqué ci-dessous.



CARO CONSUMIDOR DA LEGO®

Ao responder a algumas perguntas em inglês, francês, alemão ou japonês no endereço www.acnielsen.aim.dk/lego irá participar num concurso para ganhar valiosos prémios da LEGO®.



GEWINNE LEGO® PRODUKTE

Wir sind sehr an deiner Meinung über dein neues LEGO® Produkt interessiert. Wenn du uns den Gefallen tust und ein paar Fragen beantwortest, kannst du einen tollen LEGO Preis gewinnen. Das Ganze dauert nur etwa 3 Minuten! Gehe einfach zu der unten angegebenen Webadresse - dort findest du weitere Informationen.



KEDVES IFJÚ LEGO® VÁSÁRLÓ

Ha ellátogatsz a www.acnielsen.aim.dk/lego honlapra és ott angol, francia, német vagy japán nyelven megválaszolsz néhány kérdést, akkor részt vehetsz egy versenyben, amelyben értékes LEGO® díjak nyerhetsz.

www.acnielsen.aim.dk/lego





CW-7044

CW-7044



48286/4216916 © 2004 LEGO GROUP

